

# TA1 Onkyo Multimedia Sound System / Receiver

## Remote Controller

### Controlling the AV Receiver

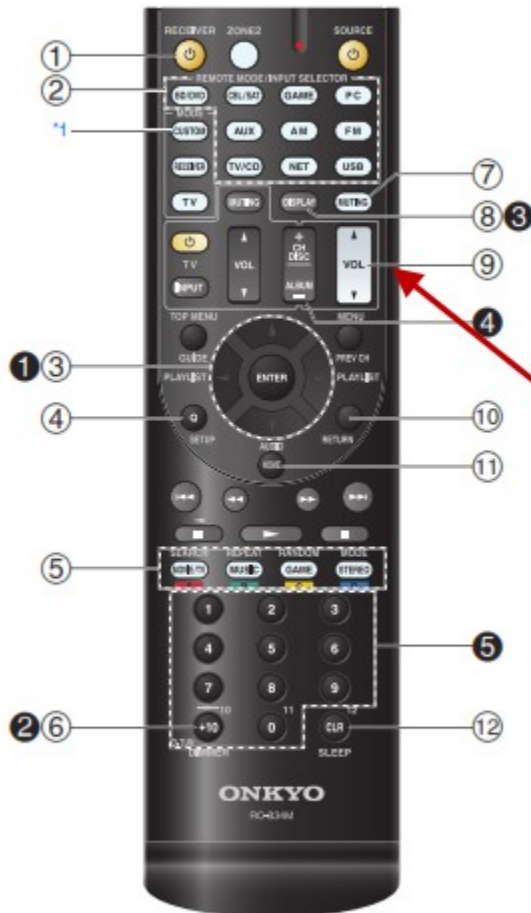

To control the AV receiver, press **RECEPTOR** to select Receiver mode.

You can also use the remote controller to control Onkyo Blu-ray Disc/DVD player, CD player, and other components.

See "Entering Remote Control Codes" for more details (→ [page 71](#)).

For detailed information, see the pages in parentheses.

- ① **RECEPTOR** button (20)
- ② **REMOTE MODE/INPUT SELECTOR** buttons (23)
- ③ **▲/▼/◀/▶** and **ENTER** buttons
- ④ **Q SETUP** button (45)
- ⑤ **Listening Mode** buttons (37)
- ⑥ **DIMMER** button (43)
- ⑦ **MUTING** button (44)
- ⑧ **DISPLAY** button (43)
- ⑨ **VOL ▲/▼** button (23)
- ⑩ **RETURN** button
- ⑪ **HOME** button (42)
- ⑫ **SLEEP** button (43)

#### ■ Controlling the tuner

To control the AV receiver's tuner, press **AM** or **FM** (or **RECEPTOR**).

- ① **▲/▼** buttons (31)
- ② **D.TUN** button (31)
- ③ **DISPLAY** button
- ④ **CH +/-** button (32)
- ⑤ **Number** buttons (31)

\*1 To control a component, you must first enter the remote control code.

See "Entering Remote Control Codes" for more details (→ [page 71](#)).

# Hitachi Projector CP-SX8350 - TA1, TA3

## Introduction

### Part names (continued)

#### Remote control

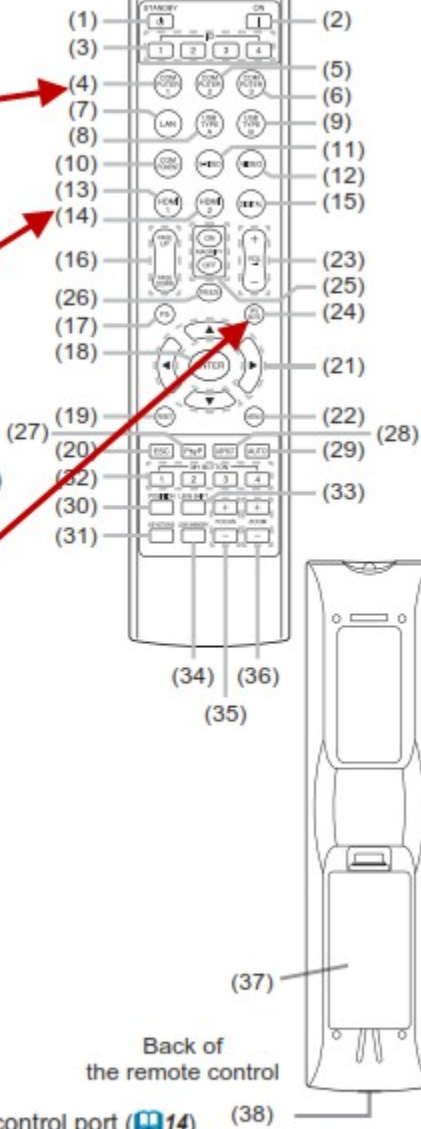
- 
- (1) **STANDBY** button (119)
- (2) **ON** button (119)
- (3) **ID - 1 / 2 / 3 / 4** buttons (17)
- (4) **COMPUTER 1** button (26)
- (5) **COMPUTER 2** button (26)
- (6) **COMPUTER 3** button \*
- (7) **LAN** button (26)
- (8) **USB TYPE A** button (26)
- (9) **USB TYPE B** button (26)
- (10) **COMPONENT** button (26)
- (11) **S-VIDEO** button (26)
- (12) **VIDEO** button (26)
- (13) **HDMI 1** button (26)
- (14) **HDMI 2** button (26)
- (15) **DIGITAL** button \*
- (16) **PAGE UP / PAGE DOWN** buttons (19, 96)
- (17) **F5** button (18, 19)
- (18) **ENTER** button (19, 22, 39)
- (19) **RESET** button (39)
- (20) **ESC** button (19, 39)
- (21) **▲/▼/◀/▶** cursor buttons
- (22) **MENU** button (39)
- (23) **VOL + / -** buttons (25)
- (24) **AV MUTE** button (25)
- (25) **MAGNIFY ON / OFF** buttons (35)
- (26) **FREEZE** button (36)
- (27) **PbyP** button ◦ (37)
- (28) **ASPECT** button (27)
- (29) **AUTO** button (31)
- (30) **POSITION** button (30, 31, 40)
- (31) **KEystone** button (32)
- (32) **MY BUTTON - 1, 2, 3, 4** buttons (68)
- (33) **LENS SHIFT** button (29)
- (34) **LENS MEMORY** button (30)
- (35) **FOCUS + / -** buttons (29)
- (36) **ZOOM + / -** buttons (29)
- (37) **Battery cover** (17)
- (38) **Wired remote control port** (14)

**NOTE** • Any button marked with "\*" is not supported on this projector (119).  
 • Any button marked with "◦" is available only for CP-WX8240A, CP-WX8255A, CP-WU8440 and CP-WU8450.  
 • Each time you press any button (except ID buttons), the ID button of current selected ID number will light (17).

## Hitachi CP-SX635 Projector – TA2

### Remote control

- (1) Laser pointer (13)  
It is a beam outlet.
- (2) LASER INDICATOR (13)
- (3) LASER button (13)
- (4) STANDBY/ON button (16)
- (5) VOLUME+/- buttons (17)
- (6) MUTE button (17)
- (7) VIDEO button (18)
- (8) RGB button (17)
- (9) SEARCH button (18)
- (10) AUTO button (19)
- (11) ASPECT button (18)
- (12) POSITION button (20)
- (13) KEYSTONE button (20)
- (14) MY SOURCE/DOC.CAMERA button (18)
- (15) MAGNIFY - ON/- OFF buttons (21)
- (16) FREEZE button (21)
- (17) BLANK button (22)
- (18) MY BUTTON - 1 button (46)
- (19) MY BUTTON - 2 button (46)
- (20) MENU button (23)
- (21) Lever switch (23) : acting 3 functions as below.  
Cursor button ▲ : to slide toward the side marked ▲.  
Cursor button ▼ : to slide toward the side marked ▼.  
ENTER button : to push down the center point.
- (22) Cursor buttons ◀/▶ (23)
- (23) RESET button (23)
- (24) ESC button (23)
- (25) Mouse left button (15)
- (26) Mouse right button (15)
- (27) PAGE UP button (15)
- (28) PAGE DOWN button (15)
- (29) Wired remote control port (15)
- (30) Battery cover (13)
- (31) Battery holder (13)
- (32) Frequency switch (14)

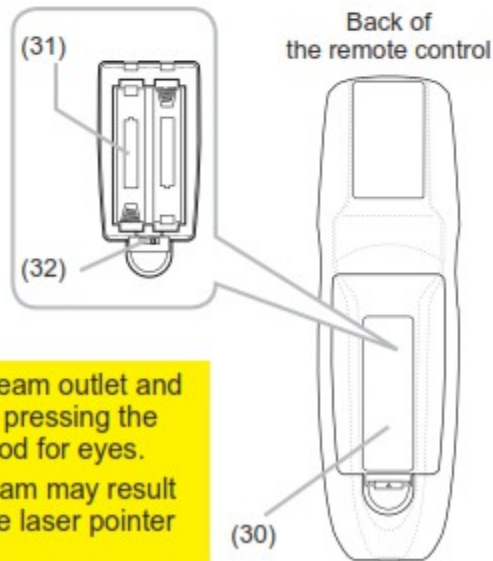
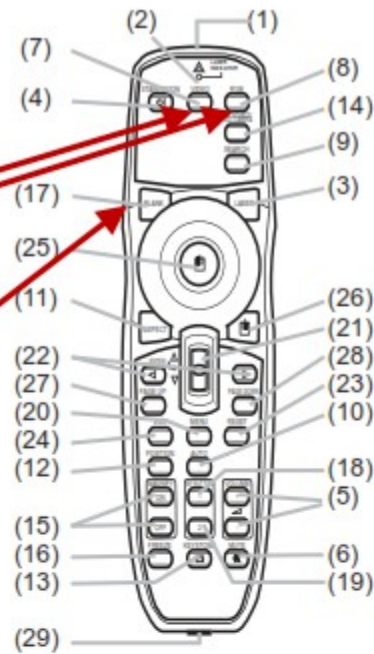



**⚠ WARNING** ▶ Do not look into the beam outlet and point the beam at people and pets while pressing the LASER button, since the beam is not good for eyes.

**⚠ CAUTION** ▶ Note that the laser beam may result in hazardous radiation exposure. Use the laser pointer only for pointing on the screen.

# Cottage Projector – Hitachi CP-DX250

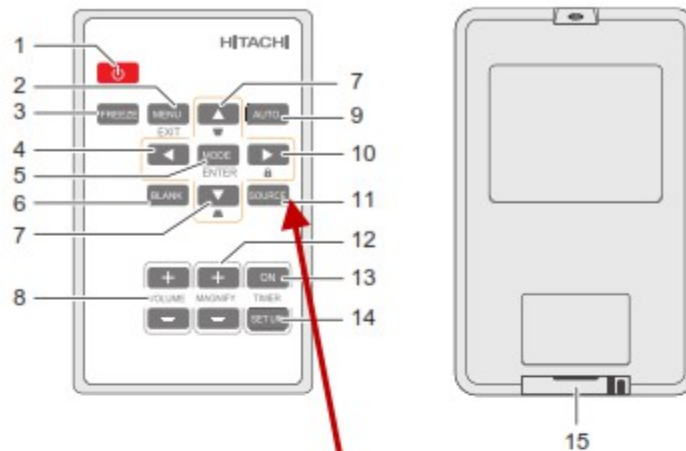
## Remote control



1.  Toggles the projector between standby mode and on.
2. **MENU/EXIT**  
Turns on the On-Screen Display (OSD) menu. Goes back to previous OSD menu, exits and saves menu settings.
3. **FREEZE**  
Freezes the projected image.
4. **◀Left**
5. **MODE/ENTER**  
Selects an available picture setup mode.
6. **BLANK**  
Used to hide the screen picture.
7. **Keystone/Arrow keys (▲▼Up, ▼▲Down)**  
Manually corrects distorted images resulting from an angled projection.
8. **VOLUME (+, -)**  
Adjusts the sound level.
9. **AUTO**  
Automatically determines the best picture timings for the displayed image.
10. **▶Right**  
Activates panel key lock.  
When the On-Screen Display (OSD) menu is activated, the #3, #4, and #9 keys are used as directional arrows to select the desired menu items and to make adjustments.
11. **SOURCE**  
Displays the source selection bar.
12. **MAGNIFY (+, -)**  
Magnifies or reduces the projected picture size.
13. **TIMER ON**  
Activates or displays an on-screen timer based on your own timer setting.
14. **TIMER SET UP**  
Enters presentation timer setting directly.
15. **Battery cover**



# Front Panel & Remote Controls

ENGLISH

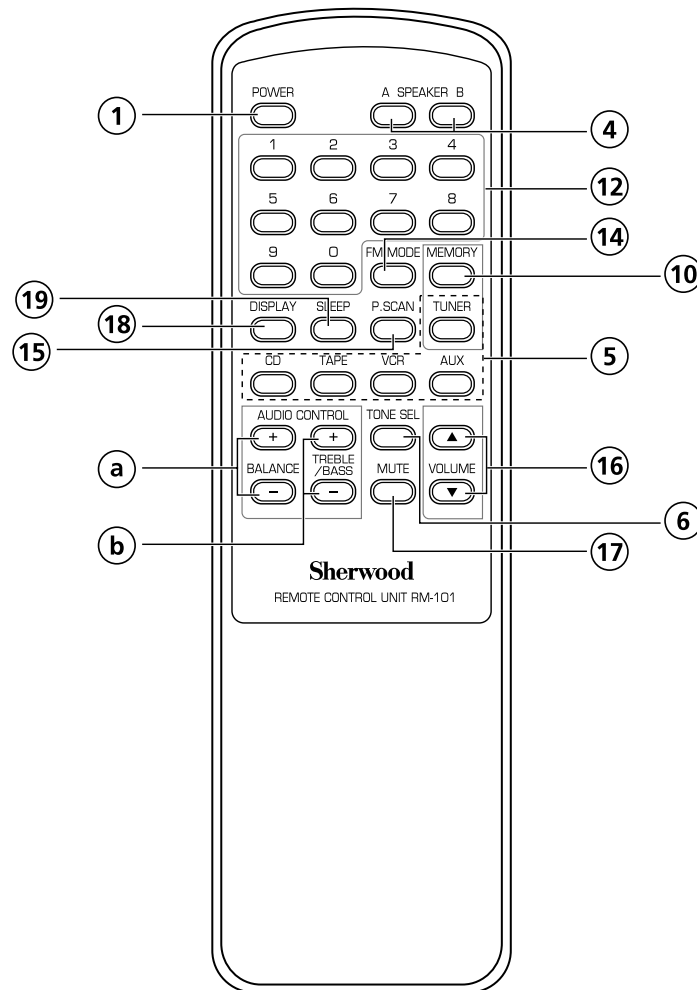
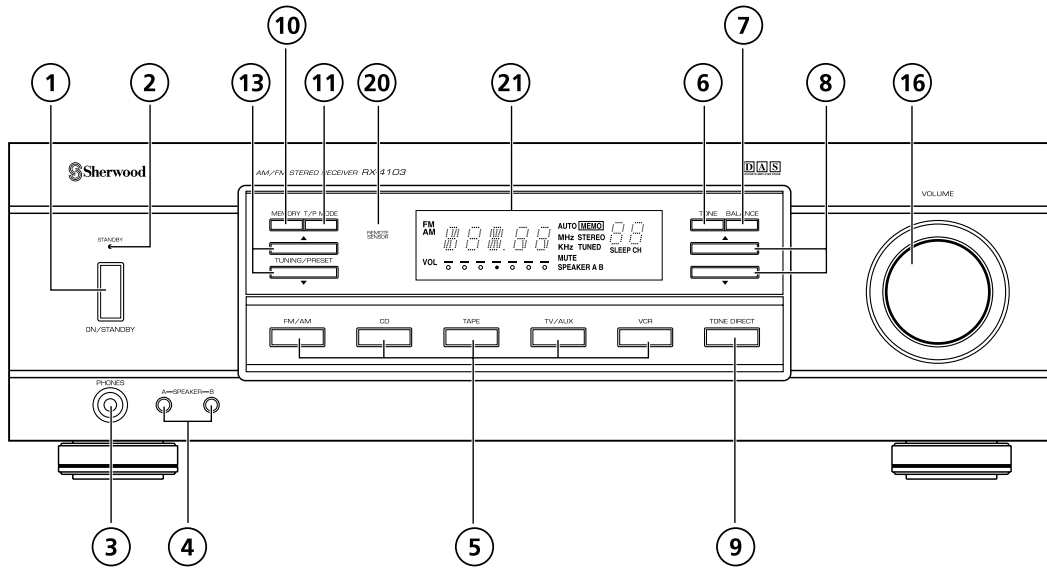

**① POWER BUTTON**

Press this button to turn the power on, then the STANDBY indicator goes off.  
Press again this button to turn the power off, then the STANDBY indicator lights up.

**② STANDBY INDICATOR****③ HEADPHONE JACK**

Stereo headphones with a standard 1/4 inch plug can be plugged into this jack for private listening.

**④ SPEAKER A, B SELECTOR BUTTONS**

These buttons allow you to select various combinations of speakers as follows:

- To drive A speakers, press only the SPEAKER A button (“SPEAKER A” lights up).
- To drive B speakers, press only the SPEAKER B button (“SPEAKER B” lights up).
- To drive both A and B speakers, press the SPEAKER A and B buttons (“SPEAKER A” and “B” light up).
- When using headphones for private listening, press these buttons to switch off the speaker A and B (“SPEAKER A” and “B” go off).

**⑤ INPUT SELECTOR BUTTONS**

Press the button to select the desired input source.

**⑥ TONE BUTTON**

When adjusting the tone (bass and treble), press this button to select the desired tone mode.

- Each time this button is pressed, the tone mode is changed to bass or treble.

**⑦ BALANCE BUTTON**

When adjusting the sound volume balance, press this button to enter the balance mode.

**⑧ BALANCE, TREBLE/BASS UP/DOWN (▲/▼, +/-) BUTTONS**

- At the balance mode, adjust the sound volume balance between left and right speakers with these buttons.
- When the BALANCE +/- buttons on the remote control are pressed, it enters the balance mode automatically without pressing the BALANCE button on the front panel.
- At the desired tone mode, adjust the tone as desired with these buttons.

**⑨ TONE DIRECT BUTTON**

Press this button to listen to a program source without the tone effect.

**⑩ MEMORY BUTTON**

Press this button to store preset stations.

**⑪ TUNING/PRESET MODE BUTTON**

Press this button to select the tuning mode or the preset mode.

**⑫ NUMERIC BUTTONS(0 ~ 9)**

Press these buttons to select or to store preset stations directly.

**⑬ TUNING/PRESET UP/DOWN(▲/▼) BUTTONS**

Press these buttons to tune in the desired stations.

**⑭ FM MODE BUTTON**

Press this button to select the desired FM mode.

- Each time this button is pressed, the FM mode is changed to the stereo mode or the mono mode.

**⑮ PRESET SCAN BUTTON**

Press this button to scan the stations in the preset sequence.

**⑯ VOLUME CONTROL KNOB, UP/DOWN(▲/▼) BUTTONS**

Adjust the volume to a comfortable listening level with this knob or these buttons.

**⑰ MUTE BUTTON**

Press this button to temporarily mute the sound.  
Press again to resume the previous sound level.

**⑱ DISPLAY BUTTON**

Press this button to select the brightness of unit’s display as desired.

- Each time this button is pressed, the brightness of unit’s display changes as follows:

→ ON → dim → OFF

**⑲ SLEEP BUTTON**

Press this button to activate the sleep timer for a specified period of time.

- Each time this button is pressed, the sleep time changes as follows:

→ 10 → 20 → 30 → 60 → 90 → OFF  
Unit : minutes

**⑳ REMOTE SENSOR**

This receives the signals from the remote control unit.

**㉑ FLUORESCENT DISPLAY**

For details, see the next page.

## Rear Panel

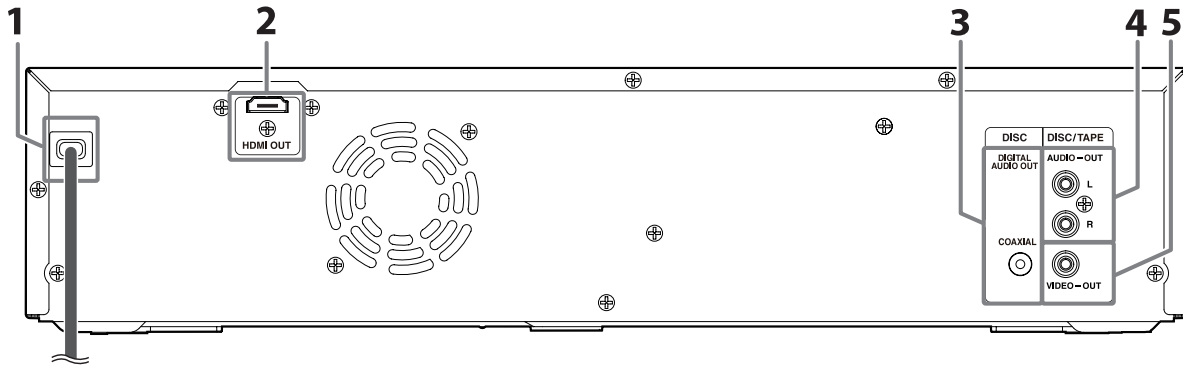

### 1. AC power cord

- Connect to a standard AC outlet to supply power to this unit.
- Unplug this cord from the AC outlet to completely turn off the unit.

### 2. HDMI OUT jack

- Use to connect a TV with an HDMI compatible port with an HDMI cable.

### 3. DIGITAL AUDIO OUT (COAXIAL) jack (DISC)

- Use to connect an AV receiver / amplifier, Dolby Digital / DTS decoder or another device with a digital audio coaxial input jack used with a digital audio RCA cable.

### 4. AUDIO-OUT jacks

- Use to connect a TV, an AV receiver / amplifier or other device with an RCA audio cable.

### 5. VIDEO-OUT jack

- Use to connect a TV, an AV receiver or other device with an RCA video cable.

### Caution

- Do not touch the inner pins of the jacks on the rear panel. Electrostatic discharge may cause permanent damage to the unit.

### Note

- This unit does not have the RF modulator.
- DIGITAL AUDIO OUT (COAXIAL) jack can only be used for DISC playback.
- This unit does not support fun-Link (HDMI CEC) functions.

## Remote Control

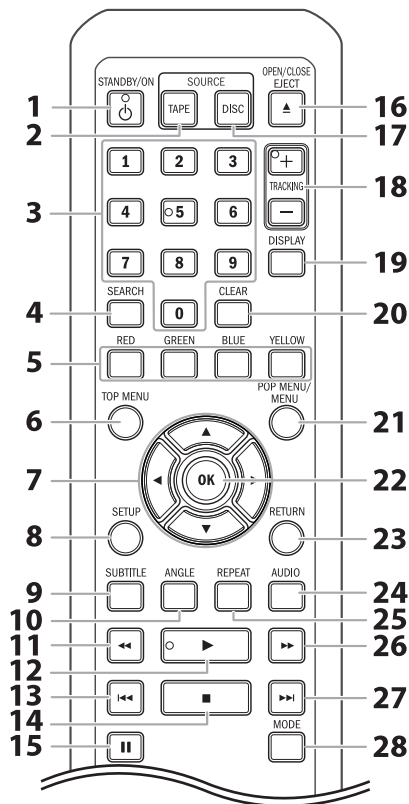

### 1. STANDBY/ON button

- Press to turn on the unit, or to turn the unit into the standby mode. (To completely turn off the unit, you must unplug the AC power cord.)

### 2. TAPE button

- Press to select the TAPE (VCP) output mode.

### 3. Number buttons (DISC)

- Press to enter the title, chapter, track or file number.
- Press to enter values in the input field.

### 4. SEARCH button

- Press to display the search menu.

### 5. RED / GREEN / BLUE / YELLOW button (DISC)

- Press to select items on some BD menus.
- When file list / thumbnail list is shown, press to switch between pages.

### 6. TOP MENU button (DISC)

- Press to display the top menu.

### 7. / / / buttons

- Press to select items or settings.

### 8. SETUP button

- Press to display the setup menu.

### 9. SUBTITLE button (DISC)

- Press to display the subtitle menu.

### 10. ANGLE button (DISC)

- Press to access various camera angles on the disc.
- Press to rotate the JPEG files clockwise by 90 degrees.



## 11. ◀◀ (reverse) button

### DISC mode:

- During playback, press to fast reverse the playback.

### TAPE mode:

- During playback, press to view the picture rapidly in reverse.
- Press to fast reverse the cassette tape in stop mode.

## 12. ▶ (play) button

- Press to start playback or resume playback.

## 13. ◀◀ (skip) button (DISC)

- During playback, press once to return to the beginning of the current title, chapter or track.
- During playback, press twice to return to the previous title, chapter or track.
- During the JPEG playback, press to return to the previous file.

## 14. ■ (stop) button

- Press to stop playback.

## 15. || (pause) button

- Press to pause playback.
- When playback is in pause mode, press repeatedly to forward the playback step by step.

## 16. OPEN/CLOSE EJECT ▲ button

### DISC mode:

- Press to open or close the disc tray.

### TAPE mode:

- Press to remove the cassette tape from the cassette compartment.

## 17. DISC button

- Press to select the DISC output mode.

## 18. TRACKING -/+ buttons (TAPE)

- Press to adjust the tracking manually.

## 19. DISPLAY button

### DISC mode:

- Press to display the on-screen display menu.

### TAPE mode:

- Press to display the current tape counter.

## 20. CLEAR button

### DISC mode:

- Press to clear the information once entered or to cancel the programming for audio CD, etc.

### TAPE mode:

- Press to reset the tape counter.

## 21. POP MENU/MENU button (DISC)

- Press to display the pop-up menu / disc menu.

## 22. OK button (DISC)

- Press to confirm or select menu items.

## 23. RETURN button (DISC)

- Press to return to the previously displayed menu screen.

## 24. AUDIO button

### DISC mode:

- Press to display the audio menu.

### TAPE mode:

- During the playing of a Hi-Fi video tape, press to change the audio out setting to Hi-Fi or mono.

## 25. REPEAT button

### DISC mode:

- Press to toggle between various repeat modes.

### TAPE mode:

- Press to set or release the auto repeat playback. In the auto repeat playback mode, tape is played to its end, the tape will rewind to the beginning and start playback itself.

## 26. ▶▶ (forward) button

### DISC mode:

- During playback, press to fast forward the playback.
- In pause mode, press to slow forward the playback.

### TAPE mode:

- During playback, press to view the picture rapidly in forward.
- Press to fast forward the cassette tape in stop mode.
- When playback is paused, press to view the cassette tape in slow motion.

## 27. ▶▶| (skip) button (DISC)

- During playback, press to skip to the next title, chapter, track or file.

## 28. MODE button (DISC)

- During BD, DVD or AVCHD playback, press to display the setting for the rapid playback and the picture adjustment.
- During BD, DVD, CD and AVCHD playback, press to display the setting for the virtual surround.
- During BD playback, press to turn the picture-in-picture feature on or off (only applicable to BD-video which supports the PIP function).
- During the JPEG playback, press to display menus for changing the visual effect for switching the image or changing the size of the image.
- In stop mode with BD inserted, press to display a menu for setting the BD audio mode.
- In stop mode with audio CD or JPEG files inserted, press to display menus for program and random playback.

### Note

- If you turn off this unit, [OPEN/CLOSE EJECT ▲] on the remote control is not available. Be sure to use [▲ OPEN/CLOSE] or [■ STOP/EJECT ▲] on the front panel.





# Remote Control

INTRODUCTION

- POWER**  
Turns DVD+VCR ON and OFF.
- DVD**  
Select the DVD+VCR function mode to DVD.
- VCR**  
Select the DVD+VCR function mode to VCR.
- INPUT**  
Selects the VCR deck's source (Tuner, LINE 1, or LINE 2).
- 0-9 numerical buttons**  
Selects numbered options in a menu.
- TV/VCR**  
To view channels selected by the VCR tuner or by the TV tuner.
- DISPLAY, CLK/CNT**  
Accesses On-Screen Display. Switches among the clock, tape counter and tape remaining modes on the display.
- SETUP, MENU**  
Accesses or removes DVD Setup menu and VCR menu.
- ◀▶▲▼ (left/right/up/down)**  
Selects menu options.
- CH/TRK(▲+▼)** : Selects VCR channels. Adjusts manually the tape's picture onscreen.
- ENTER**  
Confirms menu selections.
- DISC MENU**  
Accesses menu on a DVD disc.
- RETURN (↶)**  
Removes the menu.
- AUDIO**  
Selects an audio language (DVD).
- SUBTITLE**  
Selects a subtitle language.
- ANGLE**  
Selects a DVD camera angle, if available.
- ZOOM**  
Enlarges DVD video image.

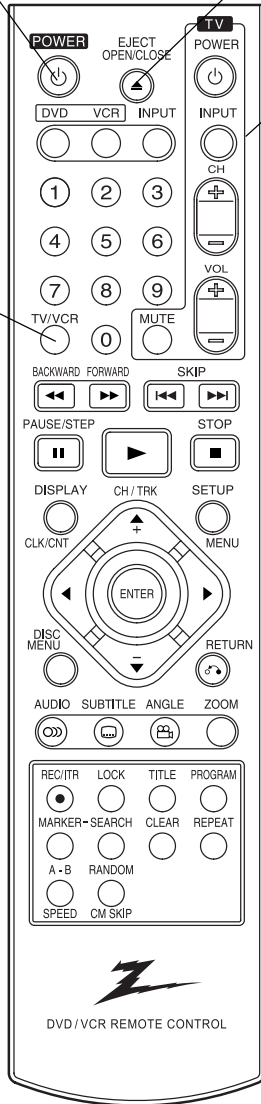

- EJECT, OPEN/CLOSE**
  - Opens and closes the disc tray.
  - Ejects the tape in the VCR deck.
- TV Control Buttons (See page 34)**
  - **POWER**: Switches TV ON and OFF.
  - **INPUT**: Selects the TV's source.
  - **CH +/-**: Selects TV's channel.
  - **VOL +/-**: Adjusts TV's volume.
  - **MUTE**: Turns on or off TV sound.
- BACKWARD / FORWARD (◀▶)**
  - DVD: Search backward or forward.
  - VCR: Rewinds/Advances the tape during the STOP mode, for fast reverse/forward picture search.
- SKIP (◀◀ / ▶▶)**  
Go to next chapter or track. Returns to beginning of current chapter or track or go to previous chapter or track.
- PAUSE/STEP (⏸)**  
Pause playback or recording. Press repeatedly for frame-by-frame playback.
- ▶ (PLAY)**  
Starts playback.
- STOP (■)**  
Stops playback or recording.
- REC/ITR (●)**  
Starts recording. Press repeatedly to set the recording time.
- LOCK**  
Locks/unlocks front panel buttons.
- TITLE**  
Displays the disc's Title menu, if available.
- PROGRAM**  
Accesses or removes Program menu.
- MARKER**  
Marks any point during playback.
- SEARCH**  
Displays Marker Search menu.
- CLEAR**  
Removes a mark on the Marker Search menu.
- REPEAT**  
Repeat chapter, track, title or all.
- A-B/SPEED**
  - Repeats sequence between two points (A and B).
  - Selects recording speed.
- RANDOM/CM SKIP**
  - Plays tracks in random order.
  - Fast forwards picture search through 30 seconds of recording.

## LOCK

The Lock feature disables the front panel buttons to prevent children from tampering with the DVD+VCR. Simply press LOCK on the remote control to toggle this feature on and off.



## Remote Control

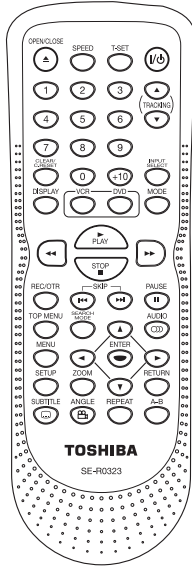

### Installing the Batteries for the Remote Control

Install two AA batteries (supplied) matching the polarity indicated inside battery compartment of the remote control.

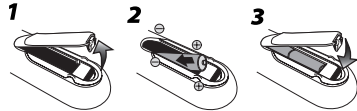

Keep in mind the following when using the remote control:

- Make sure that there are no obstacles between the remote control and the infrared sensor window on the unit.
- The maximum operable ranges from the unit are as follows.
  - **Line of sight:** approx. 23 feet (7m)
  - **Either side of center:** approx. 23 feet (7m) within 30°

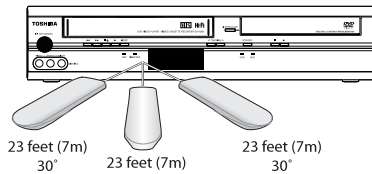

#### Note:

- Do not mix alkaline and manganese batteries.
- Do not mix old and new batteries.
- Always remove batteries from remote control if they are dead or if the remote control is not to be used for an extended period of time. This will prevent battery acid from leaking into the battery compartment.
- If you turn off this unit, [OPEN/CLOSE ▲] on the remote control is not available. Be sure to use [OPEN/CLOSE ▲] or [■/▲ (STOP/EJECT)] on the unit.

Media Button (Alphabetical order)	DVD mode		VCR mode
	DVD	CD JPEG	VHS
I/B	• To turn the unit on/off.	• To turn the unit on/off.	• To turn the unit on/off.
1-9	• To select chapter or title directly.	• To select track or file directly.	—
◀ ▶	• To search forward/backward through a disc. • To begin slow forward/reverse playback in the pause mode.	• To search forward/backward through a disc. (CD)	• To forward/backward a tape. • To begin slow forward playback in the pause mode.
A-B	• To repeat between your chosen point of A and B.	• To repeat between your chosen point of A and B. (CD)	—
ANGLE	• To select camera angles on a disc.	• To rotate a picture 90 degrees clockwise. (JPEG)	—
AUDIO	• To select audio languages on a disc.	• To select "STEREO", "L-ch" or "R-ch". (CD)	• To select "HIFI" or "MONO" mode during playback. (Hi-Fi tapes only)
MARKER	• To clear the markers. • To clear numbers entered incorrectly. • To cancel the point A for A-B repeat setting.	• To clear the markers. (CD) • To remove status number in program input. • To clear numbers entered incorrectly. • To cancel the point A for A-B repeat setting. (CD)	• To exit the VCR menu. • To reset the tape counter.
DISPLAY	• To display the current disc mode.	• To display the current disc mode.	• To display the current time, tape counter, "DISC", "L1" or "L2".
DVD	• To select DVD output mode. • To activate DVD mode.	• To select the DVD output mode. • To activate DVD mode.	—
ENTER	• To move the cursor and determine its position.	• To move the cursor and determine its position. • To skip files. (JPEG)	• To select an item on the VCR menu. • To advance to the next VCR menu. • To go back one step during clock and timer programming.
DISC	—	—	• To select input "DISC", "L1" or "L2".
MENU	• To call up the disc menu on a disc.	• To call up the file list. (JPEG)	—
MODE	• To set black level on/off. • To set virtual surround on/off.	• To program the playing order or play randomly. • To set virtual surround on/off. (CD) • To activate the Slide Show mode. (JPEG)	—
OPEN/CLOSE	• To open or close the disc tray.	• To open or close the disc tray.	• To eject the cassette tape from the cassette compartment.
PAUSE	• To pause disc playback. • To advance playback one frame at a time.	• To pause disc playback.	• To pause tape playback or recording. • To advance playback one frame at a time.
PLAY	• To begin disc playback.	• To begin disc playback.	• To begin tape playback.
REC/OTR	—	—	• To start recording or one-tough timer recording (OTR).
REPEAT	• To play back a chapter or title repeatedly.	• To play back a track or disc repeatedly. (CD) • To play back a file, folder or disc repeatedly. (JPEG)	• To select the repeat mode on/off.
RETURN	• To return to the previous operation in menu.	• To return to the previous operation in menu.	—
SEARCH	• To search chapter, title or time. • To set or search the markers.	• To search track. • To search time. (CD) • To set or search the markers. (CD)	• To call up the index or time search menu.
SETUP	• To call up the DVD setup menu.	• To call up the DVD setup menu.	• To call up the VCR menu.
SKIP	• To skip chapters or titles.	• To skip tracks or files.	—
SPEED	—	—	• To select the recording speed.
STOP	• To stop playback.	• To stop playback.	• To stop playback or recording.
SUBTITLE	• To select subtitles on a disc.	—	—
T-SET	—	—	• To put the VCR into standby mode for a timer recording.
TOP MENU	• To call up the top menu on a disc.	• To return to the top file of the highest hierarchy in the program and file list. (JPEG)	—
TRACKING	• To adjust the tracking manually during playback.	—	• To adjust the tracking manually during playback.
VCR	—	—	• To select the VCR output mode. • To activate VCR mode.
ZOOM	• To magnify part of a picture. (2x/4x)	• To magnify part of a picture. (2x) (JPEG)	—



## DVD Display Panel

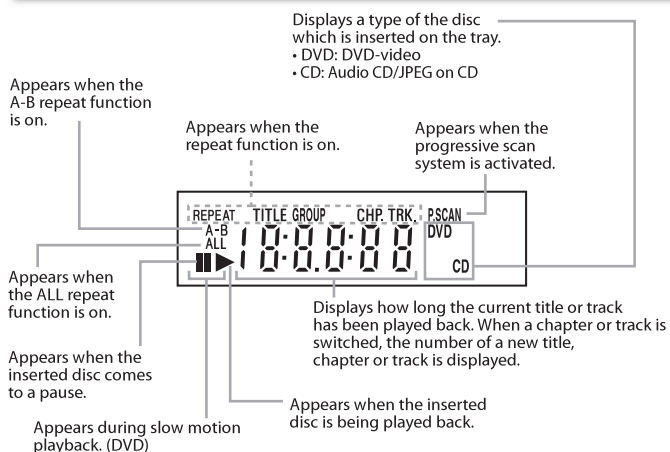

	No disc inserted or cannot read
	Tray open
	Tray closed
	Loading the Disc

## VCR Display Panel

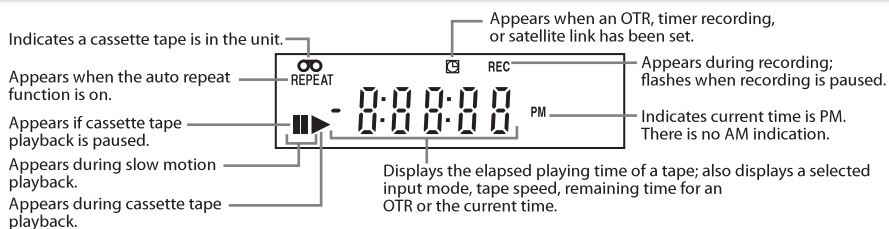

## Selecting DVD or VCR Operation

You must first select either DVD or VCR operation.

### VCR MODE

Press [VCR] on the remote control. (Verify that the VCR indicator is lit.)

### DVD MODE

Press [DVD] on the remote control. (Verify that the DVD indicator is lit.)

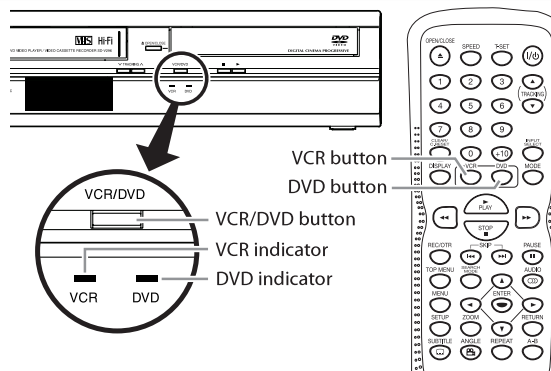

Precautions

Setup

VCR Functions

DVD Functions

Information

Español



### Confidence. Control. Credibility.

PRESENTATION PILOT PRO IS THE IDEAL WIRELESS PRESENTATION REMOTE TO USE WITH POWERPOINT AND KEYNOTE.



Pilot Pro features slide control, slide hide, laser pointing, complete mouse control and a USB receiver that stores inside. It's 50 feet of radio-frequency range provides freedom of motion for audience interaction during a presentation. Just plug in the USB receiver and go. There is no complicated set-up. This innovative remote ensures that control is at your fingertips wherever you stand in the room. With such a complete set of features, Educators and Corporate Professionals agree that Presentation Pilot Pro is key to good presenting.

INTERLINK ELECTRONICS

Corporate Office:  
546 Flynn Road  
Camarillo, CA 93012 USA  
Phone: (800) 340-1331  
Fax: (805) 484-8989  
www.interlinkelectronics.com

Japan Office:  
4F Shinoda Bldg., 1-10-7 Higashi Kanda  
Chiyoda-Ku, Tokyo 101-0031 Japan  
Phone: 03-3863-6493  
Fax: 03-3863-6442  
www.interlinkelec.co.jp

©2006 Interlink Electronics, Inc.  
P/N 94-72789 Rev. A  
RemotePoint, Interlink Electronics and the six dot logo are trademarks of Interlink Electronics, Inc.  
US and foreign patents pending.



#### REMOTE SPECIFICATIONS

- Range: Up to 50 feet (15m)
- Frequency: 2.4GHz
- Radio: 4 Channels
- One of 64,000 addresses
- Dimensions w/Receiver: 4.65"x2.04"x1.05" (118.1mm x 52mm x 26.7mm)
- Weight: 2.0 oz
- Power: CR2025 Coin Battery
- Battery Life: 6 months typical
- Laser: Class II Laser

#### RECEIVER SPECIFICATIONS

- Interface: USB
- Dimensions: 13/16" x 3 1/2" x 1/8" (21mm x 89mm x 11mm)
- Weight: Less than 2 ounces (60g)
- Power: 20 mA

#### SYSTEM REQUIREMENTS

- USB 1.1 or 2.0 interface
- Windows 2000, ME, XP Mac 8.x and up
- Microsoft PowerPoint or Apple Keynote

#### WARRANTY

- One Year, Limited Warranty
- Toll Free Customer Support

