

SAMSUNG

E-MANUAL

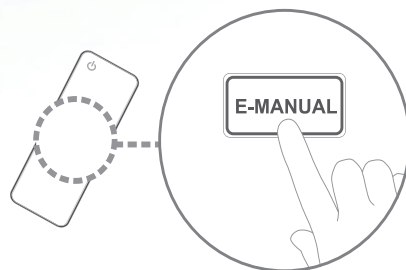

imagine the possibilities

Thank you for purchasing this Samsung product.
To receive more complete service, please register
your product at

www.samsung.com/register

Model _____ Serial No. _____

Contents

Channel Setting

- Using the Channel menu (Watch TV) 1
- Memorizing channels 17
- Other Features 21

Basic Features

- Picture Menu 23
- Sound Menu 40

Preference Features

- Network for LCD 550 series 49
- System Menu 81
- Support Menu 117

Advanced Features

- My Contents 130
- Anynet+(HDMI-CEC) 160
- AllShare™ for LCD 550 series 172

Other Information

- Troubleshooting 177
- Anti-theft Kensington Lock 195
- License 197

❑ Using the Channel menu (Watch TV)

Press the **CONTENT** button to select **Watch TV**, and then select the desired menu item. Choose from **Schedule Manager**, **Channel List**, and **Channel Manager**.

■ Schedule Manager

👉 **CONTENT** → **Watch TV** → **Schedule Manager** → **ENTER** 🏠

Select the Schedule menu item to access the **Timer Viewing** function. **Timer Viewing** let you display the channel you want at the time of your choice.









Using Timer Viewing

You can set the TV to display a desired channel automatically on a day and at a time of your choice.

 You must set the current time first using the **Time** → **Clock** function in the **System** menu to use this function.

To use **Timer Viewing**, follow these steps:

1. Press the **ENTER**  button on the **Schedule Manager** screen.
2. Press the **ENTER**  button to add a scheduled viewing.
3. Press the  /  /  /  buttons to set **Antenna**, **Channel**, **Repeat**, **Date**, and **Start Time**.
 - **Antenna**: Select **Air** or **Cable**.
 - **Channel**: Select the desired channel.

- **Repeat:** Select **Once**, **Manual**, **Sat~Sun**, **Mon~Fri** or **Everyday**. If you select **Manual**, you can set the day you want.

 A check (✓) mark indicates a day you selected.



- **Date:** You can set a desired date.

 Date is available only when you select **Once** in **Repeat**.

- **Start Time:** You can set the start time you want.

 If you want to edit or cancel a scheduled viewing, select the scheduled viewing on the **Schedule List**, and then select **Edit** or **Cancel Schedules**.

■ Channel List

 **CONTENT** → **Watch TV** → **Channel List** → **ENTER** 

The **Channel List** contains the channels your TV displays (added channels) when you press the Channel button on your remote control. On the **Channel List**, you can view **Added Channels**, channel information, **Favorites**, and manage channels.

 When you press the **CH LIST** button on the remote control, the **Channel List** screen is displayed at once.

- **Added Channels**: Show all added (memorized) channels.
- **Favorites 1-5**: Show all favorite channels, arranged in up to five groups. Each group has a separate screen.



 The TV displays **Favorites** only if you have added favorites using **Add to Favorites**.

 If you want to view the list of favorite channels quickly, press the **CH LIST** button, and then press the **▶ (CH Mode)** button to display **Favorites 1-5**. If you have favorites in more than one Favorite Group, press the **▶ (CH Mode)** to view the other groups. Press the **◀ (CH Mode)** button to return to the **Added Channels**.

 Using the colored and function buttons with the **Channel List**.

- **A** Red (**Antenna**): Switches the mode and display between **Air** or **Cable**.
- **C** Yellow (**Program View / Channel View**):

For digital channels, switches the display between **Program View** and **Channel View**. When you select a digital channel in **Channel View**, press once to display a list of programs on that channel. Press again to re-display the **Added Channels**.

- ◀▶ (**CH Mode / Channel**): Toggles between the **Favorites** list (if you have added favorites using **Add to Favorites**) and the **Added Channels**.
 - ◻ When you press the **C** (**Program View**) button, you can move to other channels using ◀▶(**Channel**) button.
- ◻◀ (**Watch / Information**): Press to watch the channel you selected. Displays details of the selected program.
- ⬆ (**Page**): Scrolls the **Channel List** to the next or previous page.





Channel Status Display Icons

Icon	Description
A	An analog channel.
Ⓛ	A reserved program.

How to use Timer Viewing in Channel List (digital channels only)

You can use **Timer Viewing** in **Channel List** to schedule a digital channel program for viewing. The TV will turn on and display the digital channel program when the program begins.



To schedule a digital program, follow these steps:

1. Press the **CH LIST** button, then select a desired digital channel.
 2. Press the  (**Program View**) button. The Program List for that channel appears.
 3. Press the ▲ / ▼ buttons to select the desired program, and then press the **ENTER**  or **INFO** button.
 4. Select **Timer Viewing**, and then press the **ENTER**  button.
-  If you want to cancel **Timer Viewing**, follow Steps 1 through 3, and then select **Cancel Schedules**.

Channel Manager

 **CONTENT** → **Watch TV** → **Channel Manager** → **ENTER** 

Using **Channel Manager**, you can add, edit, or delete Added and Favorite channels. You can also edit channel names - for analog channels only.

- () **Added Ch.:** Show all added channels.
- () **All Channels:** Show all currently available channels. Includes channels that have not been added.
- () **Favorites 1-5:** Show favorite channels, arranged in up to five groups. Each group has a separate screen.





Using the colored buttons with **Channel Manager**

- **A** Red (**Antenna**): Switches between **Air** and **Cable**.
- **D** Blue (**Sorting**): Sorts the channel list by channel number or by name.







Using the Arrow buttons with **Channel Manager**

1. Highlight a channel in the first column on the left, and then press the Left arrow button. The **Channel Manager** sub-menu appears.
2. Use the Up or Down arrow buttons to select **Added Ch.**, **All Channels** or **Favorite 1** through **5**, and then press **ENTER**  or the Right arrow button. The cursor enters the screen you selected.







If you have no favorites in a Favorite Group, the cursor will not enter that screen.

Channel Status Display Icons

Icon	Description
	An analog channel.
	A selected channel.
	A favorite channel.
	Displays the Channel Manager option menu.

Channel Manager Option Menu

Manage channels using the **Channel Manager** menu options (**Watch**, **Add to Favorites** / **Edit Favorites**, **Channel Name Edit**, **Add** / **Delete**, **Deselect All**, **Select All**). The Option menu items that appear may differ depending on the channel status and type.





1. Use the arrow buttons to select a channel, and then press the  **Tools** button. A check appears next to the channel.
 -  You can select more than one channel by highlighting each channel with the cursor, and then pressing **ENTER** .
2. Press the **TOOLS** button on your remote control.
3. Select an option, and then press **ENTER**  to activate the option or change its settings.
 -  Exceptions: Select All. See the end of the **Channel Manager** section for information.

Options





- **Watch**: Watch the channel you selected. Appears only if you selected a channel you are not currently watching. To use, select **Watch** on the Option menu, and then press **ENTER** .

- **Add to Favorites / Edit Favorites:** **Add to Favorites** appears if the channel you selected is not already a favorite. **Edit Favorites** appears if the channel you selected is already a favorite.







Using Add to Favorite to add a channel to the Favorites List:

1. Select **Add to Favorites**, and then press the **ENTER**  button. The **Add to Favorites** screen appears.
2. The **Add to Favorites** screen has five groups, **Favorites 1**, **Favorites 2**, etc. You can add a favorite channel to any one of the groups. Select a group using the up and down arrows on your remote control, and then press **ENTER** .
3. Select **OK**, press **ENTER** , and then press **ENTER**  again.

Using Edit Favorites to delete a channel from the Favorites List:



1. Select **Edit Favorites**, and then press the **ENTER**  button. The **Edit Favorite** screen appears.
2. The Favorite Group you assigned to that channel is checked. Select the group, and then press **ENTER** . The check disappears.
3. Select **OK**, press **ENTER** , and then press **ENTER**  again.

Using Edit Favorite to move a channel from one Favorite Group to another:





- 
1. Select **Edit Favorites**, and then press the **ENTER**  button. The **Edit Favorite** screen appears. 
 2. The Favorite Group you assigned to that channel is checked. Select the group, and then press **ENTER** . The check disappears.
 3. Use the Up or Down arrow key to highlight a different group, and then press **ENTER** . A check appears by the group's name.
 4. Select **OK**, press **ENTER** , and then press **ENTER**  again.

- **Channel Name Edit** (analog channels only): Assign a name of up to five characters to a channel. For example, Hist, Food, Golf, etc. This makes it easier to find and select the channel.
- **Add / Delete**: Add a channel or delete a channel from the channel list. When you use the channel button on your remote control to change channels, your TV only displays the channels on the channel list.

Deleting a Channel from the Channel List:



1. Select **Delete**, and then press the **ENTER**  button. The Delete pop-up appears.
2. Select **OK** on the pop-up, press **ENTER** , and then press **ENTER**  again.

Adding a Channel to the Channel List:

1. Select a deleted channel on the **All Channels** list, and then press the **ENTER**  button.
 Deleted channels are grayed out.
2. Press the **TOOLS** button on your remote control. The Options menu appears.
3. Select **Add**, press **ENTER** , and then press **ENTER**  again.

NOTE

- Your TV will display all channels, including channels you deleted from the channel list, on the **All Channels** list.
- A gray-colored channel on the **All Channels** list indicates the channel has been deleted from the channel list.

- **Add** only appears if you have selected a deleted channel on the **All Channels** list.
- **Delete** only appears if you have selected an added channel on the **Added Ch.** or **All Channels** list.
- **Deselect All**: Deselect all the selected channels.
 -  **Deselect All** appears only when you have selected one or more channels.
- **Select All**: Select all the channels in the channel list. To use, choose **Select All** in the Options menu, and then press **ENTER** . All channels are selected and a check appears by each channel. You can then apply one of the other options on the Options menu to all the selected channels.



❏ Memorizing channels

 MENU  → Channel → ENTER 

Your TV memorizes channels and adds the memorized channels to the **Channel List** with the **Auto Program** function. Before your TV can memorize channels, you must specify the signal source, either **Air** or **Cable**. If you select cable, when you start **Auto Program**, you must also specify the cable system type, **STD**, **HRC**, or **IRC**. If you don't know your cable system type, contact your local cable company for the information. Most cable companies use **STD**.

■ Antenna (Air / Cable) **TOOLS**

To begin the memorizing procedure, follow these steps:









1. Push **MENU**  → **Channel** → **ENTER**  on your remote control.
2. Select **Antenna**, and then press **ENTER** .
3. Select the source of your TV signal, **Air** or **Cable**. Go to the next section, **Auto Program**.



 Selecting **Air** or **Cable** also changes the actual signal input from **Air** to **Cable** or **Cable** to **Air**. Outside the menu, you can do the same thing by pressing the **TOOLS** button on your remote control. On the **Tools** menu, select **Switch to Air** or **Switch to Cable**.

■ Auto Program



Scans for channels automatically and stores them in the TV's memory.

To start **Auto Program**, follow these steps:

1. Push **MENU**  → **Channel** → **ENTER**  on your remote control.
2. Select **Auto Program**, and then press **ENTER** .
3. Select **Air** or **Cable** or both by highlighting and then pressing **ENTER** .
 If you selected **Air** or **Cable** or both on the Antenna screen, your choice will already be selected.
4. Select **Search** or **Next**, and then press **ENTER** .
5. If you selected **Cable**, the Cable System screen appears. Select **Digital Cable System**, and then press **ENTER** .
-  If you selected **Air** only, **Auto Program** starts.

6. Select **STD**, **HRC**, or **IRC**, and then press **ENTER** .
 7. Repeat for **Analog Cable System**.
 8. Select **Search** or **Next**, and then press **ENTER** . **Auto Program** starts.
-  After all the available channels are stored, **Auto Program** removes scrambled channels. When done, the **Auto Program** menu then reappears. This process can take up to 30 minutes

How to Stop Auto Programming

1. Press the **ENTER**  button.
2. A message will ask **Stop Auto Program?** Select **Yes** by pressing the ◀ or ▶ button.
3. Press the **ENTER**  button.



❑ Other Features

 MENU  → Channel → ENTER 

■ Clear Scrambled Channel

This function filters out scrambled channels after **Auto Program** is completed. This process may take up to 20~30 minutes.

How to Stop the Clear Scrambled Channels Function

1. Press the **ENTER**  button to select **Stop**.
2. Press the  button to select **Yes**.
3. Press the **ENTER**  button.

 This function is only available in **Cable** mode.

■ Fine Tune

(analog channels only)

If the reception is clear, you do not have to fine tune the channel, as this is done automatically during the search and store operation. If the signal is weak or distorted, fine tune the channel manually.

- Select **Fine Tune** in the **Channel** menu.
- 📖 Fine tuned channels that have been saved are marked with an asterisk “*” on the right-hand side of the channel number in the channel banner.
- 📖 To reset the fine-tuning, select **Reset**.

❑ Changing the Preset Picture Mode

 MENU  → **Picture** → **Picture Mode** → ENTER 



■ **Picture Mode**

Picture modes apply preset adjustments to the picture. Select a mode using the up and down arrow keys, and then press **ENTER** .



 When connecting a PC, you can only select **Entertain** and **Standard**.

- **Dynamic**: Suitable for a bright room.
- **Standard**: Suitable for a normal environment.
- **Natural** **for LCD 550 series**: For a display that is comfortable to the eye.
- **Movie**: Suitable for watching movies in a dark room.
- **Entertain**: Suitable for watching movies and games.

□ Adjusting picture settings

 MENU  → **Picture** → **Backlight** → ENTER 

■ **Backlight / Contrast / Brightness / Sharpness / Color / Tint (G/R)**



Your television has several options for adjusting picture quality. Select an option using the up and down arrow keys, and then press **ENTER** . Use the arrow keys to adjust the option value or select an option setting. When done, press **ENTER** .

NOTE

- When you make changes to **Backlight, Contrast, Brightness, Sharpness, Color** or **Tint (G/R)**, the OSD will be adjusted accordingly.
- When connecting a PC, you can only make changes to **Backlight, Contrast, Brightness**, and **Sharpness**.
- You can adjust and store settings for each external device connected to the TV.
- Lowering picture brightness reduces power consumption.

■ Screen Adjustment

 MENU  → **Picture** → **Screen Adjustment** → ENTER 

Screen Adjustment provides various picture size and aspect ratio options. Select an option using the up and down arrow keys, and then press **ENTER** . Use the arrow keys to select an option in the sub-menu, and then press **ENTER** .

- **Picture Size:** If you have a cable box or satellite receiver, it may have its own set of screen sizes as well. However, we highly recommend you use your TV's 16:9 mode most of the time.

16:9: Sets the picture to 16:9 wide screen mode.

Zoom1: Magnifies the picture moderately. Cuts off the top and sides.

Zoom2: Magnifies the picture more than **Zoom1**.

Wide Fit: Enlarges the aspect ratio of the picture so it fits the entire screen.

4:3: Sets the picture to **4:3** mode. For analog TV programs.

 Do not set your TV to **4:3** format for a long time. The borders displayed on the left and right, or top and bottom of the screen may cause image retention (screen burn) which is not covered by the warranty.

Screen Fit: When your TV inputs HDMI (720p / 1080i / 1080p) or Component (1080i / 1080p) signals, displays the full image without any cut-off.

Smart View1 **for LCD 550 series**: Reduces original screen size by 50%.



Smart View2 **for LCD 550 series**: Reduces original screen size by 25%.



 NOTE

- **Smart View1** is enabled only in HDMI mode.
- **Smart View2** is enabled only in DTV and HDMI modes.
- The picture size can vary depending on the input resolution when you play content using **Videos** in **My Contents**.



- **Position**: Adjusts the picture position. **Position** is only available if **Picture size** is set to **Zoom1**, **Zoom2**, **Wide Fit**, or **Screen fit**.



 To use the **Position** function after selecting **Zoom1**, **Zoom2** or **Wide Fit**, follow these steps:



1. Select the **Position**, and then press the **ENTER**  button.
2. Select the **Position** button, and then press **ENTER** 
3. Press the **▲** or **▼** button to move the picture up or down.
4. Press the **ENTER**  button.

 If you want to reset the pictures to its original position, select **Reset** in the **Position** screen, and then press **ENTER** . The picture will be reset to its default position.

 To use the **Position** function after selecting **Screen Fit** when connected to an HDMI (1080i/1080p) or Component (1080i/1080p) source, follow these steps:

1. Select the **Position**, and then press the **ENTER**  button.
2. Select the **Position** button, and then press **ENTER** .
3. Press the **▲**, **▼**, **◀** or **▶** button to move the picture.
4. Press the **ENTER**  button.

 If you want to reset the pictures to its original position, select **Reset** in the **Position** screen, and then press **ENTER** . The picture will be reset to its default position.

-  HD (High Definition): 16:9 - 1080i/1080p (1920x1080), 720p (1280x720)
-  You can adjust and store settings for each external device you have connected to an input on the TV.
-  Picture Sizes available by Input Source:

Input Source	Picture Size
ATV, AV	16:9, Zoom1, Zoom2, 4:3
Component (480i, 480p, 576i, 576p)	16:9, Zoom1, Zoom2, 4:3
DTV(720p, 1080i, 1080p)	16:9, Wide Fit, 4:3, Screen Fit, Smart View2
Component (720p, 1080i, 1080p)	16:9, Wide Fit, 4:3, Screen Fit
HDMI (720p, 1080i, 1080p)	16:9, Wide Fit, 4:3, Screen Fit, Smart View1, Smart View2
PC	16:9, 4:3

- **PC Screen Adjustment**

 Available in **PC** mode only.

Coarse / Fine: Removes or reduces picture noise. If the noise is not removed by Fine-tuning alone, use the **Coarse** function to adjust the frequency as best as possible and Fine-tune again. After the noise has been reduced, re-adjust the picture so that it is aligned to the center of screen.

Position: To adjust the PC's screen position if it is not centered or does not fit the TV screen. Press the ▲ or ▼ button to adjust the Vertical Position. Press the ◀ or ▶ button to adjust the Horizontal Position.

Image Reset: Resets the image to the default settings.

■ Auto Adjustment **TOOLS**

 **MENU**  → **Picture** → **Auto Adjustment** → **ENTER** 

Automatically adjusts the picture's frequency, position, and fine tunes settings in the **PC** mode.

 Available in **PC** mode only.

 Not available if you connect your PC with an HDMI to DVI cable.

Using Your TV as a Computer (PC) Display

◀ **Entering the Video Settings (Based on Windows XP)** ▶

For your TV to work properly as a computer display, you must enter the correct video settings into your PC.

 Depending on your version of Windows and your video card, the procedure on your PC will probably differ slightly from the procedure presented here. However, the same basic information will apply in most cases. (If not, contact your computer manufacturer or Samsung Dealer.)



1. On your PC, click “Control Panel” on the Windows start menu.
2. Click “Appearance and Themes” in the “Control Panel” window. A display dialog-box appears.
3. Click “Display”. Another display dialog box appears.
4. Click the “Settings” tab on the display dialog-box.
 - On the Settings tab, set the correct resolution.
 - If a vertical-frequency option exists on your display settings dialog box, select ‘60’ or ‘60 Hz’. Otherwise, just click ‘OK’ and exit the dialog box.

❑ Changing the Picture Options

■ Advanced Settings

 MENU  → **Picture** → **Advanced Settings** → ENTER 

Advance Settings are available in the **Standard** and **Movie** modes. When connecting a PC, you can only make changes to **Gamma** and **White Balance**. They are not available when you are watching a digital channel.

To use, select an option using the up and down arrow keys, and then press **ENTER** . Use the arrow keys to change a value or setting, and then press **ENTER** .

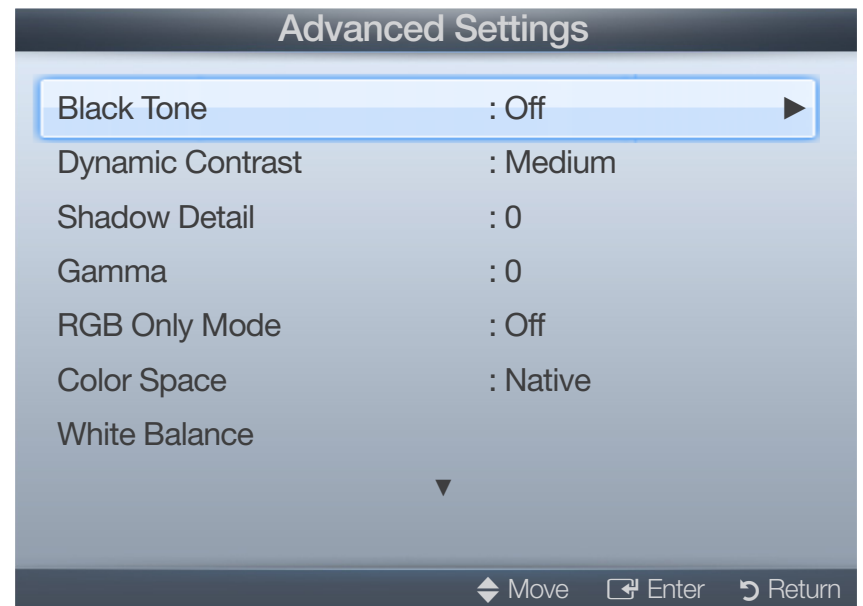

- **Black Tone (Off / Dark / Darker / Darkest)**: Select the black level to adjust the screen depth.
- **Dynamic Contrast (Off / Low / Medium / High)**: Adjusts the screen contrast.
- **Shadow Detail**: Increases the brightness of dark images.
- **Gamma**: Adjusts the primary color intensity.
- **RGB Only Mode (Off / Red / Green / Blue)**: Displays the Red, Green and Blue color for making fine adjustments to hue and saturation.



- **Color Space (Auto / Native):** Adjusts the range of colors (the color gamut) available to create images.
- **White Balance:** Adjusts the color temperature for a more natural picture.
R-Offset / G-Offset / B-Offset: Adjusts each color's (red, green, blue) darkness.
R-Gain / G-Gain / B-Gain: Adjusts each color's (red, green, blue) brightness.
Reset: Resets the **White Balance** to its default settings.
- **Flesh Tone:** Emphasizes pink "Flesh Tone".
- **Edge Enhancement (Off / On):** Emphasizes object boundaries.
- **Motion Lighting (Off / On):** Reduces power consumption by reducing screen brightness when the picture on the screen is motionless.

Picture Options

 **MENU**  → **Picture** → **Picture Options** → **ENTER** 

Select an option using the up and down arrow keys, and then press **ENTER** .
Use the arrow keys to change the setting, and then press **ENTER** .

 When connecting a PC, you can only make changes to **Color Tone**.

- **Color Tone (Cool / Standard / Warm1 / Warm2)**

 **Warm1** or **Warm2** will be deactivated when the picture mode is **Dynamic**.

 You can adjust and store settings for each external device connected to an input on the TV.

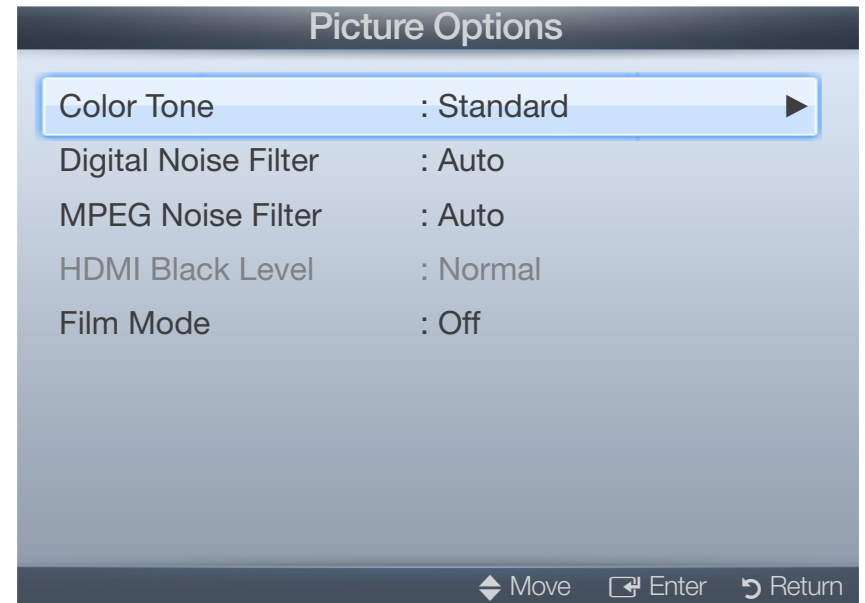

- **Digital Noise Filter (Off / Low / Medium / High / Auto / Auto Visualization):** If the broadcast signal received by your TV is weak, you can activate the **Digital Noise Filter** feature to reduce any static and ghosting that may appear on the screen.

 When the signal is weak, try each option until the TV displays best picture.

Auto Visualization: When changing analog channels, displays signal strength.

 Only available for analog channels.

 When the bar is green, you are receiving the best possible signal.

- **MPEG Noise Filter (Off / Low / Medium / High / Auto):** Reduces MPEG noise to provide improved picture quality.

- **HDMI Black Level (Low / Normal)**: Lets you select the black level on the screen to adjust the screen depth.
 - ☞ Available only in **HDMI** mode (RGB signals).
- **Film Mode (Off / Auto1 / Auto2)**: Sets the TV so that it senses and then processes film signals from all sources automatically and adjusts the picture for optimum quality.
 - ☞ Available in ATV, AV, COMPONENT (480i / 1080i) and HDMI (1080i).
 - ☞ If the screen does not seem natural, change its option to **Off / Auto1 / Auto2** in **Film Mode**.

■ **Reset Picture (OK / Cancel)**

Resets your current picture mode to its default settings.



❑ Changing the Preset Sound Modes

 MENU  → **Sound** → **Sound Mode** → ENTER 

■ **Sound Mode**

Use the up and down arrow keys to select an option, and then press **ENTER** .

- **Standard**: Selects the normal sound mode.
- **Music**: Emphasizes music over voices.
- **Movie**: Provides the best sound for movies.
- **Clear Voice**: Emphasizes voices over other sounds.
- **Amplify**: Increase the intensity of high-frequency sounds to allow a better listening experience for the hearing impaired.

□ Sound Settings

 MENU  → Sound → Sound Effect → ENTER 

■ Sound Effect

(standard sound mode only)

Use the up and down arrow keys to select an option, and then press **ENTER** .

- **SRS TruSurround HD (Off / On)**

This function provides a virtual 5.1 channel surround sound experience through a pair of speakers or headphones using HRTF (Head Related Transfer Function) technology.

- **SRS TruDialog (Off / On)**

This function allows you to increase the intensity of a voice over background music or sound effects so that dialog can be heard more clearly.

- **Equalizer**

Use Equalizer to customize sound setting for each speaker.

Balance L/R: Adjusts the balance between the right and left speaker.

100Hz / 300Hz / 1kHz / 3kHz / 10kHz (Bandwidth Adjustment): Adjusts the volume level of specific bandwidth frequencies.

Reset: Resets the equalizer to its default settings.



□ Adjusting Sound Settings

■ Broadcast Audio Options

- Preferred Language

(digital channels only)

Use the up and down arrow keys to select a language, and then press **ENTER** .

Digital-TV broadcasts can simultaneously transmit many audio tracks (for example, simultaneous translations of the program into foreign languages).

 You can only select a language from among the ones being broadcasted.

- **Multi-Track Sound (MTS)** 

(analog channels only)

Select an option using the up and down arrow keys, and then press **ENTER** .

Mono: Choose for channels that are broadcasting in mono or if you are having difficulty receiving a stereo signal.



Stereo: Choose for channels that are broadcasting in stereo.

SAP: Choose to listen to the Separate Audio Program, which is usually a foreign-language translation.

 Depending on the program being broadcast, you can listen to **Mono**, **Stereo** or **SAP**.

■ SPDIF Output



The SPDIF (Sony Philips Digital InterFace) outputs an uncompressed digital audio signal when you connect the digital audio jack on the back of the TV to a digital audio in jack on a receiver or home theater.

- **Audio Format:** You can select the Digital Audio output (SPDIF) format. The available Digital Audio output (SPDIF) format may differ depending on the input source.
 -  By connecting the TV to a receiver or home theater with **Dolby Digital** and 5.1ch speakers and selecting **Dolby Digital**, you can maximize your interactive 3D sound experience.
- **Audio Delay:** Lets you correct timing mismatches between the audio track and the video when you are watching the TV and listening to digital audio output from the TV through an external device such as an AV receiver. When you select **Audio Delay**, a slider appears. Use the left and right arrow buttons to adjust the slider. Press **ENTER**  when done (0ms ~ 250ms).

■ Speaker Settings

- **Speaker Select (External Speaker / TV Speaker)**

If you are listening to the sound track of a broadcast or movie through an external receiver, you may hear a sound echo caused by the difference in decoding speed between the TV's speakers and the speakers attached to your audio receiver. If this occurs, set the TV to **External Speaker**.

-  When you set **Speaker Select** to **External Speaker** the TV's speakers are turned off. You will hear sound through the external speakers only. When you set **Speaker Select** to **TV Speaker** both the TV's speakers and the external speakers are on. You will hear sound through both.
-  When **Speaker Select** is set to **External Speaker**, the **VOLUME** and **MUTE** buttons will not operate and the sound settings will be limited.
-  If there is no video signal, both the TV's speakers and the external speakers will be mute.



- **Auto Volume (Off / Normal / Night)**

Normal equalizes the volume level on each channel, so that when you change channels, the volume level is the same.

Night equalizes and decrease the volume level on each channel, so each channel is quieter. **Night** is useful at night, when you may want to keep the volume low.

 To use the volume control on the source device connected to the TV, set **Auto Volume** to **Off** on the TV. Otherwise, a change to the volume control of the source device may not be applied.

■ Reset Sound (OK / Cancel)

Reset all sound settings to the factory defaults. Select **OK**, press **ENTER** , select **OK** on the pop-up, and then press **ENTER**  again.



❑ Setting the Network Connection for LCD 550 series

■ Network Settings

 MENU  → Network → Network Settings → ENTER 

Set up your network connection so you can use AllShare™ and perform software upgrade.

■ Network Status

 MENU  → Network → Network Status → ENTER 

Let you check the current network and Internet status.

■ AllShare Settings

 MENU  → Network → AllShare Settings → ENTER 

Let you select whether to use media functions on the network. For details on set up options, refer to the “About AllShare™” instructions.

❑ Connecting to a Wired Network

There are three ways to attach your TV to your LAN using cable:

- You can attach your TV to your LAN by connecting the LAN port on the back of your TV to an external modem using a LAN cable. See the diagram below.

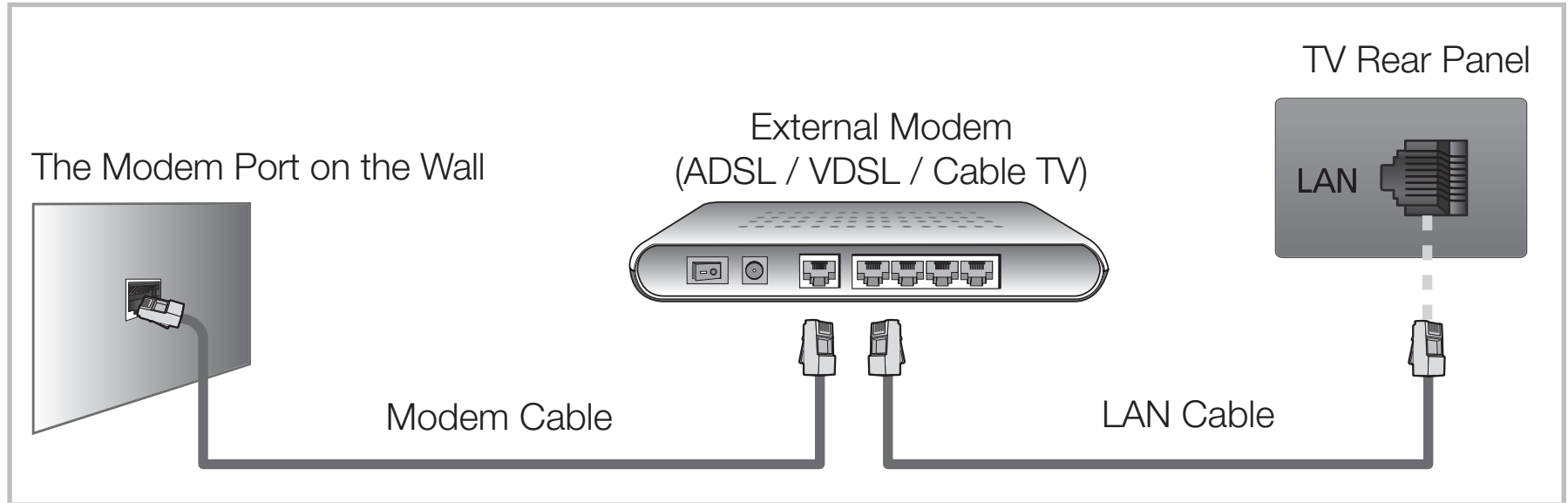

- You can attach your TV to your LAN by connecting the LAN port on the back of your TV to a IP Sharer (router) which is connected to an external modem. Use LAN cable for the connection. See the diagram below.

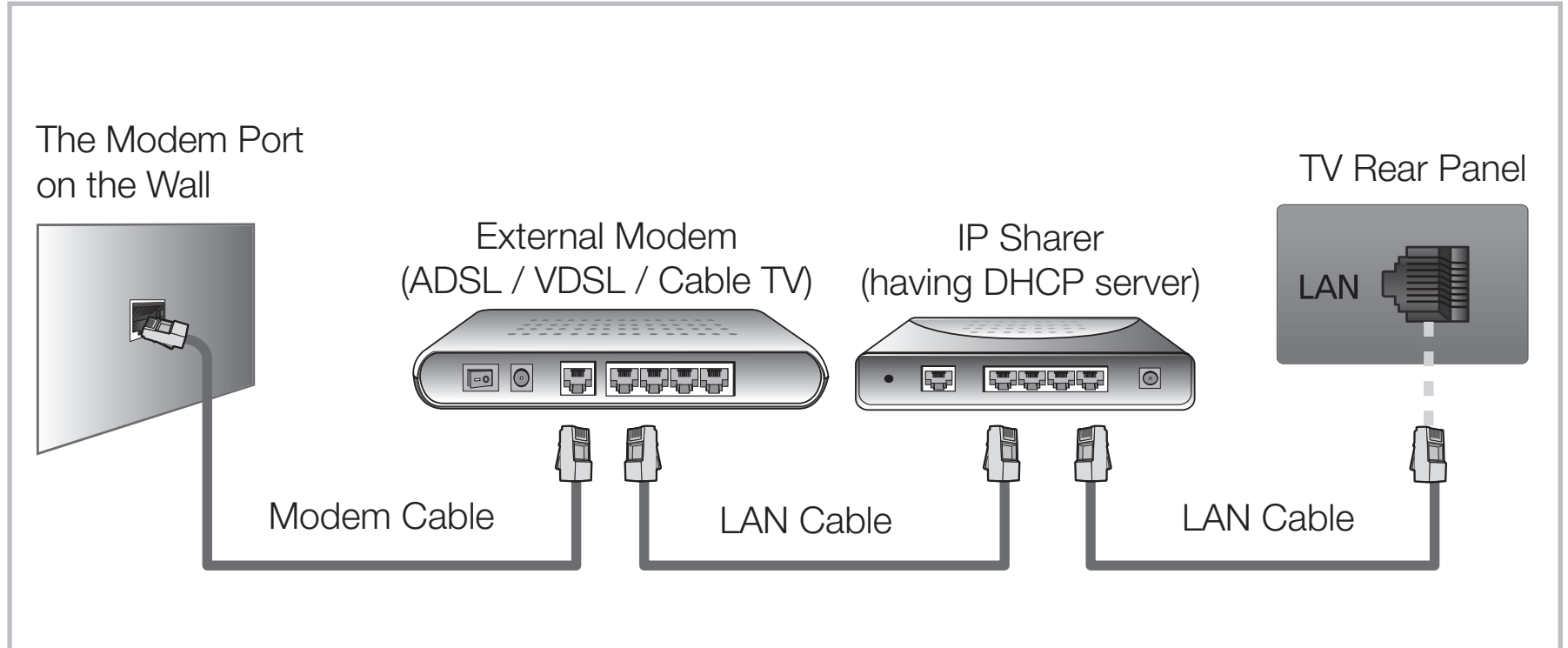

- Depending on how your network is configured, you may be able to attach your TV to your LAN by connecting the LAN port on the back of your TV directly to a network wall outlet using a LAN cable. See the diagram below. Note that the wall outlet is attached to a modem or router elsewhere in your house.

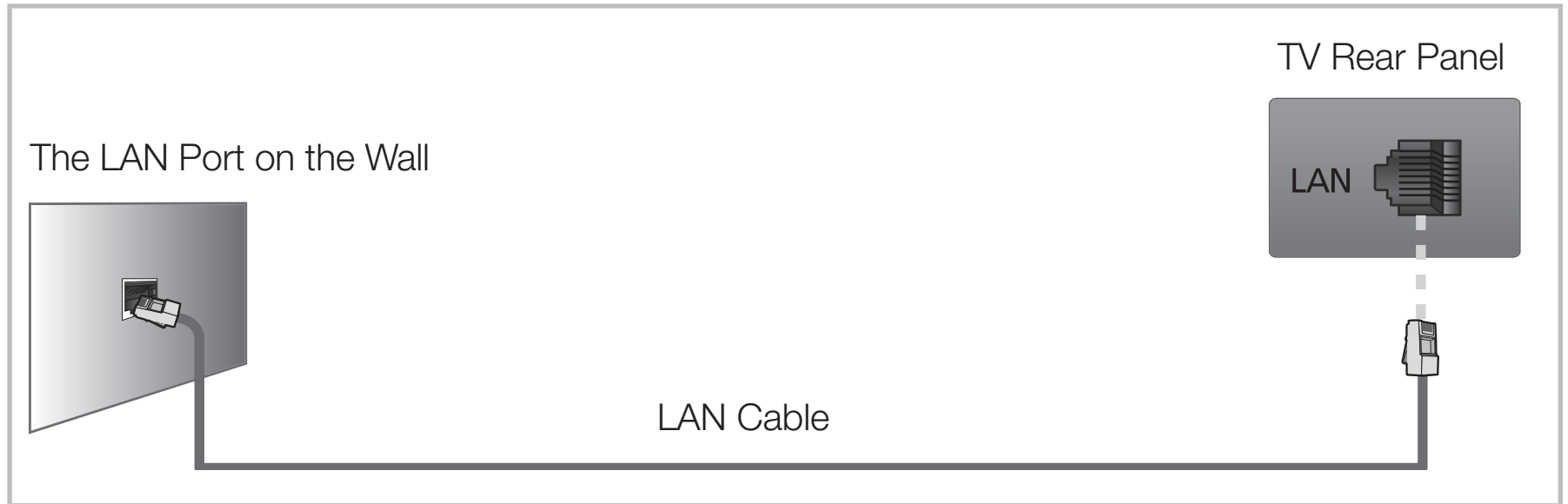

- If you have a Dynamic Network, you should use an ADSL modem or router that supports the Dynamic Host Configuration Protocol (DHCP). Modems and routers that support DHCP automatically provide the IP address, subnet mask, gateway, and DNS values your TV needs to access the Internet so you do not have to enter them manually. Most home networks are Dynamic Networks. Some networks require a Static IP address. If your network requires a Static IP address, you must enter the IP address, subnet mask, gateway, and DNS values manually on your TV's Cable Setup Screen when you set up the network connection. To get the IP address, subnet mask, gateway, and DNS values, contact your Internet Service Provider (ISP). If you have a Windows computer, you can also get these values through your computer.



 You can use ADSL modems that support DHCP if your network requires a Static IP address. ADSL modems that support DHCP also let you use Static IP addresses.

 A network speed of lower than 10 Mbps is not supported.

■ Automatic Network Setup

Use the Automatic Network Setup when connecting your TV to a network that supports DHCP. To set up your TV's cable network connection automatically, follow these steps:

How to set up automatically

1. Go to the **Network Settings** screen. (MENU  → **Network** → **Network Settings** → ENTER )
2. Select **Wired**, and then press **ENTER** .
3. The network connection screen appears and verifies the network connection. When the connection has been verified, the "**Internet is connected successfully.**" message appears.

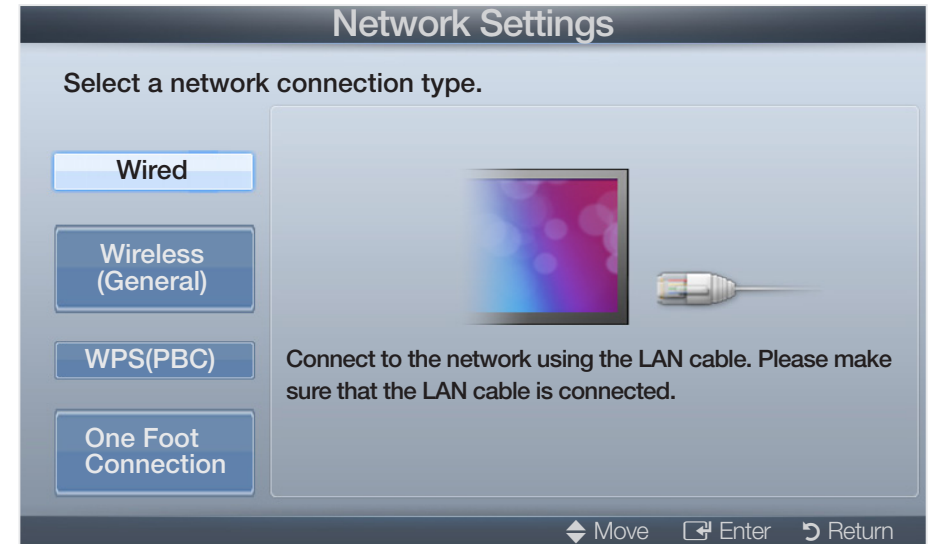

- ✎ If the connection process fails, check the LAN port connection.
- ✎ If the automatic process cannot find the network connection values or if you want to set the connection manually, go to the next section, Manual Network Setup.



■ Manual Network Setup

Use the Manual Network Setup when connecting your TV to a network that requires a Static IP address.





Getting the Network Connection Values

To view the Network connection values on most Windows computers, follow these steps:



1. Right click the Network icon on the bottom right of the screen.
2. In the pop-up menu that appears, click Status.
3. On the dialog that appears, click the Support tab.
4. On the Support Tab, click the Details button. The Network connection values are displayed.

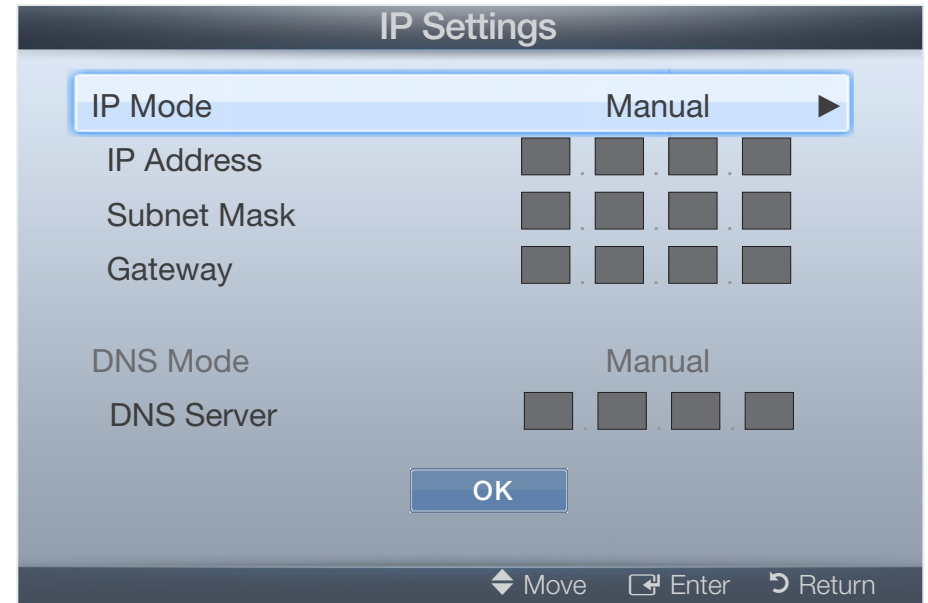

How to set up manually

To set up your TV's cable network connection manually, follow these steps:

1. Go to the **Network Settings** screen. (**MENU**  → **Network** → **Network Settings** → **ENTER** )
2. Select **Wired**, and then press **ENTER** . The network connection screen appears and the verification process starts.
3. Press **ENTER** . The verification process stops. Select **IP Settings** on network connection screen. The **IP Settings** screen appears.



4. In the top entry field, press **ENTER** , and then set **IP Mode** to **Manual**.
5. Press the ▼ button on your remote control to go to the IP Address entry field, and then press **ENTER** .
6. Enter the first portion of the IP Address (for example, 105) into the first entry field using the number keys on your remote control. Press the right arrow button to go to the next field.
7. Enter the next portion of the IP Address. Press the right arrow button to go to the next field.
8. Repeat the entry process for each field in the IP Address.
 -  If you make a mistake when entering a number, re-enter the number to correct it. You can also press the up or down arrow button to change the number one unit at a time.

9. When done entering **IP Address**, press **ENTER** .
10. Press the down arrow key to go to the Subnet Mask fields, and then press **ENTER** .
11. Repeat the same entry process for **Subnet Mask**, **Gateway**, and **DNS Server**.
12. When done, select **OK** at the bottom of the page, and then press **ENTER** . The network connection screen appears and the verification process starts. When the connection has been verified, the "**Internet is connected successfully.**" message appears.

❑ Connecting to a Wireless Network for LCD 550 series

To connect your TV to your wireless network, you need a wireless router or modem and a Samsung Wireless LAN Adapter (WIS09ABGN, WIS09ABGN2, or WIS10ABGN), which you connect to your TV's back or side panel USB port. See the illustration below.

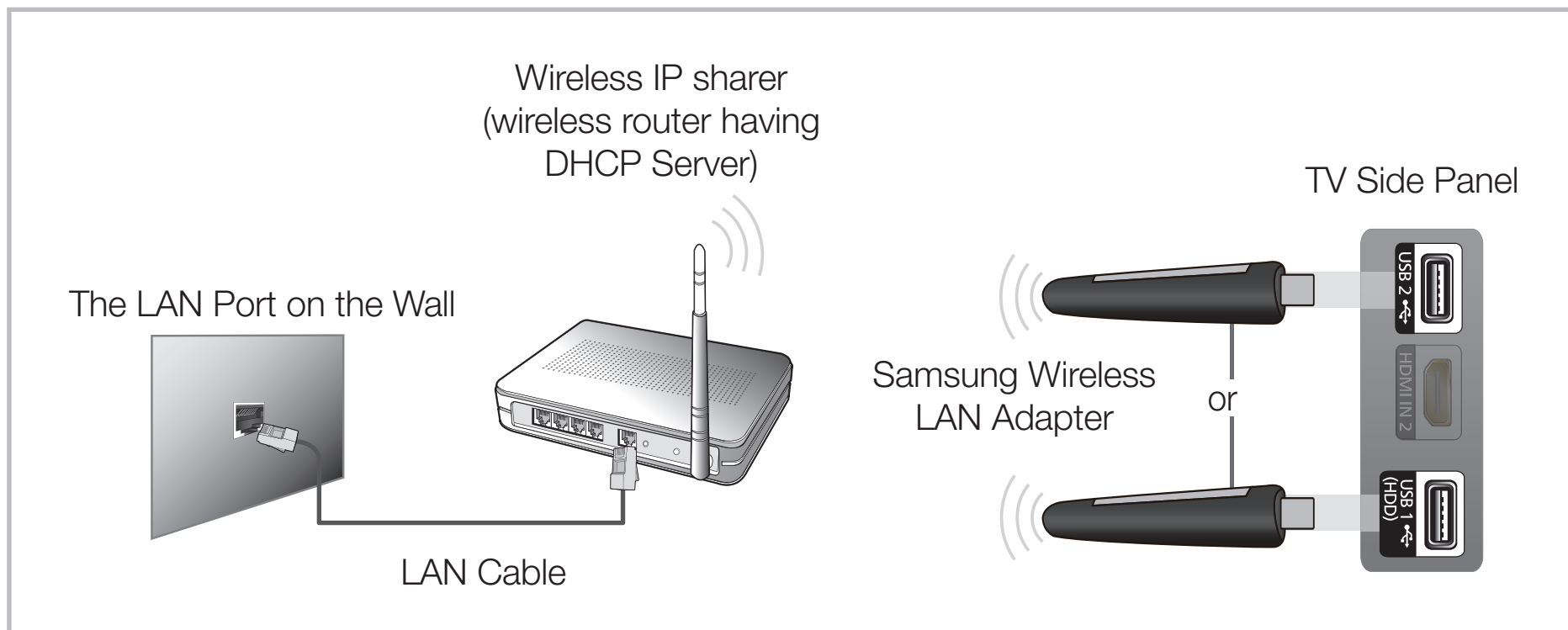

Samsung's Wireless LAN adapter is sold separately and is offered by selected retailers, Ecommerce sites, and Samsungparts.com. Samsung's Wireless LAN adapter supports the IEEE 802.11a/b/g and n communication protocols. Samsung recommends using IEEE 802.11n. When you play video over a network connection, the video may not be played smoothly.

 NOTE

- You must use the “Samsung Wireless LAN Adapter” (WIS09ABGN, WIS09ABGN2, or WIS10ABGN) to use a wireless network.
- Samsung Wireless LAN Adapter and The USB extension Cable are sold separately and are offered by selected retailers, Ecommerce sites and Samsungparts.com.
- To use a wireless network, your TV must be connected to a wireless IP sharer (either a router or a modem). If the wireless IP sharer supports DHCP, your TV can use a DHCP or static IP address to connect to the wireless network.

- Select a channel for the wireless IP sharer that is not currently being used. If the channel set for the wireless IP sharer is currently being used by another device nearby, this will result in interference and communication failure.
- Your TV supports the following wireless security systems only:
 - Authentication Mode: WEP, WPAPSK, WPA2PSK
 - Encryption Type: WEP, AES
- If you select the HIGH PURE THROUGHPUT (Greenfield) 802.11n mode and the Encryption type is set to WEP, TKIP or TKIP AES (WPS2Mixed) for your wireless router, Samsung TVs will not support a connection in compliance with new Wi-Fi certification specifications.
- If your wireless router supports WPS (Wi-Fi Protected Setup), you can connect to the network via PBC (Push Button Configuration) or PIN (Personal Identification Number). WPS will automatically configure the SSID and WPA key in either mode.

- If your router, modem, or device is not certified, it may not connect to the TV via the “Samsung Wireless LAN Adapter.”
- Ensure the TV is turned off before you connect the Samsung Wireless LAN Adapter.
- Connection Methods: You can setup the wireless network connection in five ways:
 - Auto Setup (Using the Auto Network Search function)
 - Manual Setup
 - **WPS (PBC)**
 - **One Foot Connection**
 - **Ad hoc**
- The TV may not recognize the Samsung Wireless LAN Adapter if it is connected to the TV using a USB hub or USB extension cable other than the cable supplied.

Notice

The picture may appear corrupted or have static for some channels when the TV is connected to the Samsung Wireless LAN Adapter. In such a case, establish a connection using one of the following methods or connect the Samsung Wireless LAN Adapter using a USB cable in a place that is not affected by radio interference.

Connecting the Samsung Wireless Adapter - Method 1

Connect using the USB right angle adapter.

To connect the Samsung Wireless LAN Adapter using the USB right angle adapter, follow these steps:

1. Connect the USB right angle adapter to the Samsung Wireless LAN Adapter.
2. Connect the other end of the right angle adapter to the USB port.



Connecting the Samsung Wireless Adapter - Method 2

Connect using the extension cable.

To connect the Samsung Wireless LAN Adapter using the extension cable, follow these steps:

1. Connect the extension cable to the USB port.
2. Connect the extension cable and Samsung Wireless LAN Adapter.
3. Using double-sided adhesive tape, attach the Samsung Wireless LAN Adapter to the back of the TV near the top.

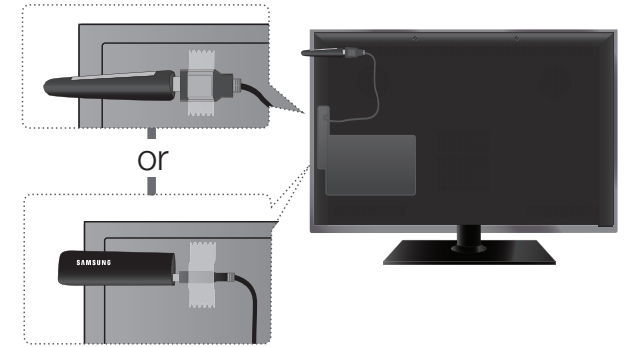



■ Automatic Network Setup



Most wireless networks have an optional security system that requires devices that access the network to transmit an encrypted security code called an Access or Security Key. The Security Key is based on a Pass Phrase, typically a word or a series of letters and numbers of a specified length you were asked to enter when you set up security for your wireless network. If you use this method of setting up the network connection, and have a Security Key for your wireless network, you will have to enter the Pass Phrase during the automatic or manual setup process.





How to set up automatically

1. Go to the **Network Settings** screen. (MENU  → **Network** → **Network Settings** → ENTER )
2. Select **Wireless (General)** and then press ENTER .
3. The Network function searches for available wireless networks. When done, it displays a list of the available networks.





- In the list of networks, press the ▲ or ▼ button to select a network, and then press the **ENTER**  button
-  If the wireless router is set to Hidden (Invisible), you have to select **Add Network** and enter the correct network **Name (SSID)** and Security key to establish the connection.
- If the Enter security key screen appears, go to step 6. If you select an wireless router that does not have security, go to step 8.

- Enter the security key (Security key or PIN), and then select **Done**.

-  When you enter the security key (Security or PIN), use ▲/▼/◀/▶ buttons on your remote control to select number/characters.
ENTER  to enter the characters.



-  You can also enter numbers by pressing the number buttons on your remote control.
-  You should be able to find the Pass Phrase on one of the set up screens you used to set up your router or modem.

7. When done, use the right arrow button to move the cursor to **NEXT**, and then press **ENTER** .

8. The network connection screen appears and the verification process starts. When the connection has been verified, the "**Internet connected successfully.**" message appears.

 If the network does not accept the Security key (Security or PIN), select **Retry** or select **IP Settings** to enter the settings manually.

 If you want to set up the connection manually, select **IP Settings**. Then, go to the next section, "How to set up manually".

■ Manual Network Setup

Use Manual Network Setup when connecting your TV to a network that requires a Static IP address or if the automatic connection process has failed.





Getting the Network Connection Values

To view the Network connection values on most Windows computers, follow these steps:

1. Right click the Network icon on the bottom right of the screen.
2. In the pop-up menu that appears, click Status.
3. On the dialog that appears, click the Support tab.
4. On the Support Tab, click the Details button. The Network connection values are displayed.

How to set up manually

To set up your TV's cable network connection manually, follow these steps:

1. Go to the **Network Settings** screen. (**MENU**  → **Network** → **Network Settings** → **ENTER** )
2. Select **Wireless (General)**, and then press **ENTER** .
3. The Network function searches for available wireless networks. When done, it displays a list of the available networks.
4. In the list of networks, press the ▲ or ▼ button to select a network, and then press the **ENTER**  button twice.
 -  If the wireless router is set to Hidden (Invisible), you have to select **Add Network** and enter the correct network **Name (SSID)** and Security key to establish the connection.

5. If the Enter security key screen appears, go to step 6. If you selected an AP or wireless router that does not have security, go to step 8.

6. Enter the security key (Security key or PIN), and then select **Done**.

 When you enter the security key (Security key or PIN), use ▲/▼/◀ /▶ buttons on your remote control to select number/characters.

ENTER 

 You can also enter numbers by pressing the number buttons on your remote control.

 You should be able to find the Pass Phrase on one of the set up screens you used to set up your router or modem.

7. When done, use the ► button to move the cursor to **NEXT**, and then press the **ENTER** ↵ button.
8. The network connection screen appears and the verification process starts. Press **ENTER** ↵ to cancel. Select **IP Setting** on network connection screen. The **IP Settings** screen appears.
9. In the top entry field, press **ENTER** ↵, and then set **IP Mode** to **Manual**.
10. Press the ▼ button on your remote control to go to the **IP Address** entry field, and then press **ENTER** ↵.
- ◀ 11. Enter the first portion of the **IP Address** (for example, 105) into the first entry field using the number keys on your remote control. Press the right arrow button to go to the next field. ▶
12. Enter the next portion of the **IP Address**. Press the right arrow button to go to the next field.

13. Repeat the entry process for each field in the **IP Address**.

 If you make a mistake when entering a number, re-enter the number to correct it. You can also press the up or down arrow button to change the number one unit at a time.

14. When done entering the **IP Address**, press **ENTER** .

15. Press the down arrow key to go to the **Subnet Mask** fields, and then press **ENTER** .





16. Repeat the same entry process for **Subnet Mask**, **Gateway**, and **DNS Server**.

17. When done, select **OK** at the bottom of the page, and then press **ENTER** . The network connection screen appears and the verification process starts. When the connection has been verified, the "**Internet connected successfully.**" message appears.

■ WPS(PBC) Network Setup

How to set up using WPS(PBC)

If your router has a PBC (WPS) button, follow these steps:

1. Go to the **Network Settings** screen. (MENU  → **Network** → **Network Settings** → **ENTER** )
2. Select **WPS(PBC)**, and press **ENTER** , then press **ENTER**  again.
3. Press the WPS(PBC) button on your router within 2 minutes.
Your TV automatically acquires all the network setting values it needs and connects to your network.
4. The network connection screen appears, and network set up is done.





■ One Foot Connection Network Setup



The **One Foot Connection** function lets you easily connect your Samsung TV automatically to a Samsung Wireless router. If your non-Samsung router does not support **One Foot Connection**, you must connect using one of the other methods.

 You can check for equipment that supports **One Foot Connection** on www.samsung.com.

How to Set Up Using One Foot Connection

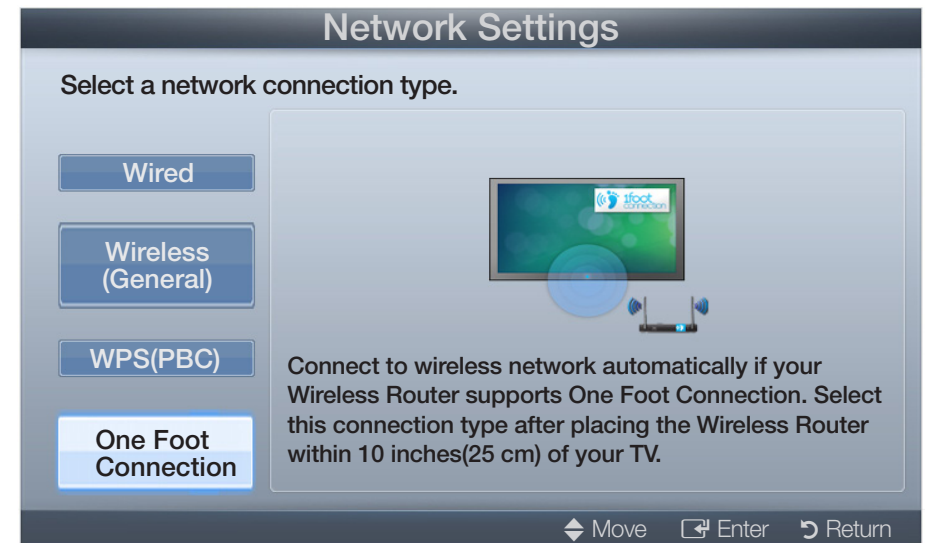
1. Turn on the router and your TV.
2. Go to the **Network Settings** screen. (MENU  → **Network** → **Network Settings** → ENTER )









3. Select **One Foot Connection**, and press **ENTER** , then press **ENTER**  again.
 4. Place the router in parallel with the Samsung Wireless LAN Adapter and no more than 10 inches (25cm) from the Adapter.
 5. Wait until the connection is automatically established.
 6. The network connection screen appears, and network set up is done.
 7. Move the router to a desired location.
-  If the router settings change or you install a new router, you must perform the **One Foot Connection** procedure again, beginning from Step 1.

■ Ad-Hoc Network Setup

You can connect to a mobile device that supports Ad-hoc connections - without going through a wireless router - using the “Samsung Wireless LAN Adapter”. After you connect the TV to a mobile device, you can use the files on device.

How to make an Ad-hoc connection

1. Go to the **Network Settings** screen. (**MENU**  → **Network** → **Network Settings** → **ENTER** ).
2. Select **Wireless (General)** and press **ENTER** , then press **ENTER**  again.
3. Select **Ad hoc**. The message "**Ad hoc service supports a direct connection with Wi-Fi compatible devices like a cell phone or PC. The existing network system may have limited functionality. Do you want to change the network connection?**" is displayed.

4. Select **OK**, and press **ENTER** . The TV searches for the mobile device.
5. When the TV finishes searching for mobile devices, input the generated **Network Name (SSID)** and **Security key** into the device you want to connect.
 -  If network does not operate normally, check the **Network Name (SSID)** and **Security key** again. An incorrect **Security key** may cause a malfunction.
 -  If a device is connected once, it is added to the Network Setting list. When you connect it again, you can find it in the Network Setting list.

If Your TV Fails to Connect to the Internet

Your TV may not be able to connect to the Internet because your ISP has permanently registered the MAC address (a unique identifying number) of your PC or modem, which it then authenticates each time you connect to the Internet as a way of preventing unauthorized access. As your TV has a different MAC address, your ISP can not authenticate its MAC address, and your TV can not connect.

To resolve this problem, ask your ISP about the procedures required to connect devices other than a PC (such as your TV) to the Internet.

If your Internet service provider requires an ID or password to connect to the Internet, your TV may not be able to connect to the Internet. If this is the case, you must enter your ID or password when connecting to the Internet.

The internet connection may fail because of a firewall problem. If this is the case, contact your Internet service provider.

If you cannot connect to the Internet even after you have followed the procedures of your Internet service provider, please contact Samsung Electronics at 1-800-SAMSUNG.

□ Setting the Time

 MENU  → System → Time → ENTER 

■ Time

 The current time will appear every time you press the **INFO** button.

- **Clock:** Set the clock to use the various timer features of the TV.

 If you disconnect the power cord, you have to set the clock again.



Clock Mode: Set the current time manually or automatically.

- **Auto:** The TV sets the current time automatically using the time from a digital channel.

 You must have cable or an antenna connected to the TV to set the time automatically.

- **Manual:** Set the current time manually.
 - ☞ Depending on the broadcast station and signal, the auto time set up may not be correct. In this case, set the time manually.

Clock Set: Set the **Month**, **Day**, **Year**, **Hour**, **Minute** and **am/pm**.

Select **Clock Set**. Select date or time, and then press **ENTER** . Use the number buttons or the up and down arrow buttons to enter numbers. Use the left and right arrow buttons to move from one entry field to the next. Press **ENTER**  when done. To exit **Clock Set**, select **Close**, and press **ENTER** .

☞ Available only when **Clock Mode** is set to **Manual**.

DST (Off / On): Switches the DST (Daylight Saving Time) function on or off.

 This function is only available when the **Clock Mode** is set to **Auto**.

Time Zone: Select your time zone.

 This function is only available when the **Clock Mode** is set to **Auto**.

Using the Sleep Timer

 MENU  → **System** → **Time** → **Sleep Timer** → ENTER 

- **Sleep Timer** : Automatically shuts off the TV after a preset period of time. (30, 60, 90, 120, 150 and 180 minutes).

 Use the up and down arrows to select a period of time, and then press **ENTER**  To cancel the **Sleep Timer**, select **Off**.

❑ Setting the On/Off Timer

 MENU  → System → Time → ENTER 

Set **On Timer** so that your TV turns on automatically at a time and on a day of your choosing.

- **On Timer:** You can set up three separate **On Timer** configurations. (**On Timer 1**, **On Timer 2**, **On Timer 3**)

 You must set the clock before you can use **On Timer**.

Setup: Select **Off**, **Once**, **Everyday**, **Mon~Fri**, **Mon~Sat**, **Sat~Sun** or **Manual**. If you select **Manual**, you can choose the days you want **On Timer** to turn on your TV.

 The ✓ mark indicates days you've selected.



On Time: Set the hour, minute, am/pm. Use the number buttons or the up and down arrow keys to enter numbers. Use the left and right arrow buttons to change entry fields.

Volume: Set the desired volume level. Use the left and right arrow buttons to change the volume level.





Source: Select **TV** or **USB**. Select TV and the TV will display broadcast or cable TV programs when it turns on automatically. Select USB and the TV will play content from a USB device when the TV turns on automatically. (You can select USB only when a USB device is connected to the TV)

Antenna (when the **Source** is set to **TV**): Select **Air** or **Cable**.

Channel (when the **Source** is set to **TV**): Select the desired channel.

Music / Photo (when the **Source** is set to **USB**): Select a folder in the USB device containing the music or photo files you want to play when the TV turns on automatically.

 If there is no music file on the USB device or you don't select a folder containing a music file, the Timer function does not operate correctly.

-  If there is only one photo file in the USB, the Slide Show will not play.
-  A folder with a name that is too long cannot be selected.
-  Each USB device you use is assigned its own folder. When using more than one of the same type of USB device, make sure the folders assigned to each USB device have different names.
-  It is recommended that you use a USB memory stick and a multi card reader when using **On Timer**.
-  The **On Timer** function may not work with USB devices with a built-in battery, MP3 players, or PMPs made by some manufacturers because these devices take a long time to be recognized.

- **Off Timer:** You can set up three separate **Off Timer** configurations. (**Off Timer 1**, **Off Timer 2**, **Off Timer 3**)

 You must set the clock before you can use **Off Timer**.

Setup: Select **Off**, **Once**, **Everyday**, **Mon~Fri**, **Mon~Sat**, **Sat~Sun** or **Manual** If you select **Manual**, you can choose the days you want **Off Timer** to turn off your TV.

 The ✓ mark indicates days you've selected.

Off Time: Set the hour, minute, and am/pm. Use the number buttons or the up and down arrow keys to enter numbers. Use the left and right arrow buttons to change entry fields.

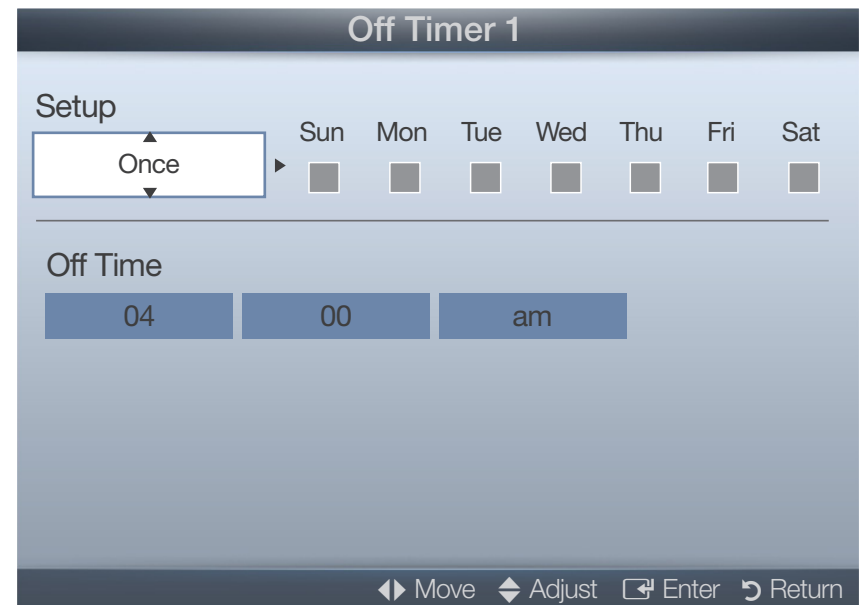

❑ Blocking Programs

 MENU  → System → Security → ENTER 

■ Security

When you access the Security functions for the first time, the PIN input screen appears. Enter a 4 digit PIN you will remember. The PIN screen closes and the Security Menu appears. Every time you access the Security functions, the PIN screen appears and you must enter that PIN.

- **Program Rating Lock (Off/On):** When **On**, lets you block TV programs based on their ratings.

 The default PIN number for a new TV set is “0-0-0-0”.

TV Rating: Lets you you block TV programs based on their ratings. This function allows you to control which TV programs your children can watch. **TV Rating** displays a grid with locks. The following categories are on the left side:



- **TV-Y:** Young children / **TV-Y7:** Children 7 and over / **TV-G:** General audience / **TV-PG:** Parental guidance / **TV-14:** Viewers 14 and over / **TV-MA:** Mature audience

The following categories are on top:

- **ALL** **FV:** Fantasy violence / **V:** Violence / **S:** Sexual situation / **L:** Adult Language / **D:** Sexually Suggestive Dialog

To block certain content, you select a lock, and press **ENTER**  (That is, you “click it”). For example, click the lock at the intersection of V and TV-MA, and you block all programs that are rated violent and for mature adults. The locks are also assigned to related groups. For example, if you click **TV-Y** under **ALL**, then **TV-Y7** will also automatically be blocked.

Similarly, if you click **TV-G** under **ALL**, then all the categories in the young adult group will be blocked (**TV-G**, **TV-PG**, **TV-14** and **TV-MA**). The sub-ratings (**D**, **L**, **S**, **V**) work similarly. So, if you block the L sub-rating in **TV-PG**, then the L sub-ratings in **TV-14** and **TV-MA** will automatically be blocked.

-  To unblock a category, click the lock. To unblock all the categories in a row, click the lock under **ALL**.
-  To watch a blocked program, you must enter the Security code when requested.

Movie Rating (MPAA): You can block movies based on their MPAA rating. The Motion Picture Association of America (MPAA) has implemented a rating system that provides parents or guardians with advanced information on which films are appropriate for children.

Movie Rating displays a column with locks and the following ratings categories:

- **G:** General audience (no restrictions). / **PG:** Parental guidance suggested. / **PG-13:** Parents strongly cautioned. / **R:** Restricted. Children under 17 should be accompanied by an adult. / **NC-17:** No children under age 17. / **X:** Adults only. / **NR:** Not rated.

To block certain content, you select a lock, and press **ENTER**  (That is, you “click it”). For example, click the **X** lock and you block all X-rated movies. The rating categories are also grouped so that clicking one category blocks all the categories a parent would block along with it. For example, if you block the **PG-13** category, then **R**, **NC-17** and **X** will automatically be blocked also.

 To unblock a category, click the lock.

Canadian English Rating: You can block TV programs based on their Canadian English rating.

Canadian English Rating displays a column with locks and the following ratings categories:

- **C:** Programming intended for children under age 8. / **C8+:** Programming generally considered acceptable for children 8 years and over to watch on their own. / **G:** General programming, suitable for all audiences. / **PG:** Parental Guidance. / **14+:** Programming contains themes or content which may not be suitable for viewers under the age of 14. / **18+:** Adult programming.

To block certain content, you select a lock, and press **ENTER**  (That is, you “click it”). For example, click the 18+ lock and you block all TV programs rated 18+. The rating categories are also grouped so that clicking one category blocks all the categories a parent would block along with it. For example, if you block the **G** category, then **PG**, **14+** and **18+** will automatically be blocked.

 To unblock a category, click the lock.

Canadian French Rating: You can block TV programs based on their French Canadian rating.

Canadian French Rating displays a column with locks and the following ratings categories:

- **G:** General / **8 ans+:** Programming generally considered acceptable for children 8 years and over to watch on their own. / **13 ans+:** Programming may not be suitable for children under the age of 13. / **16 ans+:** Programming is not suitable for children under the age of 16. / **18 ans+:** Programming restricted to adults.

To block certain content, you select a lock, and press **ENTER**  (That is, you “click it”). For example, click the 18 ans+ lock and you block all TV programs rated 18 ans+. The rating categories are also grouped so that clicking one category blocks all the categories a parent would block along with it. For example, if you block the **8 ans+** category, then **13 ans+**, **16 ans+** and **18 ans+** will automatically be blocked also.

 To unblock a category, click the lock.

Downloadable U.S. Rating: Parental restriction information you can use while watching DTV channels.

 NOTE

- If information is not downloaded from the broadcasting station, **Downloadable U.S. Rating** menu is deactivated.
- Parental restriction information is automatically downloaded while you watch DTV channels. It may take several seconds.
- The **Downloadable U.S. Rating** menu is available for use after information is downloaded from the broadcasting station. However, depending on the information from the broadcasting station, it may not be available for use.

- Parental restriction levels differ depending on the broadcasting station. The default menu name and **Downloadable U.S. Rating** change depending on the downloaded information.
- Even if you set the on-screen display to another language, the **Downloadable U.S. Rating** menu will appear in English only.
- Blocking one rating level will automatically block other categories that deal with more sensitive material.
- The rating titles (For example: Humor Level..etc) and TV ratings (For example: DH, MH, H..etc) may differ depending on the broadcasting station.

- **Change PIN:** The **Change PIN** screen will appear. Choose any 4 digits for your PIN and enter it in **Enter New PIN**. Re-enter the same 4 digits in **Confirm New PIN**. When the Confirm screen appears, press the **OK** button. The TV has memorized your new PIN.

How to watch a restricted program or movie

If the TV is tuned to a restricted program or movie, the **Program Rating Lock** will block it. The screen will go blank and the following message will appear:

This channel is blocked by Program Rating Lock. Please enter the PIN to unblock. Enter the PIN to unblock the program or movie.

- ☞ If you forget the PIN code, press the remote control buttons in the following sequence in Standby mode, which resets the PIN to “0-0-0-0” :
MUTE → 8 → 2 → 4 → **POWER** (on)

□ Picture In Picture (PIP)

 MENU  → System → PIP → ENTER 

■ PIP TOOLS

You can watch a program whose signal has passed through the TV's tuner and watch one external video source simultaneously. For example, if you have a cable box connected to the Cable In jack, you can use **PIP** to watch programs from the cable box and watch a movie from a Blu-ray player attached to the HDMI In jack.







NOTE

- For PIP sound, refer to the **Sound Select** instructions.
- If you turn the TV off while watching in the PIP mode, the PIP function is reset to off. When you turn your TV on, you must turn PIP on again to watch in the PIP mode.

- You may notice that the picture in the PIP window becomes slightly unnatural when you use the main screen to view a game or karaoke.
- When **Program Rating Lock** is on, you cannot use **PIP**.
- PIP Settings

The picture from the external video source will be in the main screen and the picture from the TV's tuner will be in the PIP sub-picture window.

Main picture	Sub picture
Component, HDMI, PC	TV

- **PIP (Off / On)**: Activate or deactivate the PIP function.
- **Air/Cable (Air / Cable)**: Select either **Air** or **Cable** as the input source for the sub-screen.
- **Channel**: Select the channel for the sub-screen.
- **Size** ( / ): Select a size for the sub-picture.
- **Position** ( /  /  / ): Select a position for the sub-picture.
- **Sound Select (Main / Sub)**: You can choose to listen to the sound from the **Main** picture or the **Sub** picture.

Economical Solutions

Eco Solution

- **Energy Saving (Off / Low / Medium / High / Picture Off)**: Lets you adjust the brightness of the TV in order to reduce power consumption. If you select **Picture Off**, the screen is turned off, but the sound remains on. Press any button to turn on the screen again.
- **Eco Sensor (Off / On)** for LCD 550 series: To enhance your power savings, the picture settings will automatically adapt to the light in the room.

 If you adjust **Backlight** in the Picture menu, **Eco Sensor** is set to **Off**.

Min Backlight: When **Eco sensor** is **On**, lets you manually adjust the minimum screen brightness.

 If **Eco Sensor** is **On**, the display brightness may change (become slightly darker in most cases) depending on the surrounding light intensity. You can control the screen's minimum brightness with the **Min Backlight** function.

- **No Signal Power Off (Off / 15 min. / 30 min. / 60 min.):** Sets how quickly the TV switches to standby mode if it is receiving no signal.

 Disabled when an attached PC is in power saving mode.



- **Auto Power Off (Off / On):** The TV will automatically turn off if you don't press a button on the remote control or touch a button on TV's front panel within 4 hours.

❑ Other Features

 MENU  → System → ENTER 

■ Menu Language

Set the menu language.

1. Select **Menu Language**, and then press the **ENTER**  button.
2. Choose a language, and then press the **ENTER**  button.
 -  Choose **English** **Español**, or **Français**

■ Caption

(On-Screen Text Messages)

- **Caption (Off / On):** You can switch the caption function on or off. If captions are not available, they will not be displayed on the screen.

 The Caption feature does not work with devices connected to the TV through the Component, HDMI or PC input jacks.

- **Caption Mode:** You can select the desired caption mode.

 The availability of captions depends on the program being broadcasted.

◀ **Default / CC1 ~CC4 / Text1 ~Text4:** (analog channels only) The Analog Caption function operates in either analog TV channel mode or when a signal is supplied from an external device to the TV. (Depending on the broadcasting signal, the Analog Caption function may or may not work with digital channels.) ▶

Default / Service1 ~Service6 / CC1 ~CC4 / Text1 ~Text4: (digital channels only) The Digital Captions function works with digital channels.

 **Service1 ~6** may not be available in digital caption mode depending on the broadcast.

- **Digital Caption Options:** (digital channels only)

Size: Options include Default, Small, Standard and Large. The default is Standard.

Font Style: Options include Default and Styles 0 to 7. The default is Style 0.

Foreground Color: You can change the color of the letters. Options include Default, White, Black, Red, Green, Blue, Yellow, Magenta and Cyan. The default is White.

Background Color: You can change the background color of the caption. Options include Default, White, Black, Red, Green, Blue, Yellow, Magenta and Cyan. The default is Black.

Foreground Opacity: This adjusts the opacity of text. Options include Default, Transparent, Translucent, Solid and Flashing.

Background Opacity: This adjusts the opacity of the caption background. Options include Default, Transparent, Translucent, Solid and Flashing.

Return to Default: This option sets Size, Font Style, Foreground Color, Background Color, Foreground Opacity, and Background Opacity to their defaults.



NOTE

- **Digital Caption Options** are available only when you can select **Default** and **Service1 ~ Service6** in **Caption Mode**.
- The availability of captions depends on the program being broadcast.
- The **Default** setting follows the standards set by the broadcaster.
- You cannot set the Foreground and Background to the same color.
- You cannot set both the **Foreground Opacity** and the **Background Opacity** to Transparent.

■ Auto Protection Time

- **Auto Protection Time (Off / 2 hours / 4 hours / 8 hours / 10 hours):** If the screen remains idle with a still image for a period of time you define, the TV activates the screen saver to prevent the formation of burnt in ghost images on the screen.



■ General

- **Game Mode (Off / On):** When you have connected a game console such as PlayStation™ or Xbox™ to the TV, you can enjoy a more realistic gaming experience if you set **Game Mode** on.

NOTE

- Precautions and limitations for **Game Mode**:
 - Before disconnecting a game console and connecting another external device, set **Game Mode** to **Off**.
 - If you display the TV menu in **Game Mode**, the screen shakes slightly.

- **Game Mode** is not available when you've set the input source to **TV** or **PC**.
- Set **Game Mode** to **On** only after connecting a game console. If you turn Game Mode on before you have attached the game console, you may notice reduced picture quality.
- If **Game Mode** is **On**:
 - **Picture Mode** is set to **Standard** and **Sound Mode** is set to **Movie**.

- **Menu Transparency (Bright / Dark)**: Set the Transparency of the menu.
- **Boot Logo (Off / On)**: Display the Samsung logo when the TV is turned on.
- **TV name** **for LCD 550 series**: Lets you change the TV's name by selecting from a list of names (for example, Home TV) or by keying in a name manually.
 - ☞ If you select **User Input**, a keyboard appears on the screen and you can key in a name for your TV manually using your remote control.

■ Anynet+ (HDMI-CEC)

For details on set up options, refer to the “[Anynet+ \(HDMI-CEC\)](#)” instructions.



■ DivX® Video On Demand

Shows the registration code authorized for the TV. If you connect to the DivX web site and register using that code, you can download the VOD registration file. If you activate the VOD registration using **My Contents**, the registration is completed.

 For more information about DivX® VOD, visit “<http://vod.divx.com>”.

■ **Network Remote Control (On / Off)** for LCD 550 series

Turn on/off or give permission to Samsung mobile phones devices to connect with and control the TV.

You must have a Samsung Mobile phone/device which supports Network Remote Control. For more details, refer to each device's manual.



Support Menu

 MENU  → Support → ENTER 

■ e-Manual

You can read the introduction and instructions about the TV features stored in your TV.

 For the detailed information about e-Manual Screen, refer to “How to view the e-Manual” in the User Manual.

■ Self Diagnosis

- **Picture Test (Yes / No):** Use to check for picture problems. Picture test displays a high definition picture that you can examine for flaws or faults.
Yes: Select Yes if the test picture does not appear or there is noise or distortion in the test picture. There may be a problem with the TV. Contact Samsung's Call Center for assistance.
No: Select No if the test picture displays properly. There may be a problem with your external equipment. Please check your connections. If the problem persists, refer to the external device's user manual.

- **Sound Test (Yes / No):** Use to check for sound problems. Sound test plays a built-in melody that tests both speakers.

 If you hear no sound from the TV's speakers, before performing the sound test, make sure **Speaker Select** is set to **TV Speaker** in the **Sound** menu, and then try the speakers again.

 You will hear the melody during the test even if you have set **Speaker Select** to **External Speaker** or have muted the sound by pressing the **MUTE** button.

Yes: Select Yes if you can hear sound from only one speaker or from neither speaker during the sound test. There may be a problem with the TV. Contact Samsung's Call Center for assistance.

No: Select No if you can hear sound from the speakers. There may be a problem with your external equipment. Please check your connections. If the problem persists, refer to the external device's user manual.

- **Signal Information:** (digital channels only) The reception quality of over-the-air HD channels is either perfect or the channels are unavailable. Signal Information displays HD channel signal strength so you can adjust your antenna to increase signal strength and receive HD channels.
- **Troubleshooting:** Displays a troubleshooting guide organized into four symptom categories: Poor or Distorted Picture, Distorted Sound or No Sound, RF or PC Issues, and Other Issues. If your TV seems to be having a problem, access the trouble shooting guide for a solution.
 -  If none of these troubleshooting tips apply, contact the Samsung customer service center.

■ Software Upgrade

The **Software Upgrade** menu lets you upgrade your TV's software to the latest version.

Current Version: This is the software version already installed in the TV.

 The current version is displayed in the following format: Year/Month/Day_Version number.

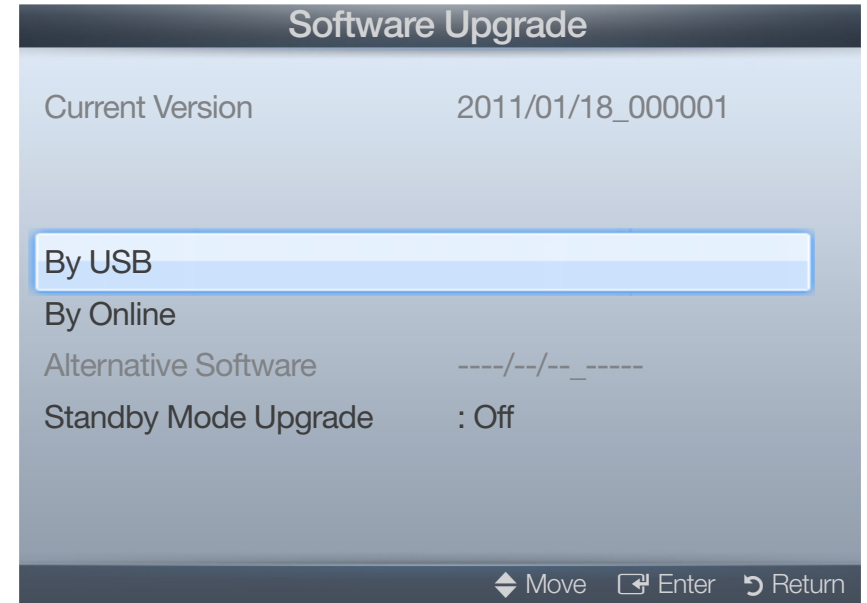

* The screen may differ depending on the model.

Upgrading to the Latest Version

You can upgrade in three ways:

- By USB
- By Internet
- By Standby Mode Upgrade

The three methods are explained in the following pages.

 Be careful not to turn off the power until the upgrade is complete. The TV will turn off and on automatically after completing the firmware upgrade. When you upgrade software, all video and audio settings you have made will return to their default settings. We advise you to write down your settings so that you can easily reset them after the upgrade.

By USB

To upgrade by USB, follow these steps:

1. Visit www.samsung.com.
2. Download the latest USB software upgrade exe archive to your computer.
3. Copy the folder to a USB flash drive.
4. Turn on the TV, and then insert the USB flash drive into the USB port of the TV.
5. In the TV's menu, go to **MENU** → **Support** → **Software Upgrade**.
6. Select **By USB**.



Please be careful not to remove the USB drive until the upgrade is complete.

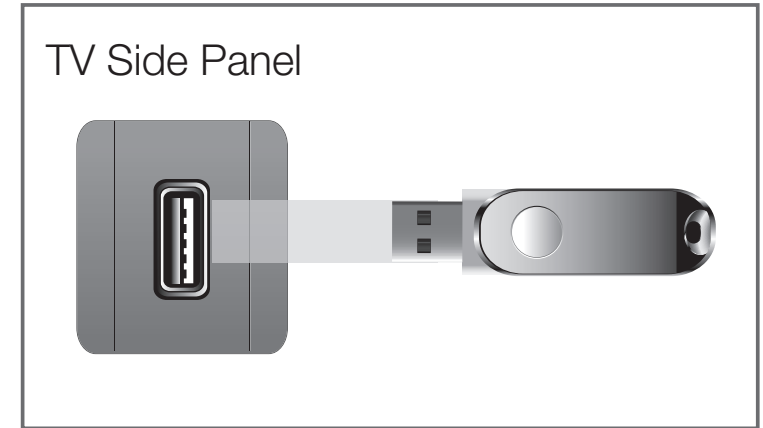

The placement of the USB jack may differ depending on the model.

By Online for LCD 550 series

The **By Online** function lets you download the upgrade software directly from the Internet into your TV and then upgrade the software in one operation. To use By Online, you must have configured your TV to connect to your network and the TV must be connected to the Internet. See the Network Connection instructions.

To upgrade by Online, follow these steps:

1. Select **By Online**, and then press the **ENTER**  button. The Connecting to Server message appears.
2. If there is a download available, the Download pop-up appears with a progress bar and the download starts.

3. When the download is complete, the Upgrade Query window appears with three choices: Upgrade Now, Upgrade Later, or Don't Upgrade.
4. If you select Upgrade Now, the TV upgrades the software, turns off, and then turns on automatically.
5. If you do not make a selection in one minute or select Upgrade Later, the TV stores the new upgrade software. You can upgrade the software later using the Alternative Software function.
6. If you select Don't Upgrade, the TV cancels the upgrade.

Alternative Software

The **Alternative Software** option lets you upgrade using a file the TV downloaded earlier, but you decided not to install immediately, or a file downloaded by the TV in **Standby Mode Upgrade** (See **Standby Mode Upgrade** on the next page).

To upgrade by **Alternative Software**, follow these steps:

1. If upgrade software has been downloaded, you will see the software version number to the right of **Alternative Software**.
2. Select **Alternative Software**, and then press the **ENTER**  button.
3. The TV displays a message asking if you want to upgrade. Select **Yes**. The TV begins the upgrade.
4. When the update is complete, the TV turns off automatically, and then turns on.

Standby Mode Upgrade for LCD 550 series

You can set the **Standby Mode Upgrade** function so that the TV downloads new upgrade software when it is in Standby mode. In Standby mode, the TV is off, but its Internet connection is active. This allows the TV to download upgrade software automatically, when you are not using it. Because the TV is turned on internally, the screen may glow slightly. This phenomenon may continue for more than 1 hour until the software download is complete.

To set **Standby Mode Upgrade**, follow these steps:

1. Select **Standby Mode Upgrade**, and then press the **ENTER**  button.
2. Select **On** or **Off**.
 - **Off**: If you select **Off**, the TV will notify you with a pop up message when new upgrade software is available.

- **On**: If you select **On**, the TV will automatically download new upgrade software when it is in Standby mode with the power off. If it downloads new upgrade software, the TV will ask you if you want to install it when you turn the TV on.



To use the **Standby Mode Upgrade** function, your TV must be connected to the Internet.



■ **Contact Samsung**

View this information when your TV does not work properly or when you want to upgrade the software. You can find information regarding our call centers and how to download products and software.

■ **Contents Home**

You can enjoy useful and various contents.



❑ Using the My Contents

Enjoy photos, music and movie files saved on a USB Mass Storage Class (MSC) device and your PC.

1. Press the **CONTENT** button to select **My Contents**.
2. Press **▲/▼** button to select desired menu (**Videos**, **Photos**, **Music**), then press the **ENTER**  button.

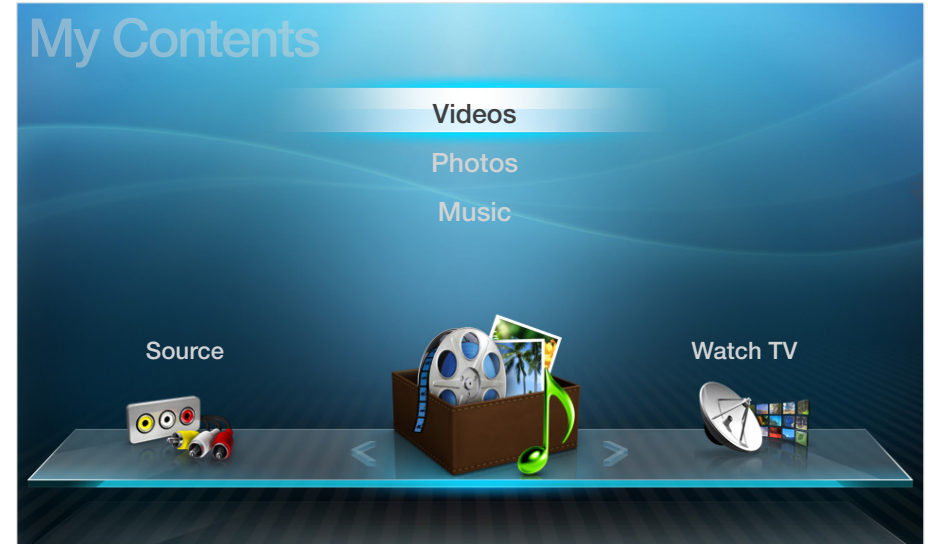

The **My Contents** main screen. Use the left and right arrow buttons to change from one main category to another (from **My Contents** to **Watch TV** to **Source**.)

- ☞ To view content on a USB device, you must plug the device into a USB jack on the TV.
- ☞ To view content located on your PC, you must have connected your TV and your PC to your LAN and downloaded and installed AllShare PC Software on your PC.

☐ Connecting a USB Device

1. Turn on your TV.
2. Connect a USB device containing photo, music and movie files to the USB jack on the side of the TV.
3. When a USB device is connected to the TV, the **Connected Device** window appears. Select a connected device, and then press **ENTER** .

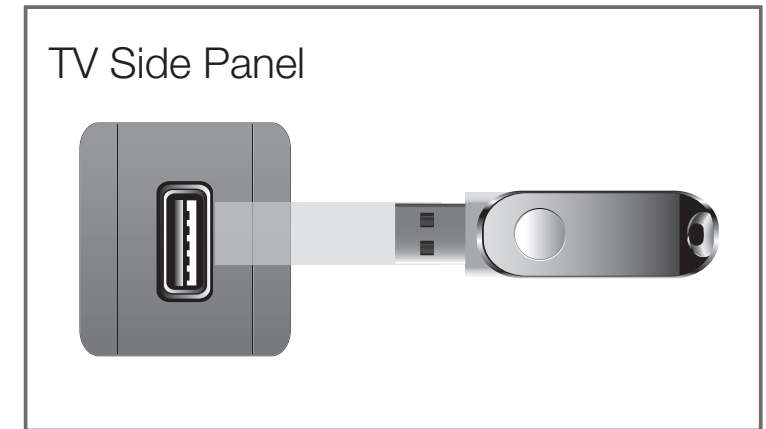

The placement of the USB jack may differ depending on the model.

 The USB function might not work properly with unlicensed multimedia files.

 Read this information before using **My Contents** with a USB device:

- MTP (Media Transfer Protocol) is not supported.
- The file system supports FAT16, FAT32 and NTFS.
- Certain types of USB Digital camera and audio devices may not be compatible with this TV.
- **My Contents** only supports USB Mass Storage Class (MSC) devices. MSC is a Mass Storage Class Bulk-Only Transport device. Examples of MSC are Thumb drives, Flash Card Readers and USB HDD (USB HUB are not supported). Devices should be connected directly to the TV's USB port.
- Before connecting your device to the TV, please back up your files to prevent them from damage or loss of data. SAMSUNG is not responsible for any data file damage or data loss.

- USB (HDD) is not supported. **for LCD 450 series**
- Connect USB HDDs to the dedicated port, USB 1 (HDD), only. **for LCD 550 series**
- Do not disconnect the USB device while it is loading.
- The higher the resolution of the image, the longer it takes to display on the screen.
- The maximum supported JPEG resolution is 15360 x 8640 pixels.
- If a file is corrupted or the TV does not support the file type, the “Not Supported File Format” message appears.
- If the files are sorted by **Folder View**, the TV can display the names of up to 1000 files in each folder.







- The TV cannot play MP3 files with DRM that have been downloaded from a for-pay site. Digital Rights Management (DRM) is a technology that supports the creation, distribution, and management of digital content in an integrated and comprehensive way, including protecting the rights and interests of content providers, preventing illegal copying of contents, and managing billings and settlements.
- If more than 2 PTP devices are connected, you can only use one at a time.
- If more than two MSC devices are connected, some of them may not be recognized. A USB device that requires high power (more than 500mA or 5V) may not be supported.
- If an over-power warning message is displayed while you are connecting or using a USB device, the device may not be recognized or may malfunction.

- If the TV has no input during the time set in **Auto Protection Time**, the Screensaver will run.
- The power-saving mode of some external hard disk drives may be released automatically when you connect them to the TV.
- If you use a USB extension cable, the TV may not recognize the USB device or may not be able to read the files on the device.
- If a USB device connected to the TV is not recognized, the list of files on the device is corrupted, or a file in the list is not played, connect the USB device to a PC, format the device, and check the connection.
- If a file you deleted from the PC is still found when you run **My Contents**, use the “Empty the Recycle Bin” function on the PC to permanently delete the file.
- **My Contents** only supports sequential jpeg format.
- The scene search and thumbnail functions are not supported in the **Videos**.
- If the number of files and folders saved on a USB storage device is approximately over 4000, the files and folders may not appear and some folders may not be opened.

❑ **Connecting to a PC through your network** for LCD 550 series



You can play pictures, music, and videos saved in your PC through a network connection using **My Contents** over your TV.

- ✎ To use **My Contents** to play files saved in your PC on your TV, you must download “AllShare PC Software” and the AllShare PC Software users manual from “www.samsung.com”.
- ✎ For more information on how to configure your TV and connect it to your network, see ‘Network Connection’.
- ✎ We recommend you locate both your TV and PC in the same network subnet. IP addresses have four parts separated by periods (111.222.333.444). If your TV and PC are in the same subnet, the first 3 parts of the TV IP address and the PC IP address (111.222.333) will be the same and only the last part (the host address) will be different.

-  You need a router and/or modem to connect your PC to the Internet. For information about connecting your PC to your network, see the instructions for the router or modem.
-  The following **My Contents** functions that are not supported when you are playing media from a PC connected through a network:
 - The **Background Music** and **Background Music Setting** functions.
 - The  (REW) or  (FF) button while a movie is playing.
-  The DivX DRM, Multi-audio, embedded caption is not supported.
-  Set your PC firewall program so that AllShare PC Software is a permitted program.



Depending on the Internet server, when you use **My Contents** through a network connection:

- The sorting method may vary.
- The **Play Continuously** function, which resumes the playing of a video, may not be supported.
 - The **Play Continuously** function does not support multiple users. (It memorizes only the point where the most recent user stopped playing a video.)
- The  (REW),  (FF) or  (Pause) buttons may not work depending on the content information.



If you experience any file stuttering issues while playing a video over a wireless network, we recommend using a wired network.

❑ My Contents Selection Screen

To play a file, move to the file using the ◀/▶/▲/▼ buttons, and then press the **ENTER**  or  (Play) button. The TV plays the file. The **My Contents** screen may differ depending on how you accessed the screen or how files are sorted.

Information:

Displays the selected content category (Music, for example), device (USB drive, for example), folder/file name, page, and sort criteria.



File List Section:

Displays files or folders sorted by criteria you can select.

Content Category / Device name:

You can select the desired Content Category or Device.

Operation Buttons:

- **C** Yellow (**Edit Mode**): Lets you select music by checking the files you want to play. Only available in Music.
- **D** Blue (**Sorting**): Sorts files and folders by various criteria you can select. The criteria differ by content category.
- **◀▶** (**Page**): Move to next or previous page.
- **Tools**: Displays the option menu.
- **Return**: Move to the previous page or step.

■ Videos

Playing a Video

1. Press the ◀/▶/▲/▼ button to select the desired video in the file list.
2. Press the **ENTER** ↵ button or ▶ (Play) button.
 - The file name appears on the top with its playing time.
 - If video time information is unknown, playing time and the progress bar are not displayed.
 - You can use the ◀◀ (REW), ▶▶ (FF), Pause, Stop, and Play buttons on the bottom of your remote control during playback.



- During video playback, you can search using the ◀ and ▶ button.
- Press the **RETURN** button to exit the movie.

 In this mode, you can play movie clips contained in a game, but you cannot play the game itself.

 While a movie is playing, press the **TOOLS** button to access additional functions such as **Repeat Mode**, **Picture Size**, **Picture Mode**, and **Sound Mode**.

- Supported Video Subtitle Formats (for languages, etc.)

Name	File extension	Format
MPEG-4 time-based text	.ttxt	XML
SAMI	.smi	HTML
SubRip	.srt	string-based
SubViewer	.sub	string-based
Micro DVD	.sub or .txt	string-based

- Supported Video Formats

File Extention	Container	Video Codec	Resolution	Frame rate (fps)	Bit rate (Mbps)	Audio Codec
*.avi *.mkv	AVI MKV	DivX 3.11 / 4.x / 5.1 / 6.0	1920x1080	6 ~ 30	8	MP3 / AC3 / LPCM / ADPCM / DTS Core
		H.264 BP / MP / HP	1920x1080	6 ~ 30	25	
		MPEG4 SP / ASP	1920x1080	6 ~ 30	8	
		Motion JPEG	640x480	6 ~ 30	8	

File Extention	Container	Video Codec	Resolution	Frame rate (fps)	Bit rate (Mbps)	Audio Codec
*.asf	ASF	DivX 3.11 / 4.x / 5.1 / 6.0	1920x1080	6 ~ 30	8	MP3 / AC3 / LPCM / ADPCM / WMA
		H.264 BP/MP/HP	1920x1080	6 ~ 30	25	
		MPEG4 SP / ASP	1920x1080	6 ~ 30	8	
		Motion JPEG	640x480	6 ~ 30	8	
*.wmv	ASF	Window Media Video v9	1920x1080	6 ~ 30	25	WMA

File Extention	Container	Video Codec	Resolution	Frame rate (fps)	Bit rate (Mbps)	Audio Codec
*.mp4	MP4	H.264 BP / MP / HP	1920x1080	6 ~ 30	25	MP3 / ADPCM / AAC
		MPEG4 SP / ASP	1920x1080	6 ~ 30	8	
*.3gp	3GPP	H.264 BP / MP / HP	1920x1080	6 ~ 30	25	ADPCM / AAC / HE-AAC
		MPEG4 SP / ASP	1920x1080	6 ~ 30	8	
*.vro	VRO	MPEG1	1920x1080	24 / 25 / 30	30	AC3 / MPEG / LPCM
	VOB	MPEG2	1920x1080	24 / 25 / 30	30	

File Extention	Container	Video Codec	Resolution	Frame rate (fps)	Bit rate (Mbps)	Audio Codec
*.mpg *.mpeg	PS	MPEG1	1920x1080	24 / 25 / 30	30	AC3 / MPEG / LPCM / AAC
		MPEG2	1920x1080	24 / 25 / 30	30	
		H.264	1920x1080	6 ~ 30	25	
*.ts *.tp *.trp	TS	MPEG2	1920x1080	24 / 25 / 30	30	AC3 / AAC / MP3 / DD+ / HE-AAC
		H.264	1920x1080	6 ~ 30	25	
		VC1	1920x1080	6 ~ 30	25	

Other Restrictions

NOTE

- Video content will not play, or not play correctly, if there is an error in the content or the container.
- Sound or video may not work if the contents have a standard bit rate/frame rate above the compatible Frame/sec listed in the table above.
- If the Index Table is in error, the Seek (Jump) function is not supported.
- When you play a video through your network, it may not play, depending on the network status. When you play video over a network connection, the video may not be played smoothly. **for LCD 550 series**
- The menu may take longer to appear if the video's bit rate exceeds 10Mbps.

- Some USB/digital camera devices may not be compatible with the TV.
- Video content can not be played, if there are many contents in one file.

Video Decoder	Audio Decoder
<ul style="list-style-type: none">● Supports up to H.264, Level 4.1● H.264 FMO / ASO / RS, VC1 SP / MP / AP L4 and AVCHD are not supported.● For MPEG4 SP, and ASP :<ul style="list-style-type: none">– Below 1280 x 720: 60 frame max– Above 1280 x 720: 30 frame max● GMC is not support.	<ul style="list-style-type: none">● Supports up to WMA 7, 8, 9 STD, 9 PRO.● WMA Lossless, Voice Lossless, Voice is not supported.● The WMA sampling rate 22050Hz mono is not supported.

Playing movie continuously (Resume Play)





If you exit a movie when it is playing, you can play the movie later from the point where you stopped it.

1. Select the movie file you stopped and want to resume by pressing the ◀ or ▶ button.
 2. Press the ▶ (Play) or **ENTER** ↵ button.
 3. Press the **D** button to select **Play Continuously**(Resume Play).
The Movie will begin to play from where you stopped it.
- 📖 **Play Continuously**(Resume Play) is only available when you resume playing a movie you had stopped.





■ Music



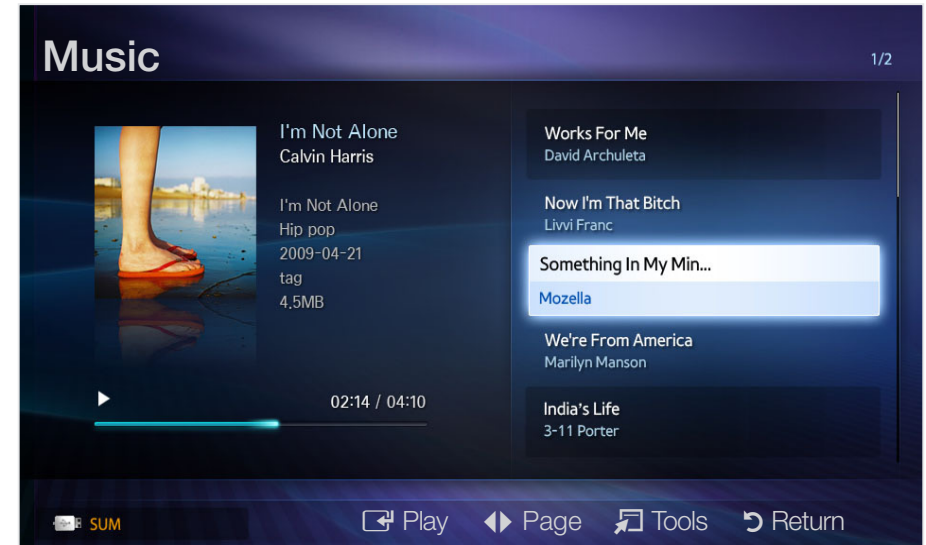

Playing Music

1. Press the ◀/▶/▲/▼ button to select the desired music file in the file list.
2. Press the **ENTER**  button or  (Play) button.
 - You can use the  (REW),  (FF), Pause, Stop, and Play buttons on the bottom of your remote control during playback.



-  While a music file is playing, press the **TOOLS** button to access additional functions such as **Repeat Mode** **Shuffle Mode** **Sound Mode**, and **Information**.
-  **My Contents** only displays files with MP3 file extensions. Other file extensions are not displayed, even if they are saved on the same USB device.
-  If the sound is abnormal when you play MP3 files, adjust the **Equalizer** in the **Sound** menu. (An over-modulated MP3 file may cause a sound problem.)

Playing selected music



1. Press the **C** (**Edit Mode**) button. A check box appears on the left side of all the music files.
2. Using the arrow keys, highlight a file you want to play, and then press **ENTER** .
 -  A check appears in the check box of the selected file.
3. Repeat for each file you want to play.
4. Press the **TOOLS** button, and then select **Play Selected Contents**.
 -  You can select or deselect all music by pressing the **Select All/Deselect All**. You can select or deselect a single file by pressing the **ENTER**  button.

■ Photos

Viewing a Photo (or Slide Show)

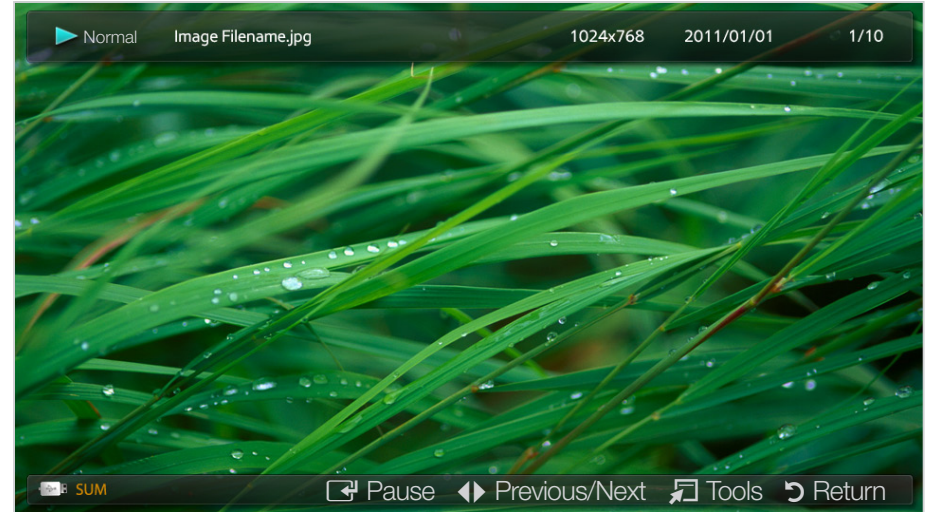
1. Press the ◀/▶/▲/▼ button to select the desired photo in the file list.
 2. Press the **ENTER** ↵ button.
 - To view files manually, one at a time, press the left or right arrow buttons.
 - To start the slide show, press the **ENTER** ↵ button when the file you selected is displayed.
 - During the slide show, all files in the file list are displayed in order.
- 📄 When you press the ▶ (Play) button in the file list, the slide show will start immediately.



-  During a **Slide Show**, press the **TOOLS** button to access additional functions such as **Slide Show Speed**, **Background Music**, **Zoom**, and **Rotate**.
-  You can add background music to a slide show if you have music files on your USB device or PC by setting **Background Music** to **On** in the **Tools** menu, and then selecting music files to play.
-  You can use the Pause, Stop, and Play buttons on the bottom of your remote control during a slide show.



☐ My Contents - Additional Functions

Sorting the file lists

Press the **D** button in the file list to sort the files. Checks indicate which media the sort criteria apply to.

Sort Criteria	Operation	Videos	Music	Photos
Folder View	Displays the whole folder. You can view a photo by selecting the folder.	✓	✓	✓
Title Search	Sorts and displays the file titles in Alphabet/Number/Symbol order.	✓	✓	✓
Latest Date	Sorts and shows files by the latest date.	✓		✓
Earliest Date	Sorts and shows files by the earliest date.	✓		✓

Sort Criteria	Operation	Videos	Music	Photos
Artist	Sorts music files by artist in alphabetical order.		✓	
Album	Sorts music file by album in alphabetical order.		✓	
Genre	Sorts music files by the genre.		✓	
Monthly	Sorts and shows photo files by month.			✓



Videos/Music/Photos Play Option menus

When playing a file, press the **TOOLS** button. Checks indicate which media the options apply to.

Option Name	Operation	Videos	Music	Photos
Title Search	You immediately load a video file you select.	✓		
Time Search	You can search a video at one minute intervals using the ◀ and ▶ buttons or by entering a location in minutes and seconds directly using your remote control.	✓		
Shuffle Mode	You can play music files randomly.		✓	
Repeat Mode	You can play movie and music files repeatedly.	✓	✓	

Option Name	Operation	Videos	Music	Photos
Picture Size	You can adjust the picture size to your preference.	✓		
Picture Mode	You can adjust the picture setting.	✓		✓
Sound Mode	You can adjust the sound setting.	✓	✓	✓
Subtitle Language	You can enjoy a video in a supported languages. The function is only enabled when stream-type files which support multiple audio formats are played.	✓		



Option Name	Operation	Videos	Music	Photos
Subtitle Setting	You can play a video with Subtitles. This function only works if the subtitle file has the same file name as the video file and the appropriate file extension. For example, Avatar.ttxt.	✓		
Start Slide Show / Pause Slide Show	You can start or pause a slide show.			✓
Slide Show Speed	You can select the slide show speed during the slide show.			✓
Background Music	You can turn background music on and off when watching a slide show.			✓

Option Name	Operation	Videos	Music	Photos
Background Music Setting	You can select background music when watching a Slide Show.			✓
Zoom	You can zoom into images in full screen mode. Use the ENTER  button to increase or decrease the zoom. Use the arrow buttons to select the area to enlarge.			✓
Rotate	You can rotate images in full screen mode. Use the left and right arrow buttons to rotate the picture. The rotation is only temporary.			✓
Information	You can see detailed information about the played file.	✓	✓	✓

What is Anynet+? **TOOLS**

Anynet+ is a function that enables you to control all connected Samsung devices that support Anynet+ with your Samsung TV's remote control. The Anynet+ system can be used only with Samsung devices that have the Anynet+ feature. To be sure your Samsung device has this feature, check if there is an Anynet+ logo on it.

NOTE

- You must connect an Anynet+ device using an HDMI cable. Some HDMI cables may not support Anynet+ functions.
- Anynet+ works when the AV device supporting Anynet+ is in the standby or on status.
- Anynet+ supports up to 12 AV devices in total. Note that you can connect up to 3 devices of the same type.
- However, you can connect only one receiver (home theater).

Anynet+ Menu

The Anynet+ menu changes depending on the type and status of the Anynet+ devices connected to the TV.

Anynet+ Menu	Description
View TV	Changes Anynet+ mode to TV broadcast mode.
Device List	Shows the Anynet+ device list.
(device_name) MENU	Shows the connected device menus. For example, if a DVD player is connected, the disc menu of the DVD player will appear.
(device_name) Tools	Shows the play menu of the connected device. For example, if a DVD player is connected, the play menu of the DVD player will appear.

Anynet+ Menu	Description
(device_name) Title Menu	Shows the title menu of the connected device. For example, if a DVD player is connected, the title menu of the movie in the DVD player will appear.  Depending on the device, this menu may not be available.
Receiver	Sound is played through the receiver.



❑ Setting Up Anynet+

 MENU  → System → Anynet+ (HDMI-CEC) → ENTER 

■ Anynet+ (HDMI-CEC)

Anynet+ (HDMI-CEC) (Off / On): To use the Anynet+ Function, you must set **Anynet+ (HDMI-CEC)** to **On**.





 When the **Anynet+ (HDMI-CEC)** function is disabled, all the Anynet+ related operations are deactivated.

Auto Turn Off (No / Yes): Set an Anynet+ Device to turn off automatically when the TV is turned off.

 If **Auto Turn Off** is set to **Yes**, running external devices will turn off at the same time as the TV turns off.

 **Auto Turn Off** may not be enabled depending on the device.

❑ Switching between Anynet+ Devices

1. Press the **TOOLS** button, select **Anynet+ (HDMI-CEC)**, and then press **ENTER** 
2. Select **Device List**, and then press the **ENTER**  button.
 -  If you cannot find a device you want, press the **A** button to refresh the list.
3. Select a device, and then press the **ENTER**  button. You can switch to the selected device.
 -  The **Device List** menu appears only when you set **Anynet+ (HDMI-CEC)** to **On** in the **System** menu.
 - Switching to the selected device may take up to 2 minutes. You cannot cancel the operation during the switching operation.
 - If you have selected an Anynet+ device by pressing the **SOURCE** button and then selecting its input source, you cannot use the Anynet+ function. You must select and switch to an Anynet+ device by using the **Device List** for Anynet+ to work.

❑ Listening through a Receiver

You can listen through a receiver (i.e Home Theater) instead of the TV speaker.

1. Select **Receiver** and set to **On**.

2. Press the **EXIT** button to exit.

- 📝 If your receiver supports audio only, it may not appear in the device list.
- 📝 The receiver will work when you have properly connected the optical in jack of the receiver to the DIGITAL AUDIO OUT (OPTICAL) jack of the TV.
- 📝 When the receiver (i.e Home Theater) is set to **On**, you can hear sound output from the TV's Optical jack. When the TV is displaying a DTV (air) signal, the TV will send out 5.1 channel sound to the receiver. When the source is a digital component such as a DVD and it is connected to the TV via HDMI, you will hear only 2 channel sound from the receiver.



NOTE

- You can only control Anynet+ devices using the TV remote control, not the buttons on the TV.
- The TV remote control may not work under certain conditions. If this occurs, reselect the Anynet+ device.
- The Anynet+ functions do not operate with other manufacturers' products.



❑ Troubleshooting for Anynet+

Problem	Possible Solution
Anynet+ does not work.	<ul style="list-style-type: none">● Check if the device is an Anynet+ device. The Anynet+ system supports Anynet+ devices only.● You can connect only one receiver (home theater) connected.● Check if the Anynet+ device power cord is properly connected.● Check the Anynet+ device's Video/Audio/HDMI cable connections.● Check whether Anynet+ (HDMI-CEC) is set to On in the System menu.

Problem	Possible Solution
Anynet+ does not work.	<ul style="list-style-type: none">● Check whether the TV remote control is in TV mode.● Check whether the remote control is Anynet+ compatible.● Anynet+ does not work in certain situations. (Searching channels, operating My Contents or Plug & Play (initial setup), etc.)● When connecting or removing the HDMI cable, please make sure to search devices again or turn your TV off and on again.● Check if the Anynet+ Function of Anynet+ device is set on.



Problem	Possible Solution
I want to start Anynet+.	<ul style="list-style-type: none">● Check if the Anynet+ device is properly connected to the TV and check if the Anynet+ (HDMI-CEC) is set to On in the System menu.● Press the TOOLS button to display the Anynet+ menu and select a menu you want.
I want to exit Anynet+.	<ul style="list-style-type: none">● Select View TV in the Anynet+ menu.● Press the SOURCE button on the TV remote control and select a device other than an Anynet+ device.● Press ▼ CH ▲ to change the TV mode. (Note that the channel button operates only when a tuner-embedded Anynet+ device is not connected.)

Problem	Possible Solution
The message ' Connecting to Anynet+ device... ' appears on the screen.	<ul style="list-style-type: none">● You cannot use the remote control when the TV is in the process of configuring Anynet+ or switching to a view mode.● Use the remote control after the TV has finished Anynet+ configuration or has finished switching to Anynet+.
The Anynet+ device does not play.	<ul style="list-style-type: none">● You cannot use the play function when Plug & Play (initial setup) is in progress.

Problem	Possible Solution
The connected device is not displayed.	<ul style="list-style-type: none">● Check whether or not the device supports Anynet+ functions.● Check whether or not the HDMI cable is properly connected.● Check whether Anynet+ (HDMI-CEC) is set to On in the System menu.● Search Anynet+ devices again.● You can connect an Anynet+ device using an HDMI cable only. Some HDMI cables may not support Anynet+ functions.● If Anynet+ is terminated because there has been a power failure or the HDMI cable has been disconnected, please repeat the device scan.
The TV sound is not output through the receiver.	<ul style="list-style-type: none">● Connect the optical cable between TV and the receiver.

About AllShare™ for LCD 550 series

AllShare™ connects your TV and compatible Samsung mobile phones / devices through a network. You can play media contents including videos, photos and music saved on your mobile phones or the other devices (such as your PC) by controlling them on the TV via the network.

-  For more information, visit “www.samsung.com” or contact the Samsung call center. Mobile devices may need additional software installation. For details, refer to each device’s user’s guide.
-  If your Samsung TV connects to a non-Samsung DLNA server, a compatibility issue may occur during video playback.

- 
- By connecting your Samsung TV to a network via AllShare™, you can use Samsung's original functions as follows:
- Playback of various video formats (DivX, MP4, 3GPP, AVI, ASF, MKV, etc.)
 - Video thumbnail feature
 - Bookmark function (to resume video playback)
 - Auto-chaptering (scene navigation)
 - Digital content management
 - Compatibility with various subtitle formats (SRT, SMI, SUB, TXT, TTXT)
 - Search with file names
 - And many others



To use the original DLNA functions of Samsung fully, it is recommended that you use the AllShare™ software provided with your TV.

❏ Setting Up AllShare™

🔑 MENU  → Network → AllShare Settings → ENTER 

■ AllShare Settings

- **Media (On / Off)**: Enables or disables the media function. When the media function is on, you can control Media contents play using mobile phones or other devices that support DLNA DMC.

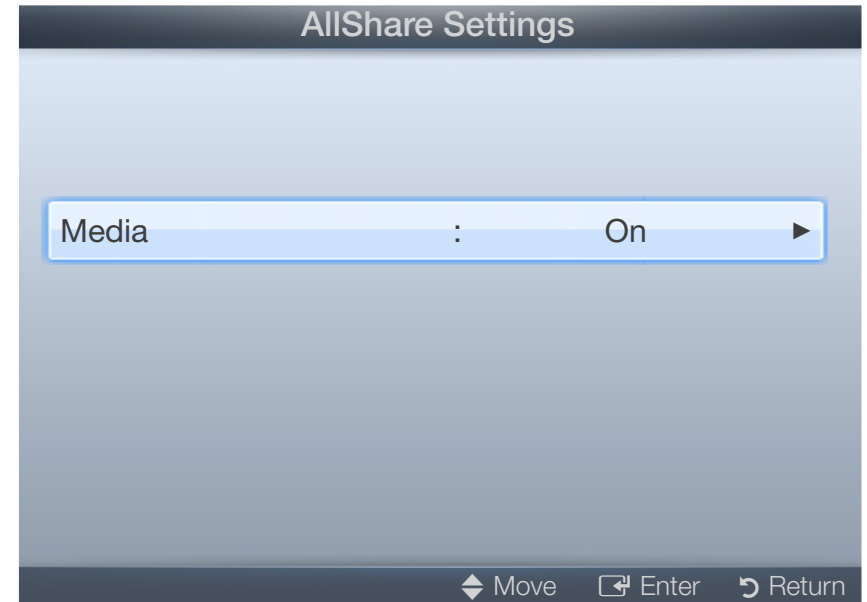

■ Media

Shows a list of mobile phones or connected devices which have been set up to use the **Media** function with this TV.

 The **Media** function is available in all devices which support DLNA DMC.



- **Allow / Deny**: Allows/Blocks the devices.
- **A Delete**: Deletes the devices from the list.

 This function only deletes the name of the devices from the list. If the deleted device is turned on or tries to connect to the TV, it may appear on the list again.

Using the Media Function

You can play media contents including videos, photos and music saved on your mobile phones or the other devices (such as your PC) by controlling them on the TV via the network.

NOTE

- To turn off the media contents transmission from the devices, set **Media** to **Off** in the **AllShare Settings**.
- Contents may not play on your TV depending on their resolution and format.
- The **ENTER**  and  /  buttons may not work depending on the type of media content.
- Using the devices, you can control the media playing. For details, refer to each device's user's guide.

❑ Troubleshooting

If the TV seems to have a problem, first review this list of problems and solutions. If none of these troubleshooting tips apply, visit samsung.com, then click on Support, or call Samsung customer service at 1-800-SAMSUNG.

Issues	Solutions and Explanations
Poor picture	<p>First, perform the Picture Test and to see if your TV is properly displaying the test image.</p> <ul style="list-style-type: none">● Go to MENU - Support - Self Diagnosis - Picture Test <p>If the test image is properly displayed, the poor picture may be caused by the source or signal.</p>

Issues	Solutions and Explanations
<p>The TV image does not look as good as it did in the store.</p>	<p>Store displays are typically tuned to digital, HD (high definition) channels.</p> <ul style="list-style-type: none">● If you have an analog cable/satellite box, upgrade to a digital set top box. Use HDMI or Component cables to deliver HD (high definition) picture quality.● Cable/Satellite subscribers: Try HD channels from the channel line up.● Air/Cable Antenna connection: Try HD channels after performing an Auto program.<ul style="list-style-type: none">☞ Many HD channels are up scaled from SD (Standard Definition) contents. Look for a channel that is broadcasting true HD content.● Adjust the Cable/Set top box video output resolution to 1080i or 720p.

Issues	Solutions and Explanations
The picture is distorted: macroblock error, small block, dots, pixelization.	<ul style="list-style-type: none">● The compression of video contents may cause picture distortion, especially in fast moving pictures such as sports and action movies.● A weak signal can cause picture distortion. This is not a TV problem.● Mobile phones used close to the TV (within 3.3 ft) may cause noise in the picture on analog and digital channels.
Color is wrong or missing.	<ul style="list-style-type: none">● If you're using a Component connection, make sure the component cables are connected to the correct jacks. Incorrect or loose connections may cause color problems or a blank screen.

Issues	Solutions and Explanations
<p>There is poor color or brightness.</p>	<ul style="list-style-type: none"> ● Adjust the Picture options in the TV menu. (go to Picture Mode / Color / Brightness / Sharpness) ● Adjust the Energy Saving option in the TV menu (go to MENU - System - Eco Solution - Energy Saving) ● Try resetting the picture to view the default picture setting. (go to MENU - Picture - Reset Picture)
<p>There is a dotted line on the edge of the screen.</p>	<ul style="list-style-type: none"> ● If the picture size is set to Screen Fit, change it to 16:9. ● Change the cable/satellite box resolution.
<p>The picture is black and white.</p>	<ul style="list-style-type: none"> ● If you are using an AV composite input, connect the video cable (yellow) to the Green jack of Component input 1 on the TV.

Issues	Solutions and Explanations
<p>When changing channels, the picture freezes or is distorted or delayed.</p>	<ul style="list-style-type: none"> ● If the TV is connected to a cable box, please try to reset the box. (Reconnect the AC cord and wait until the cable box reboots. It may take up to 20 minutes.) ● Set output resolution of the cable box to 1080i or 720p.
<p>Sound Problem</p>	<p>First, perform the Sound Test to determine if your TV audio is operating properly.</p> <ul style="list-style-type: none"> ● Go to MENU - Support - Self Diagnosis - Sound Test <p>If the audio is OK, the sound problem may be caused by the source or signal.</p>
<p>There is no sound or the sound is too low at maximum volume.</p>	<ul style="list-style-type: none"> ● Please check the volume of the device (Cable/Sat Box, DVD, Blu-ray, etc.) connected to your TV.

Issues	Solutions and Explanations
The picture is good but there is no sound.	<ul style="list-style-type: none">● Set the Speaker Select option to TV speaker in the Sound menu.● If you are using an external device, check the device's audio output option (Ex. You may need to change your cable box's audio option to HDMI if you have the box connected to your TV using an HDMI cable.).● If you are using a DVI to HDMI cable, a separate audio cable is required.● Reboot the connected device by reconnecting the device's power cable.

Issues	Solutions and Explanations
<p>The speakers are making an inappropriate noise.</p>	<ul style="list-style-type: none"> ● Check the cable connections. Make sure a video cable is not connected to an audio input. ● For Antenna or Cable connections, check the signal information. A weak signal may cause sound distortion. ● Perform the Sound Test as explained above.
<p>No Picture, No Video</p>	
<p>◀ The TV will not turn on.</p>	<ul style="list-style-type: none"> ● Make sure the AC power cord is securely plugged into the wall outlet and the TV. ● Make sure the wall outlet is working. ● Try pressing the POWER button on the TV to make sure the problem is not the remote control. If the TV turns on, refer to 'Remote control does not work' below. <p style="text-align: right;">▶</p>

Issues	Solutions and Explanations
<p>The TV turns off automatically.</p>	<ul style="list-style-type: none">● Ensure the Sleep Timer is set to Off in the System menu.● If your PC is connected to the TV, check your PC power settings.● Make sure the AC power cord is plugged in securely to the wall outlet and the TV.● When you are watching TV programs from an antenna, the TV will turn off after 10 - 15 minutes if there is no signal.

Issues	Solutions and Explanations
There is no picture/ video	<ul style="list-style-type: none">● Check the cable connections. (Remove and reconnect all cables connected to the TV and external devices).● Set your external device's (Cable/Sat Box, DVD, Blu-ray etc) video outputs to match the connections to the TV input. For example, if an external device's output is HDMI, it should be connected to an HDMI input on the TV.● Make sure your connected devices are powered on.● Be sure to select the TV's correct source by pressing the SOURCE button on the remote control.● Reboot the connected device by reconnecting the device's power cable.

Issues	Solutions and Explanations
RF(Cable/Antenna) Connection	
The TV is not receiving all channels.	<ul style="list-style-type: none">● Make sure the coaxial cable is connected securely.● Run Auto Program to add available channels to the channel list. Go to MENU - Channel - Auto Program then select Auto and make sure to select the correct Cable TV signal type. There are 3 options, STD HRC and IRC. Most cable systems use STD.● Verify the antenna is positioned correctly.
No Caption on digital channels.	<p>Check the Caption Setup menu. Try changing Caption Mode Service 1 to CC1.</p> <p>Some channels may not have caption data.</p>

Issues	Solutions and Explanations
<p>The picture is distorted: macroblock, error, small block, dots, pixelization.</p>	<ul style="list-style-type: none"> ● Compression of video contents may cause picture distortion. especially on fast moving pictures such as sports and action movies. ● A weak signal can cause picture distortion. This is not a TV problem.
<p>PC Connection</p>	
<p>A “Mode Not Supported” message appears.</p>	<ul style="list-style-type: none"> ● Set your PC’s output resolution so it matches the a resolution supported by the TV.
<p>“PC” is always shown on the source list, even if a PC is not connected.</p>	<ul style="list-style-type: none"> ● This is normal. “PC” is always shown in the source list, regardless of whether a PC is connected.

Issues	Solutions and Explanations
The video is OK but there is no audio.	<ul style="list-style-type: none">● If you are using an HDMI connection, check the audio output setting on your PC.

Network Connection **for LCD 550 series**

The wireless network connection failed.

- The Samsung Wireless USB dongle is required to use a wireless network.
- Make sure the network connection is set to **Wireless (General)**.
- Make sure the TV is connected to a wireless IP sharer (router).

Issues	Solutions and Explanations
Software Upgrade over the network fails.	<ul style="list-style-type: none">● Try Network Settings in the Network menu.● If you have latest SW version, SW upgrade will not proceed.
Others	
Purple/green rolling horizontal bars and buzzing noise from the TV speakers with Component cable connection.	<ul style="list-style-type: none">● Remove the left and right audio connections from the set-top-box. If the buzzing stops, this indicates that the set-top-box has a grounding issue. Replace the Component video cables with an HDMI connection.

Issues	Solutions and Explanations
The picture will not display in full screen.	<ul style="list-style-type: none">● HD channels will have black bars on either side of the screen when displaying up scaled SD (4:3) contents.● Black bars will appear on the top and bottom of the screen when you watch movies that have aspect ratios different from your TV.● Adjust the picture size option on your external device or change the TV to full screen.
The remote control does not work.	<ul style="list-style-type: none">● Replace the remote control batteries. Make sure you insert them with the plus and minus ends in the correct direction.● Clean the transmission window located on the top of the remote control.● Try pointing the remote control directly at the TV from 5~6 feet away.

Issues	Solutions and Explanations
<p>The cable/set top box remote control does not turn the TV on or off, or adjust the volume.</p>	<ul style="list-style-type: none"> ● Program the Cable/Set top box remote control to operate the TV. Refer to the Cable/Set top box user manual for the SAMSUNG TV code.
<p>A “Mode Not Supported” message appears.</p>	<ul style="list-style-type: none"> ● Check the supported resolution of the TV and adjust the external device’s output resolution accordingly. Refer to resolution settings in this manual.
<p>Caption on the TV menu is greyed out.</p>	<ul style="list-style-type: none"> ● You cannot select Caption in the TV menu when watching content from a device connected via HDMI or Component. ● Caption must be activated on the external device.

Issues	Solutions and Explanations
There is a plastic smell from the TV.	<ul style="list-style-type: none">● This smell is normal and will dissipate over time.
TV Signal Information is unavailable in the Self Diagnosis Test menu.	<ul style="list-style-type: none">● This function is only available for digital channels the TV receives from an Antenna / RF/Coax connection.
TV is tilted to the right or left side.	<ul style="list-style-type: none">● Remove the stand base from the TV and reassemble it.
The Channel menu is grey out (unavailable).	<ul style="list-style-type: none">● The Channel menu is only available when you select the TV source.



Issues	Solutions and Explanations
<p>Your settings are lost after 30 minutes or every time the TV is turned off.</p>	<ul style="list-style-type: none"> ● If TV is in the Store Demo mode, it will reset audio and picture settings every 30 minutes. Please change from Store Demo mode to Home Use mode using the Plug & Play procedure. Press the SOURCE button to select TV mode, go to MENU → System → Plug & Play → ENTER .
<p>You have intermittent loss of audio or video.</p>	<ul style="list-style-type: none"> ● Check the cable connections and reconnect them. ● Loss of audio or video can be caused by using overly rigid or thick cables. Make sure the cables are flexible enough for long term use. If mounting the TV to the wall, we recommend using cables with 90 degree connectors.

Issues	Solutions and Explanations
The PIP menu is not available.	<ul style="list-style-type: none">● PIP functionality is only available when you are using an HDMI, PC, or Component source.
You see small particles when you look closely at the edge of the frame of the TV.	<ul style="list-style-type: none">● This is part of the product's design and is not a defect.
POP (TV's internal banner ad) appears on the screen.	<ul style="list-style-type: none">● Select Home Use under Plug & Play mode. For details, refer to Plug & Play (Initial Setup).

❑ Anti-theft Kensington Lock

A Kensington Lock is a device you can use to physically fix your TV in place when using it in a public place. You wrap the Kensington Lock's cable around a large, immobile object and then attach the lock to the Kensington slot on the back of the TV.

The appearance and locking method may differ from the illustration below depending on the manufacturer. Refer to the manual provided with the Kensington Lock for additional information on proper use. The Kensington Lock is not supplied by Samsung.

- 📖 Please find a “” icon on the rear of the TV. The Kensington slot is beside the “” icon.
- 📖 The position and color may differ depending on the model.

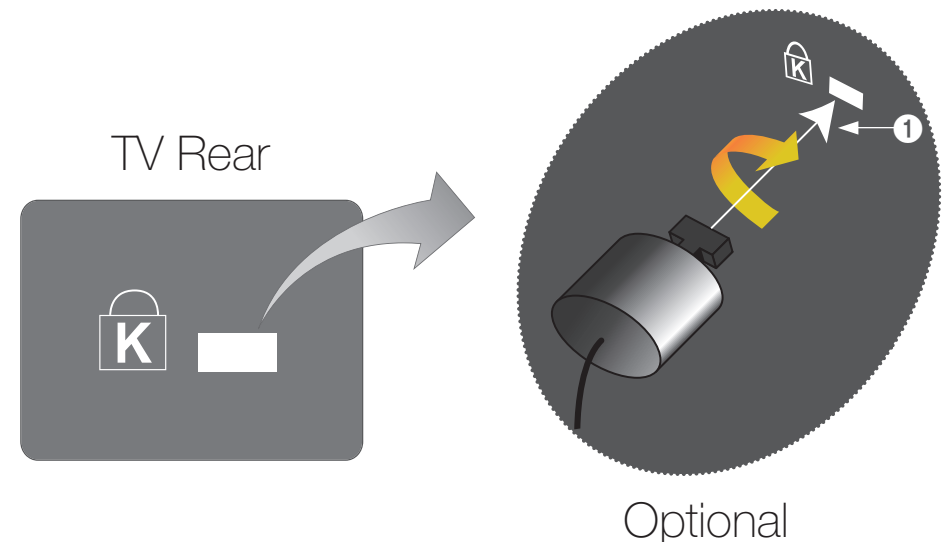

To lock the product, follow these steps:

1. Wrap the Kensington lock cable around a large, stationary object such as desk or chair.
2. Slide the end of the cable with the lock attached through the looped end of the Kensington lock cable.
3. Insert the locking device into the Kensington slot on the product.
4. Lock the lock.



NOTE

- These are general instructions. For exact instructions, see the User manual supplied with the locking device.
- The locking device has to be purchased separately.
- The location of the Kensington slot may be different depending on the TV model.

□ License



TheaterSound, SRS and  symbol are trademarks of SRS Labs, Inc. TheaterSound technology is incorporated under license from SRS Labs, Inc.

SRS TheaterSound™ provides the most immersive surround sound experience from front-facing speaker configurations, while maintaining steady volume and delivering rich bass and clear dialog.



Manufactured under license from Dolby Laboratories. Dolby and the double-D symbol are trademarks of Dolby Laboratories.



Manufactured under license under U.S. Patent #'s: 5,451,942; 5,956,674; 5,974,380; 5,978,762; 6,487,535 & other U.S. and worldwide patents issued & pending. DTS and the Symbol are registered trademarks, & DTS 2.0+ Digital Out and the DTS logos are trademarks of DTS, Inc. Product includes software. © DTS, Inc. All Rights Reserved.



DivX Certified® to play DivX® video up to HD 1080p, including premium content.

DivX®, DivX Certified® and associated logos are trademarks of DivX, Inc. and are used under license.

ABOUT DIVX VIDEO: DivX® is a digital video format created by DivX, Inc. This is an official DivX Certified® device that plays DivX video. Visit www.divx.com for more information and software tools to convert your files into DivX video.

ABOUT DIVX VIDEO-ON-DEMAND: This DivX Certified® device must be registered in order to play purchased DivX Video-on-Demand (VOD) movies. To obtain your registration code, locate the DivX VOD section in your device setup menu. Go to vod.divx.com for more information on how to complete your registration. Covered by one or more of the following U.S. patents : 7,295,673; 7,460,668; 7,515,710; 7,519,274

Open Source License Notice

In the case of using open source software, Open Source Licenses are available on the product menu. Open Source License Notice is written only English.