

## Video Cassette Recorder/ DVD Recorder

Operating Instructions \_\_\_\_\_ **US**

Manual de instrucciones \_\_\_\_\_ **ES**

RDR-VX560



# WARNING

To reduce the risk of fire or electric shock, do not expose this apparatus to rain or moisture.

To avoid electrical shock, do not open the cabinet. Refer servicing to qualified personnel only. The AC power cord must be changed only at a qualified service shop.

Batteries or batteries installed apparatus shall not be exposed to excessive heat such as sunshine, fire or the like.

## CAUTION

The use of optical instruments with this product will increase eye hazard. As the laser beam used in this DVD recorder is harmful to eyes, do not attempt to disassemble the cabinet. Refer servicing to qualified personnel only.

CAUTION: LASER RADIATION WHEN OPEN. Avoid direct exposure to the beam. To avoid eye injury, never stare into the beam, especially if it is reflected from surfaces. When servicing, disconnect the power supply from this product. The laser beam is controlled by a Class II laser safety system. Read the manual for more information. For more information on laser safety, contact the International Electrotechnical Commission (IEC) at www.iec.ch. For more information on laser safety, contact the American National Standards Institute (ANSI) at www.ansi.org. For more information on laser safety, contact the Canadian Standards Association (CSA) at www.csa.ca. For more information on laser safety, contact the British Standards Institution (BSI) at www.bsi.org.uk. For more information on laser safety, contact the Deutscher Normenausschuss (DIN) at www.din.de. For more information on laser safety, contact the European Committee for Standardization (CEN) at www.cen.eu. For more information on laser safety, contact the European Committee for Electrotechnical Standardization (CENELEC) at www.cenelec.eu. For more information on laser safety, contact the International Organization for Standardization (ISO) at www.iso.org. For more information on laser safety, contact the International Electrotechnical Commission (IEC) at www.iec.ch. For more information on laser safety, contact the American National Standards Institute (ANSI) at www.ansi.org. For more information on laser safety, contact the Canadian Standards Association (CSA) at www.csa.ca. For more information on laser safety, contact the British Standards Institution (BSI) at www.bsi.org.uk. For more information on laser safety, contact the Deutscher Normenausschuss (DIN) at www.din.de. For more information on laser safety, contact the European Committee for Standardization (CEN) at www.cen.eu. For more information on laser safety, contact the European Committee for Electrotechnical Standardization (CENELEC) at www.cenelec.eu. For more information on laser safety, contact the International Organization for Standardization (ISO) at www.iso.org.

This label is located on the laser protective housing inside the enclosure.

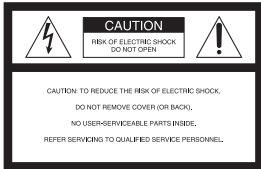

 This symbol is intended to alert the user to the presence of uninsulated "dangerous voltage" within the product's enclosure that may be of sufficient magnitude to constitute a risk of electric shock to persons.

 This symbol is intended to alert the user to the presence of important operating and maintenance (servicing) instructions in the literature accompanying the appliance.

## For customers in the U.S.A. Owner's Record

The model and serial numbers are located at the rear of the unit. Record the serial number in the space provided below. Refer to them whenever you call upon your Sony dealer regarding this product.  
Model No. RDR-VX560  
Serial No. \_\_\_\_\_

## CAUTION

You are cautioned that any change or modifications not expressly approved in this manual could void your authority to operate this equipment.

## Note

This equipment has been tested and found to comply with the limits for a Class B digital device, pursuant to Part 15 of the FCC Rules. These limits are designed to provide reasonable protection against harmful interference in a residential installation. This equipment generates, uses, and can radiate radio frequency energy and, if not installed and used in accordance with the instructions, may cause harmful interference to radio communications. However, there is no guarantee that interference will not occur in a particular installation. If this equipment does cause harmful interference to radio or television reception, which can be determined by turning the equipment off and on, the user is encouraged to try to correct the interference by one or more of the following measures:

- Reorient or relocate the receiving antenna.
- Increase the separation between the equipment and receiver.
- Connect the equipment into an outlet on a circuit different from that to which the receiver is connected.
- Consult the dealer or an experienced radio/TV technician for help.

# Precautions

## On safety

Should any solid object or liquid fall into the cabinet, unplug the recorder and have it checked by qualified personnel before operating it any further.

## On power sources

- Operate the recorder only on 120 V AC, 60 Hz.
- The recorder is not disconnected from the AC power source as long as it is connected to the wall outlet, even if the recorder itself has been turned off.
- Install this system so that the power cord can be unplugged from the wall socket immediately in the event of trouble.
- If you are not going to use the recorder for a long time, be sure to disconnect the recorder from the wall outlet. To disconnect the AC power cord, grasp the plug itself; never pull the cord.

## On placement

- Place the recorder in a location with adequate ventilation to prevent heat build-up in the recorder.
- If the recorder is brought directly from a cold to a warm location, or is placed in a very damp room, moisture may condense on the lenses inside the recorder and cause damage to the video head, tape, and the optical block. Should this occur, the recorder may not operate properly. When you first install the recorder, or when you move it from a cold to a warm location, remove the disc and tape and leave the recorder turned on for about three hours before operating the recorder.
- Do not place the recorder on a soft surface such as a rug that might block the ventilation holes.
- Do not place the recorder in a confined space such as a bookshelf or similar unit.

- Do not place the recorder in a location near heat sources, or in a place subject to direct sunlight, excessive dust, or mechanical shock.
- Do not place the recorder in an inclined position. It is designed to be operated in a horizontal position only.
- Keep the recorder, discs, and cassettes away from equipment with strong magnets, such as microwave ovens, or large loudspeakers.
- Do not place heavy objects on the recorder.
- To prevent fire or shock hazard, do not place objects filled with liquids, such as vases, on the apparatus.
- When you move the recorder, take out any discs. If you do not, the disc may be damaged.

### On recording

- Contents of the recording cannot be compensated for if the recording or playback is not made due to a malfunction of the recorder, disc, etc.
- Make trial recordings before making the actual recording.

### Copyrights

- Television programs, films, video tapes, discs, and other materials may be copyrighted. Unauthorized recording of such material may be contrary to the provisions of the copyright laws. Also, use of this recorder with cable television transmission may require authorization from the cable television transmitter and/or program owner.
- This product incorporates copyright protection technology that is protected by U.S. patents and other intellectual property rights. Use of this copyright protection technology must be authorized by Macrovision, and is intended for home and other limited viewing uses only unless otherwise authorized by Macrovision. Reverse engineering or disassembly is prohibited.

### Copy guard function

Since the recorder has a copy guard function, programs received through an external tuner (not supplied) may contain copy protection signals (copy guard function) and as such may not be recordable, depending on the type of signal.

#### IMPORTANT NOTICE

Caution: This recorder is capable of holding a still video image or on-screen display image on your television screen indefinitely. If you leave the still video image or on-screen display image displayed on your TV for an extended period of time you risk permanent damage to your television screen. Plasma display panels and projection televisions are especially susceptible to this.

If you have any questions or problems concerning your recorder, please consult your nearest Sony dealer.

### Important Safety Instructions

- 1) Read these instructions.
- 2) Keep these instructions.
- 3) Heed all warnings.
- 4) Follow all instructions.
- 5) Do not use this apparatus near water.
- 6) Clean only with dry cloth.
- 7) Do not block any ventilation openings. Install in accordance with the manufacturer's instructions.
- 8) Do not install near any heat sources such as radiators, heat registers, stoves, or other apparatus (including amplifiers) that produce heat.
- 9) Do not defeat the safety purpose of the polarized or grounding-type plug. A polarized plug has two blades with one wider than the other. A grounding type plug has two blades and a third grounding prong. The wide blade or the third prong are provided for your safety. If the provided plug does not fit into your outlet, consult an electrician for replacement of the obsolete outlet.

- 10) Protect the power cord from being walked on or pinched particularly at plugs, convenience receptacles, and the point where they exit from the apparatus.
- 11) Only use attachments/accessories specified by the manufacturer.
- 12) Use only with the cart, stand, tripod, bracket, or table specified by the manufacturer, or sold with the apparatus. When a cart is used, use caution when moving the cart/apparatus combination to avoid injury from tip-over.



- 13) Unplug this apparatus during lightning storms or when unused for long periods of time.
- 14) Refer all servicing to qualified service personnel. Servicing is required when the apparatus has been damaged in any way, such as power-supply cord or plug is damaged, liquid has been spilled or objects have fallen into the apparatus, the apparatus has been exposed to rain or moisture, does not operate normally, or has been dropped.

## About this manual

- Instructions in this manual describe the controls on the remote. You can also use the controls on the recorder if they have the same or similar names as those on the remote.
- The on-screen display illustrations used in this manual may not match the graphics displayed on your TV screen.
- The explanations regarding discs in this manual refer to discs created on this recorder. The explanations do not apply to discs that are created on other recorders and played back on this recorder.
- Icons, such as **DVD** or **VHS**, listed at the top of each explanation indicate what kind of media can be used with the function being explained. For details about usable discs, see “Quick Guide to Disc Types” on page 30.

# Table of Contents

WARNING	2
Precautions	2
What is a Video Cassette Recorder/DVD Recorder?	8
How to Use the On-Screen Menus	10

---

<b>Hookups and Settings</b>	<b>12</b>
Hooking Up the Recorder	12
Step 1: Unpacking	12
Step 2: Connecting the Cable Box/Satellite Receiver (Tuner)	12
Step 3: Connecting to Your TV	15
Step 4: Connecting to Your AV Amplifier (Receiver)	18
Step 5: Connecting the Power Cord	20
Step 6: Preparing the Remote	20
Step 7: Easy Setup	23
Connecting Another VCR or Similar Device	27

---

<b>Quick Guide to Disc Types</b>	<b>30</b>
Recordable and Playable Discs	30
Playable Discs	32

## DVD Operation

---

<b>DVD/USB Playback</b>	<b>34</b>
Playing Discs	34
Playback Options	35
Playing a Title From the Title List	38
Searching for a Title/Chapter/Track, etc.	39
Displaying the Playing Time and Play Information	40
Playing MP3 Audio Tracks and JPEG Image Files on the Disc	41
Playing From a Connected USB Device	45

---

<b>DVD Recording</b>	<b>47</b>
Before Recording	47
DVD Recording From Connected Equipment Without the Timer	49
DVD Timer Recording From Connected Equipment	51
Changing or Canceling DVD Timer Settings (Timer List)	53
Recording From Connected Equipment With a Timer (Synchro Rec)	54
Recording From Another VCR or Similar Device	56

---

<b>DVD Editing</b>	<b>57</b>
Before Editing	57
Editing a Title	58
Changing the Name of a Title	61
Creating a Playlist	62
Formatting/Renaming/Protecting a Disc	64
Finalizing a Disc (Preparing a Disc for Playback on Other Equipment)	66

## VCR Operation

---

<b>VCR Playback</b> .....	<b>68</b>
Playing a VHS Tape .....	68
Playback Options .....	70
Searching Using Various Functions .....	71
Displaying the Playing Time and Play Information .....	72
Selecting the Sound During Playback .....	73

---

<b>VCR Recording</b> .....	<b>74</b>
Before Recording .....	74
VCR Recording From Connected Equipment Without the Timer .....	75
VCR Timer Recording From Connected Equipment .....	77
Changing or Canceling VCR Timer Settings (Timer List) .....	79
Recording From Connected Equipment With a Timer (Synchro Rec) .....	80
Recording From Another VCR or Similar Device .....	82

---

<b>Dubbing (TAPE ↔ DVD)</b> .....	<b>83</b>
Dubbing From a VHS Tape to a DVD .....	83
Dubbing From a DVD to a VHS Tape .....	84

---

<b>DV/D8 Dubbing (DV/D8 → DVD)</b> .....	<b>86</b>
Before DV/D8 Dubbing .....	86
Connecting a DV Camcorder to the DV IN Jack .....	86
Dubbing From a DV/D8 Format Tape to a DVD .....	87

---

<b>USB Dubbing (USB → DVD)</b> .....	<b>89</b>
Before USB Dubbing .....	89
Connecting to the USB jack .....	89
Dubbing From a DVD Camcorder (DVD Backup) .....	90
Dubbing From a HDD Camcorder (Program Dubbing) .....	91
Copying JPEG Image Files From a Connected Digital Still Camera .....	93

---

<b>Settings and Adjustments</b> .....	<b>96</b>
Using the Setup Displays .....	96
Clock Setting (Clock Set) .....	97
Video Settings (Video) .....	98
Audio Settings (Audio) .....	100
Recording, VCR, Set Top Box, Control for HDMI Settings (Features) .....	102
Language, Parental Control Settings/Factory Settings (Options) .....	104
Easy Setup (Resetting the Recorder) .....	106

---

<b>Additional Information</b> .....	<b>107</b>
Troubleshooting .....	107
Notes About This Recorder .....	112
Specifications .....	113
About i.LINK .....	115
Guide to Parts and Controls .....	116
DVD Audio/Subtitle Language .....	120
Cable Box/Satellite Receiver Brand Code .....	121
Index .....	126

# What is a Video Cassette Recorder/DVD Recorder?

This is a DVD recorder with built-in VHS video deck, and allows recording/playback of DVD discs and VHS tapes. DVD editing is also possible.

## Recording and timer recording

Record TV programs on a DVD or VHS tape, either manually or using the timer. You need to connect a tuner such as a cable box to this recorder.

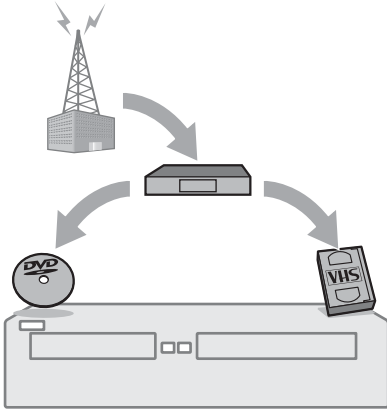

## One Touch Dubbing (DVD ↔ VHS)

Dub in either direction between a DVD disc and VHS tape with the simple press of a button. Note that copy-protected signals will not be recorded.

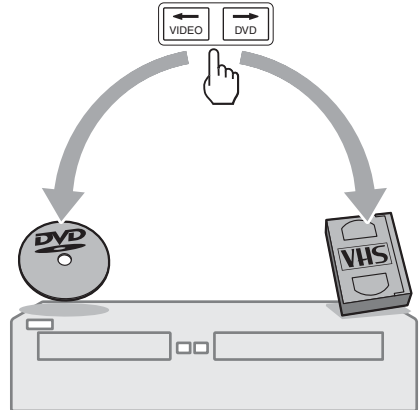

## Easy selection between DVD and VCR

Simply press the DVD or VIDEO button to select the media format you want to use.

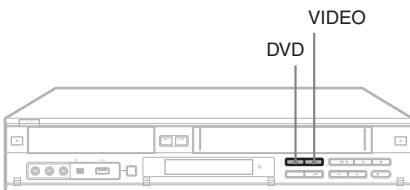
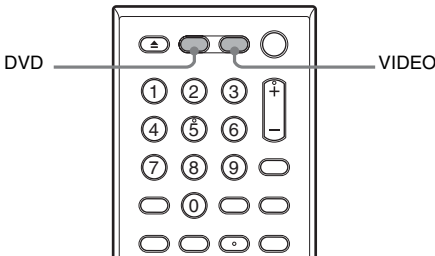

## Control your cable box or satellite receiver – Set top box control

Connect the supplied set top box controller to have the recorder change the channel of your cable box or satellite receiver (page 12).

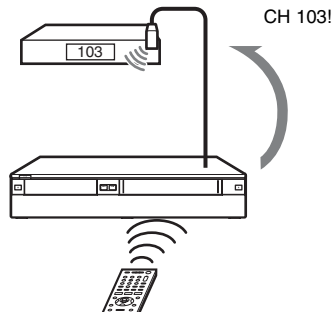



## Quick access to recorded titles – Title List

Display the Title List to view all titles on a disc and select a title for playback or editing.

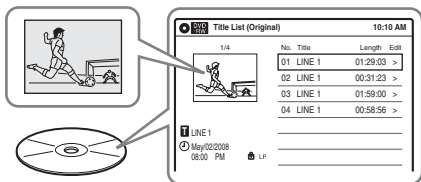

## Dubbing (DV/USB → DVD)

Connect your DV camcorder or USB device to the recorder to dub video or photo contents to a DVD.

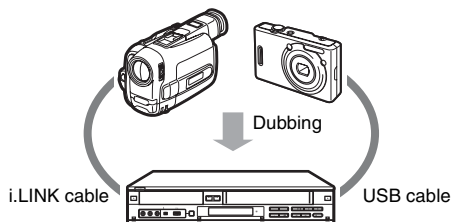

## Creating your own program – Playlist

Record a program on a DVD-RW (VR mode) or DVD-R (VR mode), then erase, move or add scenes as you like without changing the original contents.

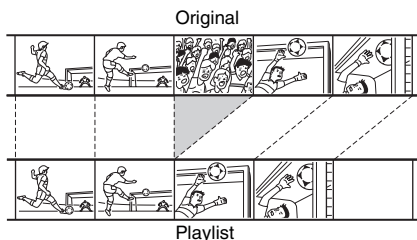

## Operation restrictions

Current Operation	Possible Simultaneous Operations			
	VCR Playback	VCR Recording	DVD Playback	DVD Recording
Playing a VHS tape <sup>*1</sup>	—	No	No	Yes
Recording on a VHS tape	No	—	Yes	Yes <sup>*3</sup>
Playing a DVD <sup>*2</sup>	No	Yes	—	No
Recording on a DVD	Yes	Yes <sup>*3</sup>	No	—

<sup>\*1</sup> When pressing DVD, VCR playback stops.

<sup>\*2</sup> When pressing VIDEO, DVD playback stops.

<sup>\*3</sup> Only for timer recording. You can also record from LINE1 and LINE2 at the same time.

# How to Use the On-Screen Menus

The following three displays are mainly used to operate this recorder. Once you become familiar with the basic operations, you will find the recorder easy to use.

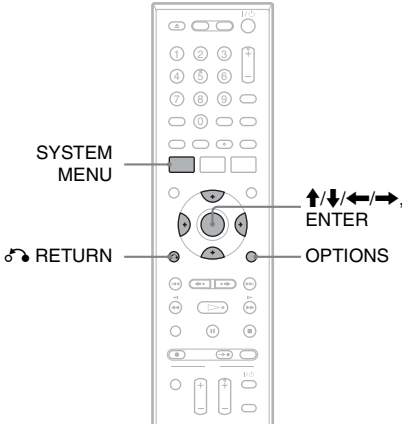

## System Menu

The System Menu appears when you press SYSTEM MENU, and provides entries to all of the recorder's main functions, such as timer recording and setup.

Selectable options on the System Menu differ depending on the media type, disc condition, and operating status.

Select an option by pressing **↑/↓** and ENTER.

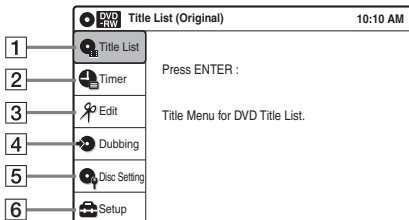

### 1 "Title List"

Displays the list of the disc contents, including the recording information and movie thumbnail image, which allows you to select a title to play or edit.

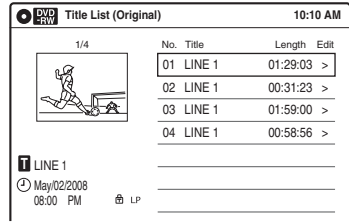

### 2 "Timer"

Used to set a new timer recording for a disc or VHS tape, as well as change or cancel the timer recordings you set.

### 3 "Edit"

Used to create or edit a Playlist (unfinalized DVD-RWs (VR mode)/DVD-Rs (VR mode) only).

### 4 "Dubbing"

Used to dub from a disc to a VHS tape and vice versa, and also dub from a DV/D8 format tape or a USB device to a disc.

### 5 "Disc Setting"

Used to rename, protect, format, or finalize a disc, or erase all titles on the disc. Also, displays the disc information.

### 6 "Setup"

Displays the "Setup" display for setting up the recorder to suit your preferences.

## Sub-menu

The sub-menu appears when you select an item from a list menu (e.g., a title from the Title List menu), and press ENTER. The sub-menu displays options applicable only to the selected item. The displayed options differ depending on the situation and disc type.

Select an option by pressing **↑/↓** and ENTER.

Example: The Title List menu

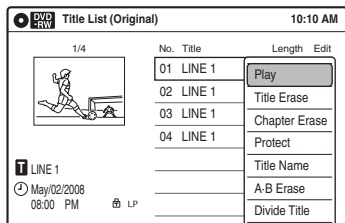

Options for the selected item

## OPTIONS

The OPTIONS menu appears when you press OPTIONS. You can search for a title/chapter/track, check the playing and remaining time, or change settings for audio/angle/subtitle. The displayed options differ depending on the media type.

Press **↑/↓** to select an option, press **←/→** to select the desired item, and press ENTER.

Example: When you press OPTIONS while a DVD VIDEO is playing.

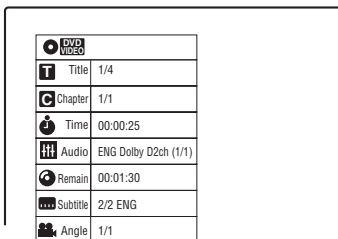

### To return to the previous display

Press **↶** RETURN.

### Notes

- The OPTIONS menu settings cannot be changed during DVD recording.
- The System Menu does not appear when recording on a DVD, or dubbing from VHS tape to a DVD.
- You cannot use the DVD or VIDEO buttons with the System Menu turned on.

### Hooking Up the Recorder

Follow steps 1 to 7 to hook up and adjust the settings of the recorder.

#### Notes

- Plug cords securely to prevent unwanted noise.
- See the instructions supplied with the components to be connected.
- You cannot connect this recorder to a TV that does not have a video input jack.
- Be sure to disconnect the power cord of each component before connecting. Do not connect the power cord until you reach “Connecting the Power Cord” on page 20.

### Step 1: Unpacking

Check that you have the following items:

- Audio/video cord  
(phono plug × 3 ↔ phono plug × 3) (1)
- Remote commander (remote) (1)
- Set top box controller (1)
- Size AA (R6) batteries (2)

### Step 2: Connecting the Cable Box/Satellite Receiver (Tuner)

This recorder does not include a TV tuner.

To record TV programs on this recorder, you need to connect the recorder to a tuner that has audio/video output jacks.

If you have been using your VCR connected to an antenna, connect this recorder to your VCR using an audio/video cord. In this way, you will be able to record TV programs.

You cannot record on this recorder if you have:

- a cable box or satellite receiver without audio/video outputs.
- cable with no cable box.
- antenna only (no cable TV).

In the cases above, contact your cable service or satellite service company to see if they can provide you with a compatible cable box or satellite receiver.

#### Using the cable box/satellite receiver control function

This function allows the recorder to control a cable box or satellite receiver via the supplied set top box controller. You can also use the recorder’s remote control to change channels on the cable box/satellite receiver whenever the cable box/satellite receiver and the recorder are turned on. To use the cable box/satellite receiver control function, you need to:

- Check the brand code of your cable box/satellite receiver. See “Cable Box/Satellite Receiver Brand Code” (page 121).
- Connect the set top box controller (page 13).
- Set the brand code number and the recorder’s input that is connected to the cable box/satellite receiver (page 23).

After setting up the cable box/satellite receiver control, check that the recorder can correctly control the cable box or satellite receiver (page 25).

## Connecting a cable box/satellite receiver and set top box controller

Connect the LINE 1 IN jacks using an audio/video cord.

With this hookup, you can record any channel on the cable box or satellite receiver. Be sure that the cable box or satellite receiver is turned on. You need to connect to the LINE 1 IN (VIDEO/AUDIO) jacks for the Synchro-Rec function (pages 54 and 80).

To record cable or satellite programs, you need to match the input source on the recorder (LINE1) to the input jack connected to the cable box or satellite receiver (LINE 1 IN).

Place the set top box controller near the remote sensor on the cable box/satellite receiver.

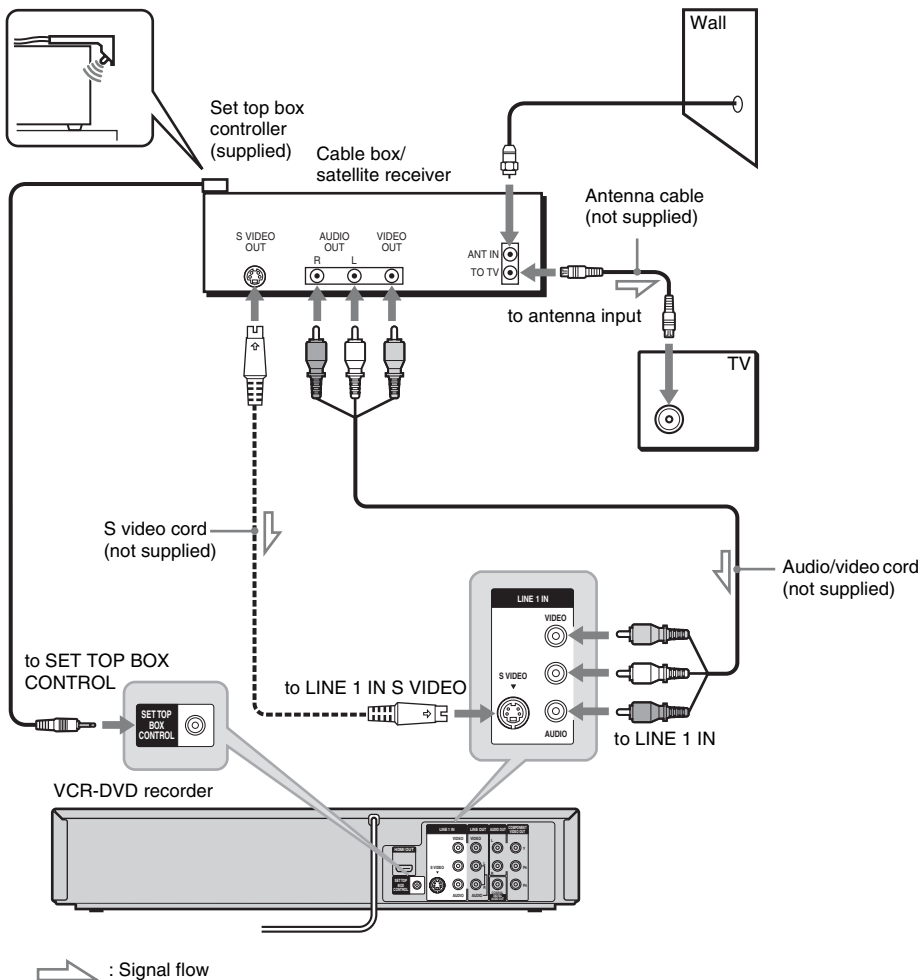

### To use an S video cord for enjoying higher quality images

Connect the LINE 1 IN S VIDEO jack using an S video cord (not supplied) instead of the yellow (video) plug of the audio/video cord. Leave the audio plugs connected to the AUDIO L/R jacks. When using this connection, be sure to set "Line1 Input" to "S-Video" in the "Video" setup (page 99).

You cannot use the Synchro-Rec function with this connection.

### **Hint**

You can also connect a cable box/satellite receiver to the LINE 2 IN jacks on the front panel. In this case, select “Line2” for “Connections” of “Set Top Box Control” in the “Features” setup (page 103).

### **Notes**

- Do not connect to the S VIDEO and yellow VIDEO jacks at the same time.
- Synchro-Recording does not work with some tuners. For details, see the tuner’s operating instructions.

## Step 3: Connecting to Your TV

Connect the supplied audio/video cord to the LINE OUT (VIDEO/AUDIO L/R) jacks of the recorder. If your TV has an HDMI jack, or component video input jacks, see page 16 or 17.

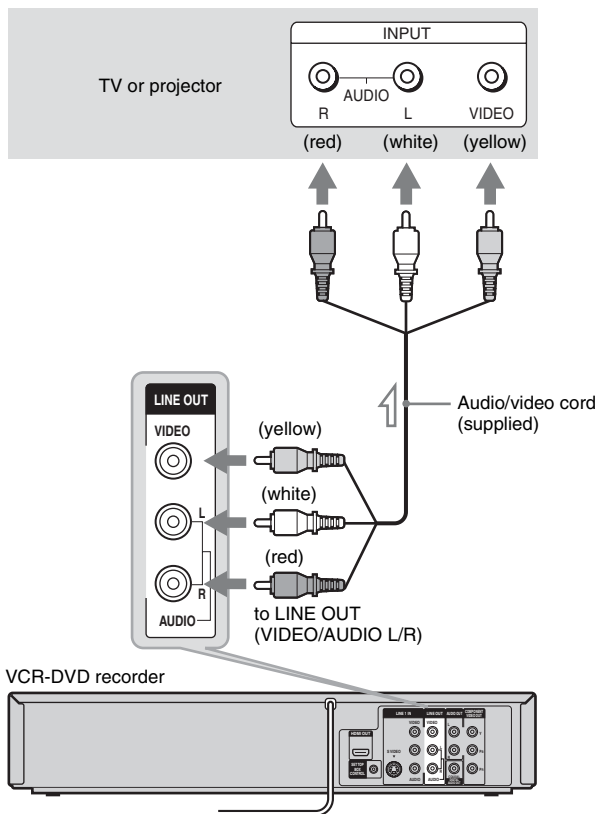

### When playing “wide screen” images

Some recorded images may not fit your TV screen. To change the picture size, see page 98.

#### Note

Do not connect your TV’s audio output jacks to the LINE IN (AUDIO L/R) jacks at the same time. This will cause unwanted noise to come from your TV’s speakers.

## If your TV has an HDMI input jack

Connect the HDMI\* OUT jack using a certified Sony HDMI cord (not supplied). You will enjoy high quality picture and sound. If your TV accepts progressive 1080p format signals, you must use this connection. The HDMI indicator is lit in the front panel display when the recorder outputs signals through the HDMI OUT jack.

Be sure to turn off the recorder before connecting an HDMI cord.

\* This DVD recorder incorporates High-Definition Multimedia Interface (HDMI™) technology. HDMI, the HDMI Logo and High-Definition Multimedia Interface are trademarks or registered trademarks of HDMI Licensing LLC.

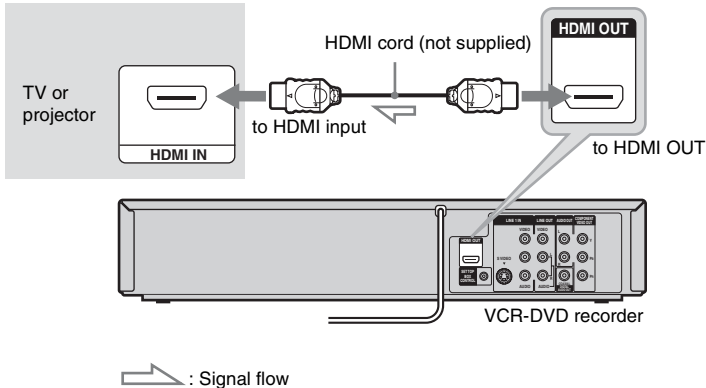

## Using the Control for HDMI functions for 'BRAVIA' Sync (for HDMI connections only)

By connecting Sony components that are compatible with the Control for HDMI function with an HDMI cord (not supplied), operation is simplified as below:

- One-Touch Play (page 38)
- System Power-Off

When you turn the TV off by using the  button on the TV's remote, the components compatible with the Control for HDMI function turn off automatically.

### To prepare for the 'BRAVIA' Sync features

Set "Control for HDMI" to "On" in the "Features" setup (page 104). For details on TV settings, refer to the operating instructions supplied with the TV.

### Notes

- You cannot connect the HDMI OUT jack to DVI jacks that are not HDCP compliant (e.g., DVI jacks on PC displays).
- During DVD recording, you cannot watch VHS pictures by pressing VIDEO, as the HDMI OUT jack will output DVD video signals only.
- Depending on the connected component, the Control for HDMI function may not work. Refer to the operating instructions supplied with the component.
- The recorder supports only the playback option of Control for HDMI. "Player" appears on the TV screen when using the Control for HDMI functions.



## If your TV has component video input jacks

Connect the COMPONENT VIDEO OUT jacks using a component video cord (not supplied) or three video cords (not supplied) of the same kind and length. You will enjoy accurate color reproduction and high quality images.

If your TV accepts progressive 480p format signals, you must use this connection and then set “Progressive” of “Video” to “On” in the “Setup” display (page 99).

When using this connection, be sure to connect the audio cord to the LINE OUT (AUDIO L/R) jacks.

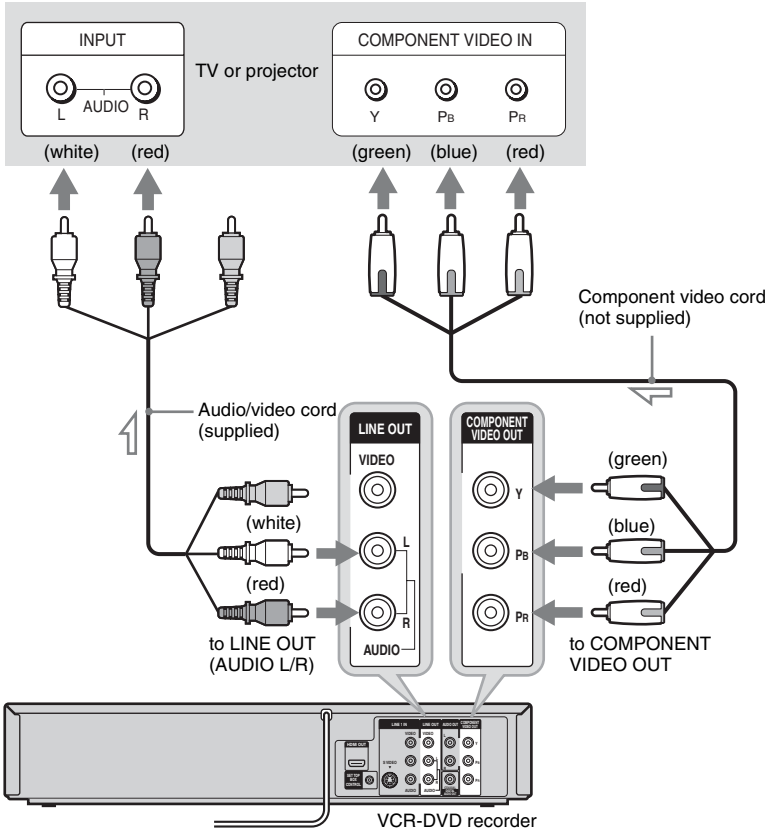

: Signal flow

### Note

During DVD recording, you cannot watch VHS pictures by pressing VIDEO, as the COMPONENT VIDEO OUT jacks will output DVD video signals only.

# Step 4: Connecting to Your AV Amplifier (Receiver)

Select one of the following patterns **A** or **B**, according to the input jack on your AV amplifier (receiver). This will enable you to listen to sound through your AV amplifier (receiver).

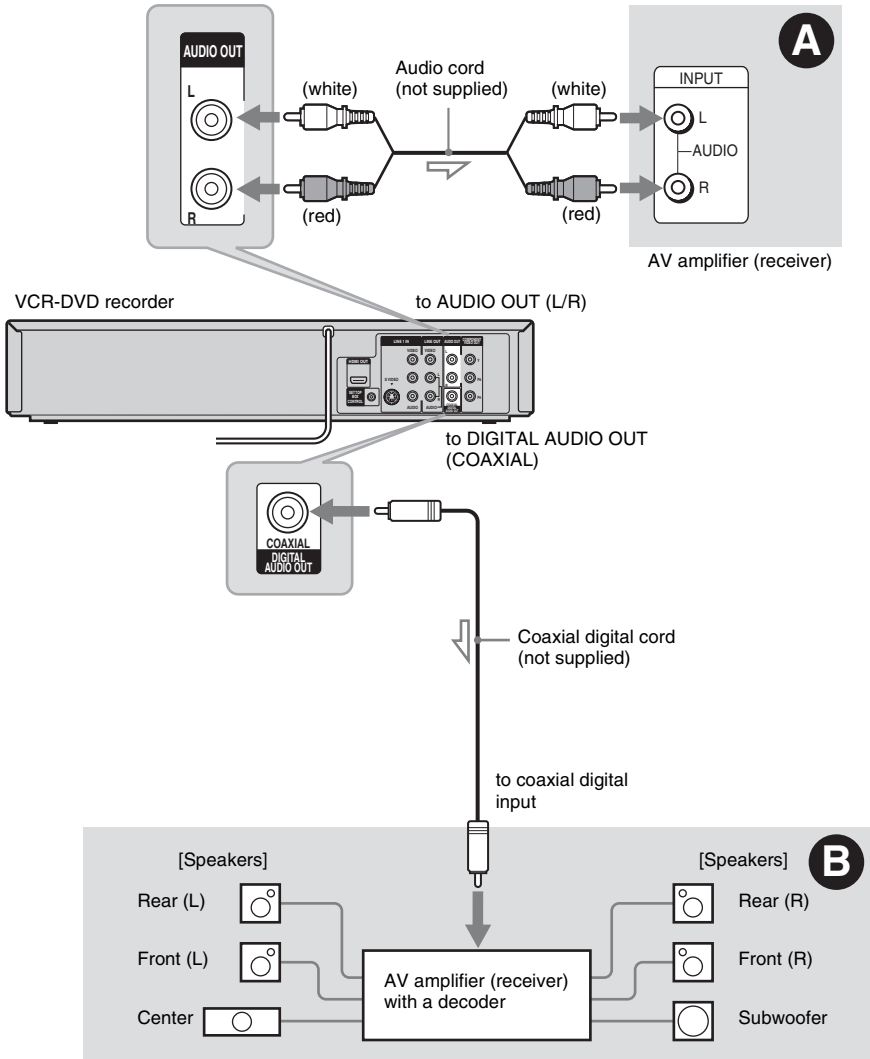

: Signal flow

### A Connecting to audio L/R jacks

This connection uses a stereo amplifier's (receiver's) two front speakers for sound.

You can enjoy the surround function that creates virtual speakers from two stereo speakers. Select "Surround1," "Surround2," or "Surround3" in "Surround" of the "Audio" setup (page 101).

#### Surround 1

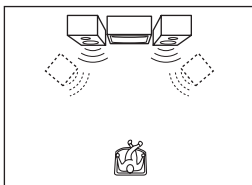

#### Surround 2

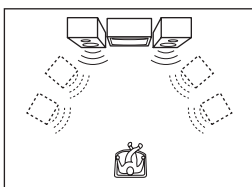

#### Surround 3

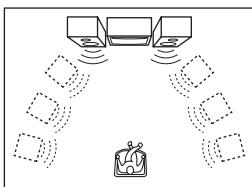

 Virtual speaker

### Note

Make sure that your listening position is between and at an equal distance from your speakers, and that the speakers are located in similar surroundings.

### B Connecting to a digital audio input jack

Use this connection if your AV amplifier (receiver) has a Dolby<sup>\*1</sup> Digital or DTS<sup>\*2</sup> decoder and a digital input jack. You can enjoy the surround effect of Dolby Digital (5.1ch) or DTS (5.1ch).

After you have completed the connection, make the appropriate settings under the "Audio" setup (page 100). Otherwise, no sound or a loud noise will come from your speakers.

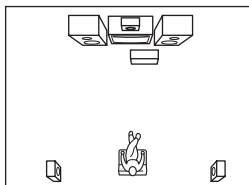

\*1 Manufactured under license from Dolby Laboratories. "Dolby" and the double-D symbol are trademarks of Dolby Laboratories.

\*2 Manufactured under license under U.S. Patent #: 5,451,942 & other U.S. and worldwide patents issued & pending. DTS and DTS Digital Out are registered trademarks and the DTS logos and Symbol are trademarks of DTS, Inc. © 1996-2007 DTS, Inc. All Rights Reserved.

### Hints

- For correct speaker location, see the operating instructions supplied with the connected components.
- With a coaxial digital connection, you cannot:
  - use the virtual surround effects of this recorder.
  - switch the bilingual sounds on a DVD-RW/DVD-R (VR mode) by pressing AUDIO when you set "Dolby Digital" to "Dolby Digital" in the "Audio" setup (page 100).

### Note

During DVD recording, the DIGITAL AUDIO OUT jack outputs DVD audio signals only. You cannot hear VHS sound by pressing VIDEO.

## Step 5: Connecting the Power Cord

Plug the recorder and TV power cords into an AC outlet. After you connect the power cord, **you must wait for a short while before operating the recorder.** You can operate the recorder only after the front panel display lights up and the recorder enters standby mode.

If you connect additional equipment to this recorder (page 27), be sure to connect the power cord only after all connections are complete.

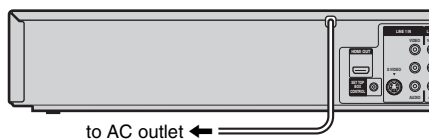

## Step 6: Preparing the Remote

You can control the recorder using the supplied remote.

Insert two size AA (R6) batteries by matching the ⊕ and ⊖ ends on the batteries to the markings inside the battery compartment. Be sure to close the battery cover properly. When using the remote, point it at the remote sensor  on the recorder.

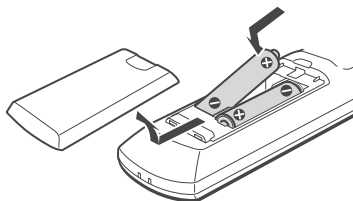

### Notes

- If the supplied remote interferes your other Sony DVD recorder or player, change the command mode number for this recorder (page 22).
- Use the batteries correctly to avoid possible leakage and corrosion. Do not touch the liquid with bare hands should leakage occur. Observe the following:
  - Do not use a new battery with an old battery, or batteries of different manufacturers.
  - Do not attempt to recharge the batteries.
  - If you do not intend to use the remote for an extended period of time, remove the batteries.
  - If battery leakage occurs, wipe out any liquid inside the battery compartment, and insert new batteries.
- Do not expose the remote sensor (marked  on the front panel) to strong light, such as direct sunlight or lighting apparatus. The recorder may not respond to the remote.
- With normal use, the batteries should last about three to six months.
- Do not leave the remote in an extremely hot or humid place.
- Do not drop any foreign object into the remote casing, particularly when replacing the batteries.

## Controlling TVs with the remote

You can adjust the remote control's signal to control your TV.

### Notes

- Depending on the TV, some or all of the buttons below may not work for the TV.
- If you enter a new code number, the code number previously entered will be erased.
- When you replace the batteries of the remote, the code number may be reset to the default setting. Set the appropriate code number again.

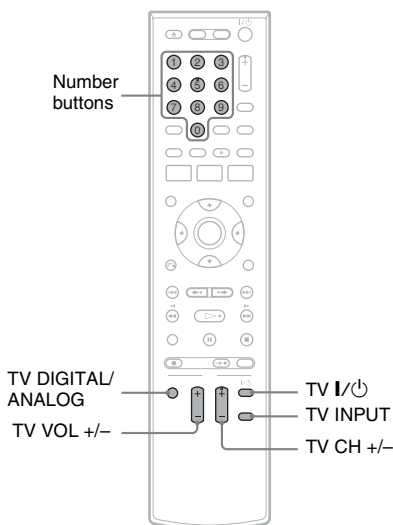

**1** Hold down **TV I/Power** located at the bottom of the remote.

Do not press **I/Power** at the top of the remote.

**2** With **TV I/Power** pressed down, enter your TV's manufacturer code (see below) using the number buttons.

**3** Release **TV I/Power**.

The following buttons are for TV.

Press	To
TV I/Power	Turn your TV on or off
TV VOL +/-	Adjust the volume of your TV
TV CH +/-	Select the channel on your TV

TV INPUT	Switch your TV's input source
TV DIGITAL/ANALOG	Select the broadcast on a Sony TV that can switch between digital and analog

### Code numbers of controllable TVs

If more than one code number is listed, try entering them one at a time until you find the one that works with your TV.

Manufacturer	Code number
Sony	01 (default)
Akai	04
AOC	04
Centurion	12
Coronado	03
Curtis-Mathes	12, 14
Daewoo	04, 22
Daytron	03, 12
Fisher	11
General Electric	04, 06, 10
Hitachi	02, 03, 04
J.C.Penney	04, 10, 12
JVC	09
KMC	03
LG/Gold Star	03, 04, 17
Magnavox	03, 04, 08, 12, 21
Marantz	04, 13
MGA/Mitsubishi	04, 12, 13, 17
NEC	04, 12
Panasonic	06, 19
Philco	02, 03, 04, 08
Philips	08, 21
Pioneer	06, 16
Portland	03
Proscan	10
Quasar	06, 18
Radio Shack	05, 10, 14
RCA	04, 10

Manufacturer	Code number
Sampo	12
Samsung	03, 04, 12, 20
Sanyo	11, 14
Scott	12
Sears	07, 10, 11
Sharp	03, 05, 18
Sylvania	08, 12
Teknika	03, 08, 14
Toshiba	07, 18
Wards	03, 04, 12
Yorx	12
Zenith	14, 15

## If you have a Sony DVD player or more than one Sony DVD recorder

If the supplied remote interferes with your other Sony DVD recorder or player, set the command mode number for this recorder and the supplied remote to one that differs from the other Sony DVD recorder or player, after you have completed “Step 7: Easy Setup.”

The default command mode setting for this recorder and the supplied remote is DVD 3.

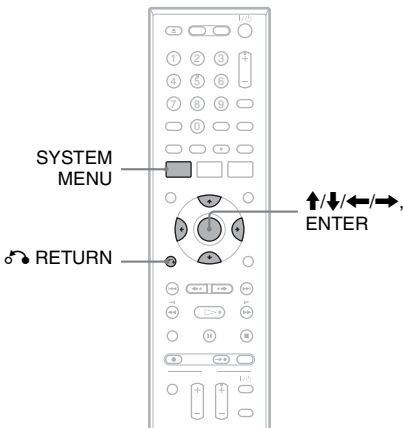

- 1 Check that Easy Setup (page 23) has been finished. If Easy Setup has not been finished, first perform Easy Setup.

- 2 Press **SYSTEM MENU**.  
The System Menu appears.

- 3 Select “**Setup**,” and press **ENTER**.

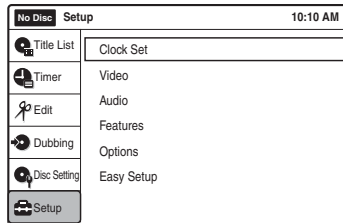

- 4 Select “**Options**,” and press **ENTER**.

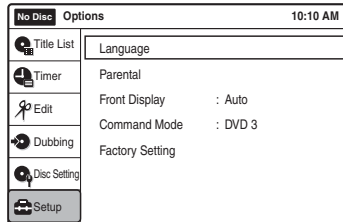

- 5 Select “**Command Mode**,” and press **ENTER**.

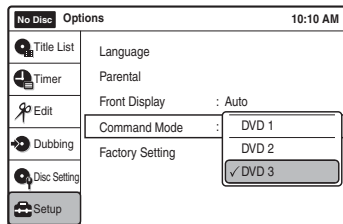

- 6 Select a command mode (“**DVD 1**,” “**DVD 2**,” or “**DVD 3**”), and press **ENTER**.

## 7 Set the command mode for the remote so it matches the command mode for the recorder you set above.

Follow the steps below to set the command mode on the remote.

- ① Hold down ENTER.
- ② While holding down ENTER, enter the command mode code number using the number buttons.

Command Mode	Code number
DVD1	number button 1
DVD2	number button 2
DVD3	number button 3

- ③ Hold down both the number buttons and ENTER at the same time for more than three seconds.

### To return to the previous display

Press RETURN.

### To check the command mode for the recorder

Press (stop) on the recorder when the recorder is turned off. The command mode for the recorder appears in the front panel display.

If the command mode for the recorder has not been changed, set the command mode for the remote to the default setting of DVD3. If the command mode for the remote is changed to DVD1 or DVD2, you will be unable to operate this recorder.

## Step 7: Easy Setup

Follow the steps below to make the minimum number of basic adjustments for using the recorder.

Settings are made in the following order.

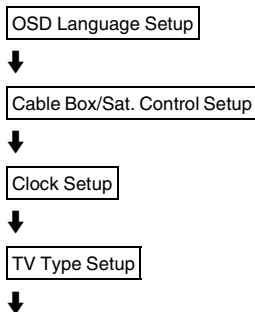

### Finished!

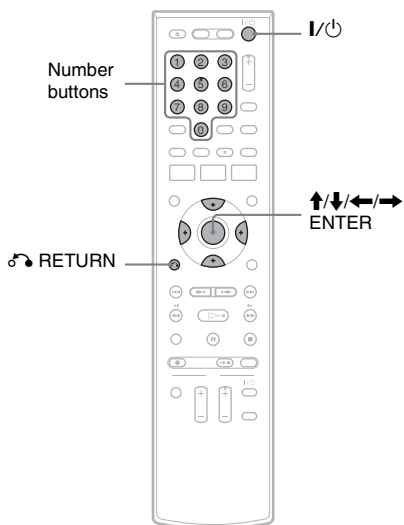

**1** Turn on the TV.

**2** Press I/Power.

The recorder turns on.

### 3 Switch the input selector on your TV so that the signal from the recorder appears on your TV screen.

“Initial settings necessary to operate the DVD recorder will be made. You can change them later using setup.” appears.

- If this message does not appear, select “Easy Setup” in the “Setup” display to run Easy Setup (page 106).

### 4 Press ENTER.

The setup display for selecting the language used in the on-screen display appears.

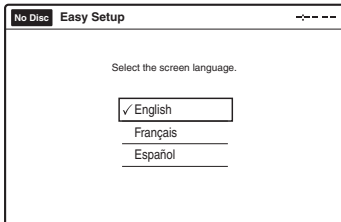

### 5 Select a language, and press ENTER.

The setup display for cable box/satellite receiver control appears.

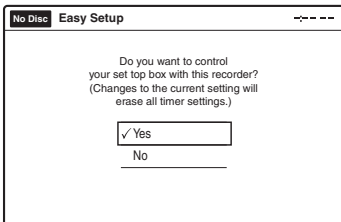

### 6 Select whether or not you use the cable box/satellite receiver control, and press ENTER.

If you want to use the cable box/satellite receiver control (page 12), select “Yes.” If not, select “No,” then go to step 9.

### 7 Press the number buttons to enter the brand code of your cable box/satellite receiver.

See “Cable Box/Satellite Receiver Brand Code” (page 121).

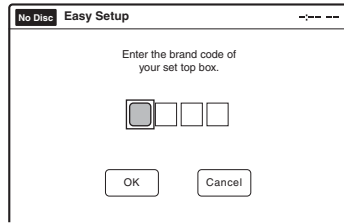

- To re-enter the code number, select “Cancel” and return to step 6.

### 8 Select “OK,” and press ENTER.

The setup display for clock setting appears.

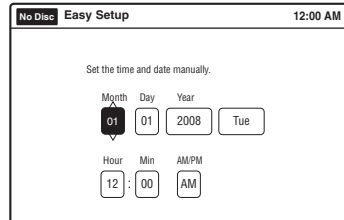

### 9 Press ↑/↓ to set the month and press →.

Set the day, year, hour, minutes, and AM/PM in the same way, then press ENTER. The day of the week is set automatically.

The setup display for selecting the picture size of the connected TV appears.

### 10 Select the setting that matches your TV type.

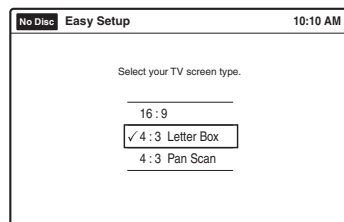

“16:9”: For wide-screen TVs or TVs with a wide screen mode.

“4:3 Letter Box”: For 4:3 screen TVs.

Displays “wide screen” pictures with bands on the upper and lower sections of the screen.

“4:3 Pan Scan”: For 4:3 screen TVs.

Automatically displays “wide screen” pictures on the entire screen and cuts off the sections that do not fit.

For details, see “Video Settings (Video)” on page 98.



## 11 Press ENTER.

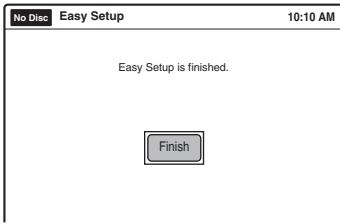

## 12 Press ENTER when “Finish” appears.

Easy Setup is finished. All connections and setup operations are complete. If you use the cable box/satellite receiver control, check that the control works correctly (page 25).

### To return to the previous display

Press  RETURN.

#### Hint

If you want to run Easy Setup again, select “Easy Setup” in the “Setup” display (page 106).

#### Note

To record TV programs using the timer, you must set the clock accurately.

## Checking the cable box/satellite receiver control setting

- 1 Turn on the recorder and the cable box/satellite receiver.
- 2 Point the recorder’s remote at the recorder (not at the cable box/satellite receiver).
- 3 Press CH +/- and check that the channel changes on the cable box/satellite receiver window.
- 4 Press the number buttons and check that the channel changes on the cable box/satellite receiver window.

### If you cannot get the recorder to control your cable box/satellite receiver

Check the settings at “Set Top Box Control” in the “Features” setup (page 103).

Check the connection and place the set top box controller near the cable box/satellite receiver (page 12).

If your cable box or satellite receiver still does not operate with this recorder, contact your cable or satellite company to see if they can provide you with a compatible cable box or satellite receiver.

### To fix the set top box controller to your cable box/satellite receiver

Once you have confirmed that the set top box controller controls your cable box or satellite receiver, affix it in place.

- 1 Attach the supplied double-sided tape to the set top box controller. Remove the backings on the double-sided tape.

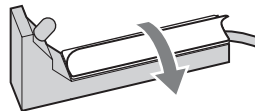

- 2** Affix it so that the set top box controller is near the remote control sensor on your cable box/satellite receiver.

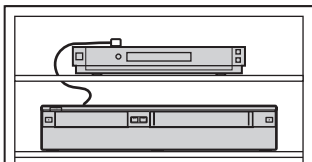

## Connecting Another VCR or Similar Device

After disconnecting the recorder's power cord from an AC outlet, connect the other VCR or similar recording device to the LINE IN jacks of this recorder. Also refer to the operating instructions supplied with the connected equipment.

If you connect equipment that has a timer function, you can use the Synchro Rec function (pages 54 and 80). In this case, connect the equipment to the LINE 1 IN (VIDEO/AUDIO) jacks (page 13).

For connection to the DV IN or USB jack on the front panel, see page 86 or 89.

## Connecting to the LINE 2 IN jacks on the front panel

Connect other VCR or similar device to the LINE 2 IN jacks of this recorder.

You can connect a second DVD player and record DVDs.

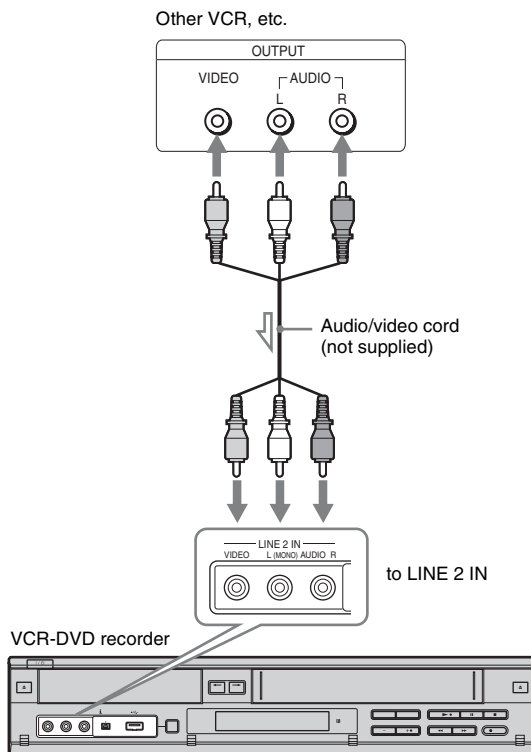

 : Signal flow

### Hints

- When the connected equipment outputs only monaural sound, connect an audio cord to the white LINE IN AUDIO L (mono) jack.
- To record from connected equipment, select an input source (LINE1 or LINE2) to match the jack you connected to (pages 56 and 82).

## Notes

- Do not connect more than one type of video cord between the recorder and your TV at the same time.
- Pictures containing copy protection signals that prohibit any copying cannot be recorded. You cannot dub from DVD VIDEOS to this recorder.
- Do not connect the output jack of this recorder to another equipment's input jack with the other equipment's output jack connected to the input jack of this recorder. Noise (feedback) may result.
- If you pass the recorder signals via the VCR, you may not receive a clear image on your TV screen.

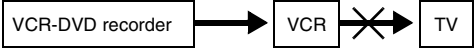



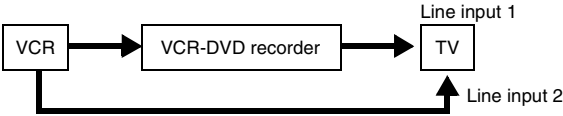









Be sure to connect your VCR to the VCR-DVD recorder and your TV in the order shown below. To watch video tapes, watch the tapes through a second line input on your TV.





## Recordable and Playable Discs

Disc Type		Disc Logo	Icon used in this manual	Formatting (new discs)	Compatibility with other DVD players (finalizing)
DVD+RW		 DVD+ ReWritable		Automatically formatted	Playable on DVD+RW compatible players (automatically finalized)
DVD-RW	VR mode			Format in VR mode* <sup>2</sup> (page 48)	Playable only on VR mode compatible players (finalization unnecessary) (page 66)
	Video mode			Format in Video mode* <sup>2</sup> (page 48)	Playable on most DVD players (finalization necessary) (page 66)* <sup>7</sup>
DVD+R				Automatically formatted	Playable on DVD+R compatible players (finalization necessary) (page 66)* <sup>7</sup>
DVD+R DL					
DVD-R	VR mode			Format in VR mode using the "Disc Setting" display (page 64)	Playable only on DVD-R VR mode compatible players (finalization necessary) (page 66)
	Video mode			Automatically formatted in Video mode	Playable on most DVD players (finalization necessary) (page 66)* <sup>7</sup>

### Usable disc versions (as of December 2007)

- 8x-speed or slower DVD+RWs
- 6x-speed or slower DVD-RWs (Ver.1.1, Ver.1.2 with CPRM\*<sup>1</sup>)
- 16x-speed or slower DVD+Rs
- 16x-speed or slower DVD-Rs (Ver.2.0, Ver.2.1 with CPRM)
- 8x-speed or slower DVD+R DL (Double Layer) discs\*<sup>6</sup>

### Discs that cannot be recorded on

- 8 cm discs
- DVD-RAMs

"DVD+RW," "DVD-RW," "DVD+R," "DVD+R DL," and "DVD-R" logos are trademarks.

	Recording Features		Editing Features				
	Rewrite (page 64)	Auto Chapter (page 50)	Change Title Name (page 61)	Erase Title/ Chapter (page 58)	A-B Erase (page 59)	Divide Title (page 60)	Playlist (page 62)
	Yes	Yes	Yes	Yes/No <sup>*3</sup>	Yes	Yes	No
	Yes	Yes	Yes	Yes/Yes <sup>*4</sup>	Yes	Yes	Yes
	Yes	Yes	Yes	Yes/No <sup>*3</sup>	No	No	No
	No	Yes	Yes	Yes/No <sup>*5</sup>	No	No	No
	No	Yes	Yes	Yes/Yes <sup>*5</sup>	Yes	Yes	Yes
	No	Yes	Yes	Yes/No <sup>*5</sup>	No	No	No

<sup>\*1</sup> CPRM (Content Protection for Recordable Media) is a coding technology that protects copyrights for images.

<sup>\*2</sup> Unused DVD-RWs are automatically formatted according to the setting of “Format DVD-RW” in “Features” setup (page 103).

<sup>\*3</sup> Erasing titles only frees up disc space if you erase the last title.











<sup>\*4</sup> Erasing titles or chapters frees up disc space.

<sup>\*5</sup> Erasing titles or chapters does not free up disc space.

<sup>\*6</sup> When using DVD+R DL (Double Layer) discs, see the instructions supplied with the discs.

<sup>\*7</sup> For DVD-RWs (Video mode), DVD-Rs (Video mode), and DVD+Rs, the Auto Finalize function is available (page 67).

# Playable Discs

Disc Type	Disc Logo	Icon used in this manual	Characteristics
DVD VIDEO			Discs such as movies that can be purchased or rented
DVD-RAM	—		DVD-RAMs recorded by another recording device. 12 cm discs without cartridges, or removable from their cartridges can be played.
VIDEO CD			VIDEO CDs or CD-Rs/CD-RWs in VIDEO CD format (with PBC function)
CD			Music CDs or CD-Rs/CD-RWs in music CD format that can be purchased
DATA CD			CD-ROMs/CD-Rs/CD-RWs created on a PC or similar device in music format, or MP3 <sup>*1</sup> or JPEG format that conforms to ISO9660 <sup>*2</sup> Level 1/Level 2
DATA DVD	—		DVD-ROMs/DVD+RWs/DVD-RWs/DVD+Rs/DVD-Rs in MP3 <sup>*1</sup> or JPEG format conforming to Universal Disk Format (UDF)
8 cm DVD+RW/ DVD-RW/DVD-R	—	—	8 cm DVD+RWs, DVD-RWs, and DVD-Rs recorded with a DVD video camera (Still images recorded with a DVD video camera cannot be played.)

“DVD VIDEO” and “CD” logos are trademarks.

\*1 MP3 (MPEG1 Audio Layer 3) is a standard format defined by ISO/MPEG which compresses audio data.

\*2 A logical format of files and folders on DATA-CDs, defined by ISO (International Organization for Standardization).

## Discs that cannot be played

- CD-ROMs/CD-Rs/CD-RWs that are not recorded in music CD or Video CD format, or do not contain MP3 audio tracks or JPEG image files.
- Data part of CD-Extras
- DVD-ROMs that are not recorded in DVD Video format, or do not contain MP3 audio tracks or JPEG image files.
- DVD Audio discs
- HD layer on Super Audio CDs
- DVD VIDEOS with a different region code (see page 33)
- A disc recorded in a color system other than NTSC, such as PAL or SECAM
- A disc recorded in AVCHD format



## Note on playback operations of DVD VIDEOS/VIDEO CDs

Some playback operations of DVD VIDEOS/VIDEO CDs may be intentionally set by software producers. Since this recorder plays DVD VIDEOS/VIDEO CDs according to the disc contents the software producers designed, some playback features may not be available. Also, see the instructions supplied with the DVD VIDEOS/VIDEO CDs.

## Note on DualDiscs

A DualDisc is a two sided disc product which mates DVD recorded material on one side with digital audio material on the other side. However, since the audio material side does not conform to the Compact Disc (CD) standard, playback on this product is not guaranteed.

## Region code (DVD VIDEO only)

Your recorder has a region code printed on the rear of the unit and will only play DVD VIDEOS (playback only) labeled with identical region codes. This system is used to protect copyrights. DVD VIDEOS labeled  will also play on this recorder.

If you try to play any other DVD VIDEO, a message will appear on the TV screen to indicate that the disc is not playable. Depending on the DVD VIDEO, no region code indication may be labeled even though playing the DVD VIDEO is prohibited by area restrictions.

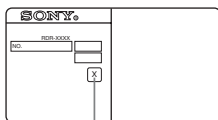

Region code

## Music discs encoded with copyright protection technologies

This product is designed to playback discs that conform to the Compact Disc (CD) standard. Recently, various music discs encoded with copyright protection technologies are being marketed by some record companies. Please be aware that among those discs, there are some that do not conform to the CD standard and may not be playable by this product.

## Note on DVD+RWs/DVD+Rs, DVD-RWs/DVD-Rs, or CD-RWs/CD-Rs recorded on other equipment

Some DVD+RWs/DVD+Rs, DVD-RWs/DVD-Rs, or CD-RWs/CD-Rs cannot be played on this recorder due to the recording quality or physical condition of the disc, or the characteristics of the recording device and authoring software. The disc will not play if it has not been correctly finalized. For more information, see the operating instructions for the recording device.

## Notes

- You cannot mix VR mode and Video mode on the same DVD-RW or DVD-R. To change the DVD-RW's format, reformat the disc (page 64). Note that a disc's contents will be erased after reformatting.
- You cannot shorten the time required for recording even with high-speed discs. Also, you cannot record on the disc if the disc is not 1x speed compatible.
- It is recommended that you use discs with "For Video" printed on their packaging.
- You cannot add new recordings to DVD-RWs (Video mode), DVD+Rs, or DVD-Rs (Video mode) recorded on other equipment.
- You may not be able to further record on a DVD+RW recorded on other equipment. Note that recording on such discs may cause the recorder to rewrite the DVD menu.
- If the disc contains PC data unrecognizable by this recorder, the data may be erased.

## DVD/USB Playback

# Playing Discs

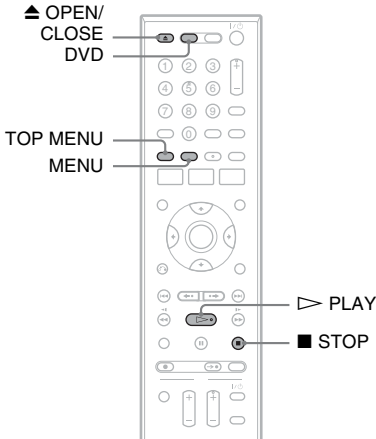

- 1 Press **DVD** to operate the DVD recorder.
- 2 Press **▲ OPEN/CLOSE**, and place a disc on the disc tray.

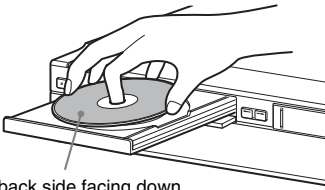

Playback side facing down

- 3 Press **▲ OPEN/CLOSE** to close the disc tray.  
Wait until "LOAD" disappears from the front panel display.
- 4 Press **▷ PLAY**.  
Playback starts.

### To stop playback

Press **■ STOP**.

### Hints

- You can play DATA CDs or DATA DVDs with MP3 audio tracks or JPEG image files (pages 41 or 42).
- If you insert a DVD VIDEO, VIDEO CD, or CD, playback starts automatically depending on the disc.
- When playing a DVD+RW, DVD-RW, DVD+R, DVD-R, and DVD-RAM, you can select the title from the Title List menu (page 38).
- When using a DVD-RAM with a cartridge, remove the disc from the cartridge.

### Notes

- To play a disc recorded with other equipment on this recorder, finalize the disc on the recording equipment first.
- For simultaneous VHS and DVD operation, see page 9.

## Using the DVD's Menu



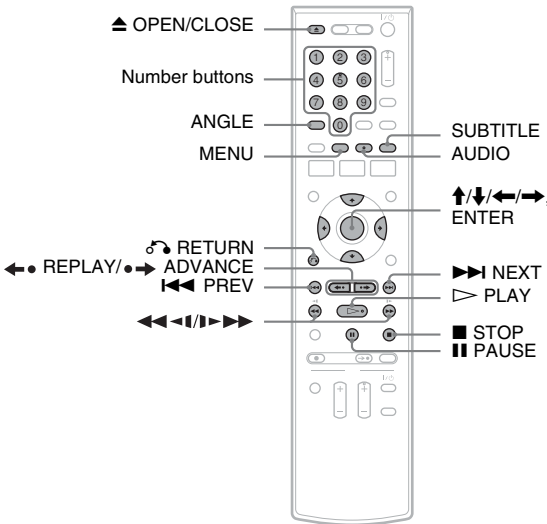

When you play a DVD VIDEO, or a finalized DVD+RW, DVD-RW (Video mode), DVD+R, or DVD-R (Video mode), you can display the disc's menu by pressing **TOP MENU** or **MENU**.

# Playback Options



Button	Operation	Disc
▲ OPEN/CLOSE	Stops playing and opens the disc tray.	All discs
AUDIO	<p>Selects one of the audio tracks recorded on the disc when pressed repeatedly.</p> <p><b>-RWVR</b> <b>-RVR</b> : Selects the main or sub sound.</p> <p><b>DVD</b> : Selects the audio source.</p> <p><b>VCD</b> : Selects stereo or monaural audio tracks.</p>	<b>-RWVR</b> <b>-RVR</b> <b>DVD</b> <b>VCD</b>
SUBTITLE	Selects a subtitle language when pressed repeatedly.	<b>DVD</b>
ANGLE	Selects an angle when pressed repeatedly. If various angles (multi-angles) for a scene are recorded on the disc, “  ” appears on the TV screen for a few seconds. See the instructions supplied with the disc for details.	<b>DVD</b>
◀• REPLAY/ •▶ ADVANCE	<ul style="list-style-type: none"> <li>Replays or briefly fast forwards a scene when pressed during playback.</li> <li>Goes to the previous or next frame when pressed during pause mode.</li> </ul>	<b>+RW</b> <b>-RWVR</b> <b>-RWVideo</b> <b>+R</b> <b>-RVR</b> <b>-RVideo</b> <b>DVD</b> <b>RAM</b>
◀◀ PREV/ ▶▶ NEXT	<ul style="list-style-type: none"> <li>Goes to the beginning of the current or next title/chapter/scene/track and starts playback when pressed during playback.</li> <li>Goes to the beginning of the previous title/chapter/scene/track when ◀◀ PREV is pressed within three seconds after starting a title/chapter/scene/track.</li> </ul>	All discs

Button	Operation	Disc																	
 (fast reverse/fast forward)	Fast reverses or fast forwards the disc when pressed during playback. Search speed changes with each press: <table style="margin-left: auto; margin-right: auto;"> <tr> <td style="padding: 0 10px;">fast reverse</td> <td style="padding: 0 10px;">fast forward</td> </tr> <tr> <td style="padding: 0 10px;">FR1 ←</td> <td style="padding: 0 10px;">→ FF1<sup>*1</sup></td> </tr> <tr> <td style="padding: 0 10px;">FR2<sup>*2</sup> ← ←</td> <td style="padding: 0 10px;">→ → FF2<sup>*2</sup></td> </tr> <tr> <td style="padding: 0 10px;">FR3<sup>*3</sup> ← ← ←</td> <td style="padding: 0 10px;">→ → → FF3<sup>*3</sup></td> </tr> </table>	fast reverse	fast forward	FR1 ←	→ FF1 <sup>*1</sup>	FR2 <sup>*2</sup> ← ←	→ → FF2 <sup>*2</sup>	FR3 <sup>*3</sup> ← ← ←	→ → → FF3 <sup>*3</sup>	All discs  <sup>*1</sup> FF1 with sound (Scan Audio) is available for DVDs with Dolby Digital soundtracks. <sup>*2</sup> FR2 and FF2 are not available for MP3. <sup>*3</sup> FR3 and FF3 are only available for DVDs and VIDEO CDs.									
fast reverse	fast forward																		
FR1 ←	→ FF1 <sup>*1</sup>																		
FR2 <sup>*2</sup> ← ←	→ → FF2 <sup>*2</sup>																		
FR3 <sup>*3</sup> ← ← ←	→ → → FF3 <sup>*3</sup>																		
 (slow)	Plays in slow motion when pressed in pause mode. Playback speed changes with each press: <table style="margin-left: auto; margin-right: auto;"> <tr> <td style="padding: 0 10px;">reverse slow motion</td> <td style="padding: 0 10px;">forward slow motion</td> </tr> <tr> <td style="padding: 0 10px;">◀ 3 ←</td> <td style="padding: 0 10px;">→ 3 ▶</td> </tr> <tr> <td style="padding: 0 10px;">◀ 2 ← ←</td> <td style="padding: 0 10px;">→ → 2 ▶ ▶</td> </tr> <tr> <td style="padding: 0 10px;">◀ 1 ← ← ←</td> <td style="padding: 0 10px;">→ → → 1 ▶ ▶ ▶</td> </tr> </table>	reverse slow motion	forward slow motion	◀ 3 ←	→ 3 ▶	◀ 2 ← ←	→ → 2 ▶ ▶	◀ 1 ← ← ←	→ → → 1 ▶ ▶ ▶	<table style="width: 100%; border-collapse: collapse;"> <tr> <td style="border: 1px solid black; padding: 2px;">+RW</td> <td style="border: 1px solid black; padding: 2px;">-RWV/R</td> <td style="border: 1px solid black; padding: 2px;">-RWVideo</td> </tr> <tr> <td style="border: 1px solid black; padding: 2px;">+R</td> <td style="border: 1px solid black; padding: 2px;">-R/V/R</td> <td style="border: 1px solid black; padding: 2px;">-RVideo</td> </tr> <tr> <td style="border: 1px solid black; padding: 2px;">DVD</td> <td style="border: 1px solid black; padding: 2px;">RAM</td> <td style="border: 1px solid black; padding: 2px;">VCD<sup>*</sup></td> </tr> </table> <p><sup>*</sup> Playback direction only</p>	+RW	-RWV/R	-RWVideo	+R	-R/V/R	-RVideo	DVD	RAM	VCD <sup>*</sup>
reverse slow motion	forward slow motion																		
◀ 3 ←	→ 3 ▶																		
◀ 2 ← ←	→ → 2 ▶ ▶																		
◀ 1 ← ← ←	→ → → 1 ▶ ▶ ▶																		
+RW	-RWV/R	-RWVideo																	
+R	-R/V/R	-RVideo																	
DVD	RAM	VCD <sup>*</sup>																	
<b>   PAUSE</b>	Pauses playback. If you pause playback for more than five minutes, playback starts automatically.	All discs																	

To resume normal playback after playing at various speeds, press ▷ PLAY.

### Hints

- You can change playback options, such as subtitle, audio track, angle, etc., using the OPTIONS menu (page 11).
- During playback or pause mode, the recorder's ◀◀/▶▶ buttons and the remote's ◀◀PREV/▶▶NEXT buttons work the same way (page 35). Hold the buttons down during playback to fast reverse or fast forward. In pause mode, you can play in slow motion. Three speeds are available, depending on the duration of the press.
- See “DVD Audio/Subtitle Language” on page 120 for the meaning of the language abbreviation.

### Notes

- If you pause playback of a CD, or DATA CD/DATA DVD containing MP3 audio tracks, playback will not start until you press ▷ PLAY or || PAUSE.
- Sound will be interrupted during Scan Audio (page 37).

### Notes on playing DTS soundtracks on a CD

When playing DTS-encoded CDs, excessive noise will be heard from the analog stereo jacks. To avoid possible damage to the audio system, the consumer should take proper precautions when the analog stereo jacks of the recorder are connected to an amplification system. To enjoy DTS Digital Surround™ playback, an external 5.1-channel decoder system must be connected to the digital jack of the recorder.

### Notes on playing DVDs with a DTS soundtrack

DTS audio signals are output only through the DIGITAL AUDIO OUT (COAXIAL)/HDMI OUT jack.

When you play a DVD with DTS soundtracks, set “Digital Out” – “DTS” to “On” of “Audio” in the “Setup” display (page 100).

If you connect the recorder to audio equipment without a DTS decoder, do not set “DTS” to “On” in “Audio” setup. A loud noise (or no sound) may come out from the speakers, which might disturb your ears or cause damage to the speakers.

## Playing quickly with sound (Scan Audio) (DVDs with Dolby Digital soundtracks only)

You can play quickly with dialog or sound during FF1 fast-forward of a DVD with Dolby Digital soundtracks. Simply press ►► during playback.

### Hint

To turn off the Scan Audio function, set “Scan Audio” of “Audio” to “Off” in the “Setup” display (page 101).

### Note

Sound will be interrupted during Scan Audio.

## Playing VIDEO CDs with PBC functions

### VCD

PBC (Playback Control) allows you to play VIDEO CDs interactively using a menu on your TV screen.

When you start playing a VIDEO CD with PBC functions, a menu appears.

Select an item using the number buttons and press ENTER. Then follow the instructions in the menu (press ► PLAY when “Press SELECT” appears).

Operations differ depending on the disc. See the instructions supplied with the disc.

### To cancel PBC Playback

Press MENU to display “Menu: Off.” To use the PBC functions, press MENU again to display “Menu:On.”

## Resuming playback from the point where you stopped the disc (Resume Play)

Press ► PLAY again after stopping a disc to resume playback from the same point.

To start from the beginning, press ■ STOP twice, and press ► PLAY.

The point where you stopped playing is cleared when:

- you open the disc tray.
- you play another title.
- you switch the Title List menu to original or Playlist (DVD-RW (VR mode)/DVD-R (VR mode)/DVD-RAM only).

- you edit the title after stopping playback.
- you make a recording.

## Playing restricted DVDs (Parental Control)

### DVD

If you play a restricted DVD, a message appears asking whether you want to override the restriction.

- 1 Select “OK” and press ENTER.  
The display for entering your password appears.
- 2 Enter your four digit password using the number buttons.  
The recorder starts playback.

To register or change the password, see “Parental (DVD VIDEOS only)” on page 105.

## Locking the recorder (Child Lock)

You can lock all of the buttons on the recorder so that the settings are not canceled by mistake.

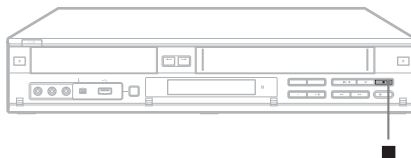

With the recorder turned on and stopped, hold down ■ (stop) on the recorder for more than ten seconds. The recorder turns off and “CHILD LOCK” appears in the front panel display. The ☹ indicator remains lit if there is a timer setting. The recorder will not work except for timer recordings.

To unlock the recorder, hold down ■ on the recorder until “CHILD LOCK” disappears from the front panel display. The recorder is unlocked and turns on.

To stop timer recording while the recorder is locked, press ■ twice. The recording stops and the recorder is unlocked.

### Note

The recorder will be unlocked when:

- you stop timer recording by pressing ■.
- you insert a tape.

## One-Touch Play (for HDMI connections only)

Press PLAY. With one touch of the PLAY button, your TV automatically turns on and the TV's input is switched to the recorder. Playback starts automatically. Set "Control for HDMI" to "On" in the "Features" setup (page 104) to use this function. The TV's input will also switch to the recorder automatically if a disc with auto play function is loaded.

### Notes

- When using the HDMI connection, there may be a delay, before the playback picture appears on the TV screen, and the beginning portion of the playback picture may not be displayed.
- The function does not work when playing an audio CD, MP3 audio track, or VHS tape.
- The function works only when the recorder is turned on.

## Playing a Title From the Title List



The Title List menu displays the program titles on the disc.

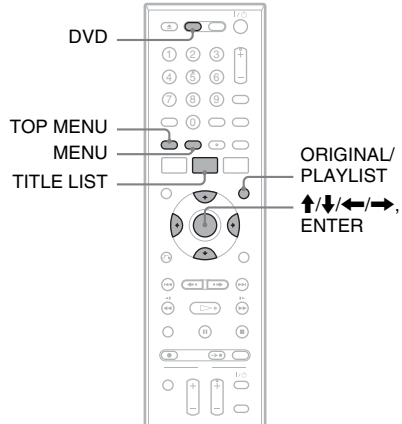

- 1 Press DVD to operate the DVD recorder.
- 2 Place a disc on the disc tray.
- 3 Press TITLE LIST.

Example: DVD-RW (VR mode)

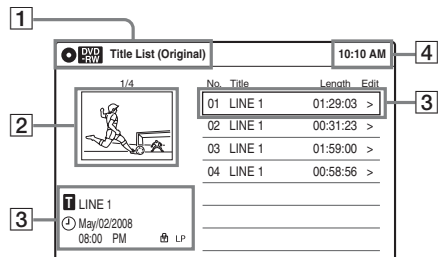

- 1 Disc type:  
Displays a disc type. Also displays the title type (original or Playlist) for DVD-RWs (VR mode), DVD-Rs (VR mode), and DVD-RAMs.
- 2 Movie thumbnail image
- 3 Title information:  
Displays the title number, title name, recording date, and recording mode. "Ⓜ" indicates a protected title, while "Ⓜ" indicates unprotected.
- 4 Clock

#### 4 Select the title, and press ENTER.

The sub-menu appears.

#### 5 Select “Play,” and press ENTER.

Playback starts from the selected title on the disc.

### About the Title List for DVD-RWs (VR mode) and DVD-Rs (VR mode)

You can switch the Title List to show an original or Playlist.

While the Title List menu is turned on, press ORIGINAL/PLAYLIST repeatedly to select either “Title List (Original)” or “Playlist.”

For details, see “Edit options for DVD-RWs (VR mode)/DVD-Rs (VR mode)” on page 57.

### To turn off the Title List

Press TITLE LIST.

#### Hint

You can also switch the Title List of DVD-RAMs to show an original or Playlist.

### Notes

- The Title List does not appear for DVD-RWs (Video mode), DVD+Rs, or DVD-Rs (Video mode) that have been finalized. To view a title, press TOP MENU or MENU (page 34).
- The Title List may not appear for discs created on other DVD recorders.
- Letters that cannot be displayed are replaced with “\*.”

## Searching for a Title/Chapter/Track, etc.



You can search a DVD by title or chapter, and VIDEO CD by track or scene. As titles and tracks are assigned individual numbers on the disc, select the title or track by entering its number. You can also search for a scene using the time code.

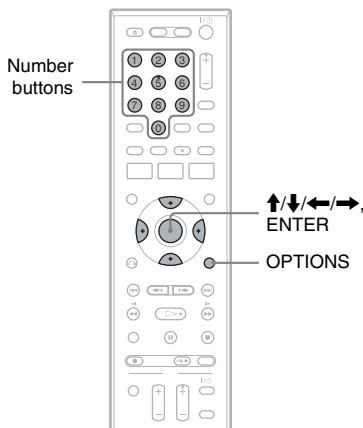

### 1 Press **OPTIONS** during playback.

The **OPTIONS** menu appears.

### 2 Select a search method.

“Title” (for DVDs)

“Chapter” (for DVDs)

“Track” (for VIDEO CDs with PBC function off)

“Time” (for DVDs/VIDEO CDs with PBC function off): Searches for a starting point using the time code.

### 3 Press **↑/↓/←/→** to select the number of the title, chapter, track, etc., you want, or press the number buttons to enter the time code.

For example: “Time”

To find a scene at 2 hours, 5 minutes, and 20 seconds, enter “20520.”

If you make a mistake, wait a moment until the display returns to the elapsed playing time display, then select another number.

## 4 Press ENTER.

The recorder starts playback from the selected point.

To turn off the display, press OPTIONS.

### Notes

- Depending on the disc, you may not be able to use the OPTIONS menu to search for a title/chapter/track, or enter the time code for a playback point.
- When playing a Playlist title, you may not be able to search for a scene using the time code.

## Displaying the Playing Time and Play Information



You can check disc information, such as playing time, recording mode, and remaining disc space.

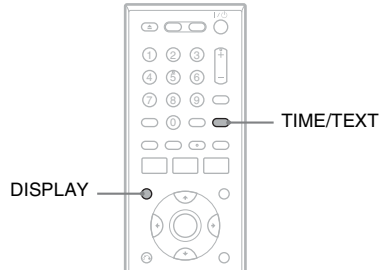

### Press DISPLAY.

The information display appears.

Each time you press the button, the display changes as follows:

Disc and tape information/date and time



Disc information only



No display

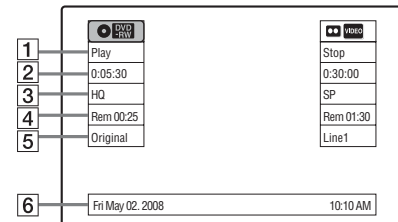

### ◆ DVD

- 1 Playing status
- 2 Playing time
- 3 Recording mode
- 4 Remaining disc space (in stop mode)  
Remaining time of the current title (during playback<sup>\*1</sup>)
- 5 Input source<sup>\*2</sup>
- 6 Date and time



\*1 Also appears in stop mode with Resume Play activated (page 37).

\*2 Title type (original or Playlist) for DVD-RWs (VR mode)/DVD-Rs (VR mode)/DVD-RAMs.

## Viewing information on the front panel display

You can view the information on the front panel display.

### Press TIME/TEXT repeatedly.

The displays differ depending on the disc type or playing status.

Example: When playing a DVD

Playing time of the current title

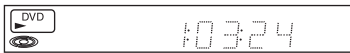

Current title number and current chapter number



Clock

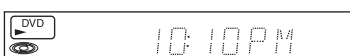

Example: When a DVD is stopped

Clock



Current title and chapter number



Remaining disc space



Input source

Example: When playing a CD

Playing time of the current track



Current track number



Clock

# Playing MP3 Audio Tracks and JPEG Image Files on the Disc

DATA CD DATA DVD

You can play DATA CDs (CD-ROMs/CD-Rs/CD-RWs)/DATA DVDs (DVD-ROMs/DVD+RWs/DVD-RWs/DVD+Rs/DVD-Rs) that contain MP3 audio tracks or JPEG image files.

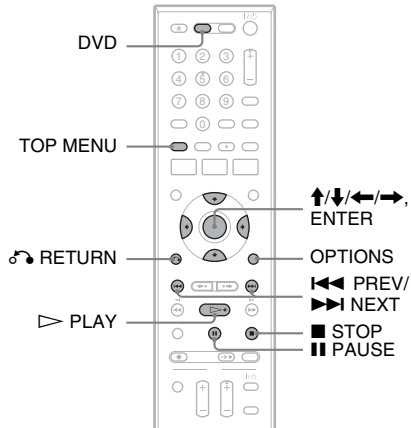

DVD/USB Playback

## Playing MP3 audio tracks

You can play MP3 audio tracks on DATA CDs or DATA DVDs.

- 1 Press DVD to operate the DVD recorder.
- 2 Place a DATA CD/DATA DVD on the disc tray.

When you insert a DATA CD/DATA DVD containing MP3 audio tracks and JPEG image files, the display for selecting a media type appears. When you select "Mix," you can enjoy a slide show with sound (page 43).

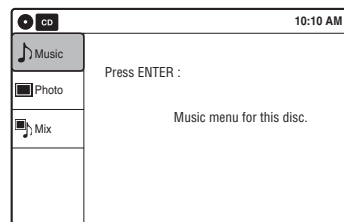

If you insert a DATA CD/DATA DVD containing only MP3 audio tracks, the “Music” display appears. Go to step 4.

**3 Select “Music,” and press ENTER.**

The “Music” display appears.

**4 Select an album, and press ENTER.**

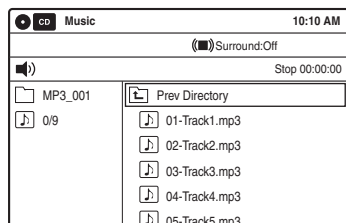

**5 Select a track, and press ENTER.**

Playback starts from the selected track. When a track or album is being played, the title is shown in a box.

**To stop playback**

Press ■ STOP.

**To pause playback**

Press ■ PAUSE.

To restart playback, press ▷ PLAY or ■ PAUSE.

**To return to the previous display**

Press ↶ RETURN.

**To switch between MP3 audio tracks and JPEG image files**

Press ■ STOP, and press TOP MENU.

**Hint**

When playback of all the MP3 audio tracks within the album finishes, the recorder stops.

## Playing JPEG image files

You can play JPEG image files on DATA CDs or DATA DVDs.

**1 Press DVD to operate the DVD recorder.**

**2 Place a DATA CD/DATA DVD on the disc tray.**

When you insert a DATA CD/DATA DVD containing MP3 audio tracks and JPEG image files, the display for selecting a media type appears. When you select “Mix,” you can enjoy a slide show with sound (page 43).

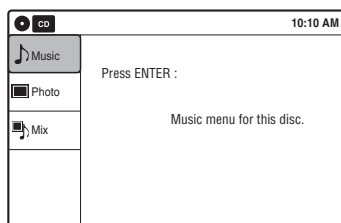

If you insert a DATA CD/DATA DVD containing only JPEG image files, the “Photo” display appears. Go to step 4.

**3 Select “Photo,” and press ENTER.**

The “Photo” display appears.

**4 Select a folder, and press ENTER.**

Directory information

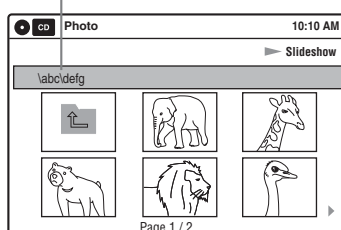

To display the previous or next page, press ◀◀ PREV/▶▶ NEXT.

**5 Select an image file, and press ENTER.**

The selected image is displayed over the entire screen.

To display the previous or next image, press ◀◀ PREV/▶▶ NEXT.

The following menu icons appear in the upper part of the screen.

◀◀: Returns to the “Photo” display.

▶▶: Starts the slide show (page 43).

 : Rotates the image (page 43).

 : Zooms the image (page 43).

Press **OPTIONS** to turn on/off the menu icons.

## To play the slide show

**1** Press **←/→** to select “,” and press **ENTER**.

The “Slideshow Speed” menu appears.

“”: Slow

“”: Normal

“”: Fast

**2** Press **←/→** to select the desired play speed, and press **ENTER**.

The slide show starts from the selected image.

To stop playing, press **■ STOP**.

## To rotate the selected image

Press **←/→** to select “,” and press **ENTER**.

Each time you press **ENTER**, the image turns clockwise by 90°.

## To zoom in an image

Press **←/→** to select “,” and press **ENTER**.

Each time you press **ENTER**, the magnification changes as follows:

2× → 4× → 2× → normal

## To return to the previous display

Press **↶ RETURN**.

## To switch between MP3 audio tracks and JPEG image files

Press **■ STOP**, and press **TOP MENU**.

### Hint

You can also start the slide show by pressing **▷ PLAY** in step 5 above.

### Notes

- You cannot use **↑/↓/←/→** to move the image within the screen while zooming.
- Slide show can play in only one direction.
- You cannot rotate or zoom during slide show.
- If you select “” in the rotated image display, the images in the “Photo” display will not be rotated.

## Enjoying a slide show with sound

When a disc contains both MP3 audio tracks and JPEG image files, you can enjoy a slide show with sound.

**1** Press **DVD** to operate the DVD recorder.

**2** Insert a **DATA CD/DATA DVD** containing both the **MP3 audio tracks and JPEG image files**.

The display for selecting a media type appears.

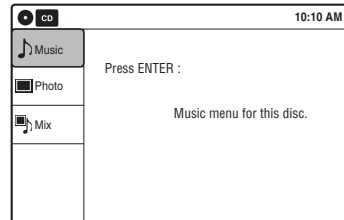

**3** Select “**Mix**,” and press **ENTER**.

The “Music” display appears.

**4** Select an album, and press **ENTER**.

**5** Select a track, and press **ENTER**.

Playback starts from the selected track, and the display asks for confirmation.

**6** Select “**Yes**,” and press **ENTER**.

The “Photo” display appears.

**7** Select the folder you want to view, and press **ENTER**.

**8** Press **▷ PLAY** to start the slide show.

The “Slideshow Speed” menu appears.

**9** Press **←/→** to select the slide show speed, and press **ENTER**.

The slide show starts with sound.

## To stop the slide show

Press **■ STOP**.

### Hint

When playing JPEG images, you can also use the on-screen menu. For details, see “Playing JPEG image files” (page 42).

## About MP3 audio tracks and JPEG image files

MP3 is audio compression technology that satisfies the ISO/IEC MPEG regulations.

JPEG is image compression technology. You can play back DATA CDs (CD-ROMs/CD-Rs/CD-RWs) or DATA DVDs (DVD-ROMs/DVD+RWs/DVD-RWs/DVD+Rs/DVD-Rs) recorded in MP3 (MPEG1 Audio Layer 3) and JPEG format.

However, this recorder only plays DATA CDs whose logical format is ISO9660 Level 1/Level 2 or Joliet, and DATA DVDs of Universal Disk Format (UDF).

See the instructions supplied with the disc drives and the recording software (not supplied) for details on the recording format.

### Hint

The recorder can play MP3 audio tracks or JPEG image files stored in a USB device connected to the USB jack (page 45).

### Note

The recorder may not be able to play some DATA CDs or DATA DVDs created in the Packet Write format.

### MP3 audio tracks or JPEG image files that the recorder can play

The recorder can play the following tracks and files:

- MP3 (MPEG1 Audio Layer 3) audio tracks.
- MP3 audio tracks with the extension “.MP3.”
- JPEG image files with the extension “.JPEG” or “.JPG.”

### Hints

- If you add numbers (01, 02, 03, etc.) to the front of the file names, the files will be played in that order.
- Since a disc with many trees takes longer to start playback, it is recommended that you create albums with no more than two trees.

### Notes

- Some DATA CDs or DATA DVDs cannot be played on this recorder depending on file format.
  - Only one session of a multi-session DATA DVD can be played back.
  - Only alphabet and numbers can be used for album or track names. Anything else is displayed as an asterisk.
  - The recorder will play any data with the extension “.MP3,” even if they are not in MP3 format. Playing such data may generate a loud noise which could damage your speaker system.
  - The recorder does not conform to audio tracks in MP3PRO format.
  - The recorder can recognize up to 499 MP3 audio tracks within a single album. The recorder may not recognize some discs depending on the recording device used for recording or the disc condition.
  - The recorder can play MP3 audio tracks recorded in the following sampling frequencies: 32 kHz, 44.1 kHz, 48 kHz.
  - ID3 tags cannot be displayed.
  - If you add the extension “.JPG” or “.JPEG” to data not in JPEG format, a message appears indicating that the format is not supported.
  - Depending on the disc or the size or total number of files, playback may take some time to start.
  - The recorder can recognize up to 999 JPEG image files within a single folder. The recorder may not recognize some discs depending on the recording device used for recording or the disc condition.
  - Progressive and lossless compression JPEG image files are not supported.
  - The image size that the recorder can display is limited to width 32 - 7680 pixels by height 32 - 8192 pixels.
  - JPEG image files that conform to the DCF\* image file format are not supported.
- \* “Design rule for Camera File system”: Image standards for digital cameras regulated by JEITA (Japan Electronics and Information Technology Industries Association).

# Playing From a Connected USB Device

You can play MP3 audio tracks or JPEG image files stored in a USB device connected to the USB jack. Also movie files in the connected HDD camcorder can be played. About USB connection and available USB devices, see page 89.

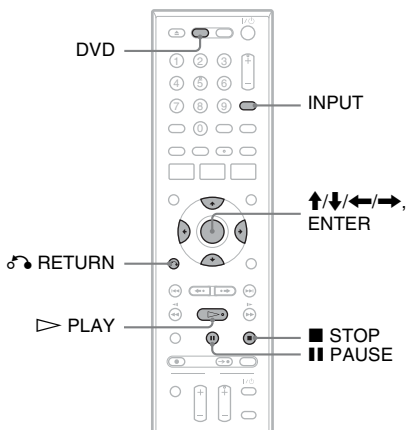

- 1 Press **DVD** to operate the DVD recorder.
- 2 Press **INPUT** repeatedly to select “USB.”
- 3 Connect a USB device to the (USB) jack (page 89).  
Check that the USB indicator lights up in the front panel display.
- 4 Press **▶ PLAY**.  
The display for selecting a media type appears.

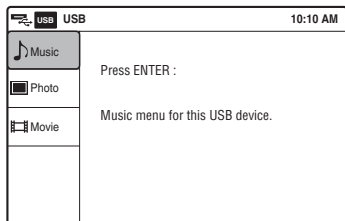

## 5 Select “Photo,” “Music,” or “Movie,” and press ENTER.

- To play MP3 audio tracks, select “Music.”  
See “Playing MP3 audio tracks” (page 41) for details.
- To play JPEG image files, select “Photo.”  
See “Playing JPEG image files” (page 42) for details.
- To play movie files, select “Movie.” The contents of the HDD camcorder are listed.

Example: When “Movie” is selected

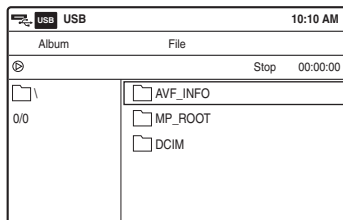

## 6 Select an album (folder) and press ENTER.

The movie file list appears.

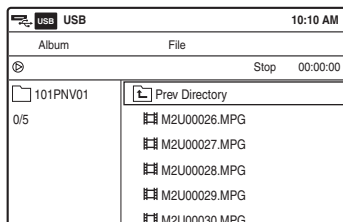

## 7 Select a movie file and press ENTER.

Playback starts.

### To stop playback

Press **■ STOP**.

### To pause playback

Press **▬ PAUSE**.

To restart playback, press **▶ PLAY** or **▬ PAUSE**.

### To return to the previous display

Press **↶ RETURN**.

### To return to the display for selecting a media type

Press **■ STOP** twice, and press **▶ PLAY**.

## Hints

- The recorder can play movie files that are recorded with an HDD camcorder and have the extension “.MPG.”
- You cannot play movie files recorded with a digital still camera.

## Notes

- The recorder may not be able to play some JPEG image files, MP3 audio tracks or movie files that have been edited on a PC.
- Do not disconnect a USB device while reading or playing files.
- Some files may take time to appear. In particular, it may take some time to read many files or large size files, but this is not a malfunction.
- Do not turn off the power while reading or playing files.
- USB cables exclusive for supplying power cannot be used.
- Connect the camcorder or digital still camera directly to the recorder, not via a USB hub or other USB device.

## Before Recording

### Before you start recording...

- This recorder can record on various disc types. Select the disc type according to your needs (page 30).
- Check that the disc has enough available space for the recording (page 40). For DVD+RWs or DVD-RWs, you can free up disc space by erasing titles (page 58).
- Check that the recorder is connected to a tuner such as a cable box or satellite receiver (page 12). See also the tuner's instruction manual.

### Hints

- To play a disc recorded with this recorder on other equipment, finalize the disc (page 66). Note that you cannot further record or edit on a finalized disc.
- If you set "Auto Finalize" to "On" in the "Features" setup (page 103), the Auto Finalize function works for DVD-RWs (Video mode), DVD-Rs (Video mode) and DVD+Rs after recording. For details, see page 67.

### Notes

- Timer recordings will start with or without the recorder turned on. The recorder automatically turns off after a recording has finished.
- This recorder records at  $\times 1$  speed.

### Maximum recordable number of titles

Disc	Number of titles
DVD-RW/DVD-R	99
DVD+RW/DVD+R	49
DVD+R DL	49

## Recording mode

Like the SP or EP recording mode of VCRs, this recorder has eight different recording modes. Select a recording mode according to the time and picture quality you need. For example, if picture quality is your top priority, select "HQ" (high quality). If recording time is your priority, "SLP" can be a possible choice.





Press **REC MODE** repeatedly to switch the recording modes.

I want to record with the best possible picture quality, so I'll select HQ.



### Recording mode and recording time

The following table is an approximate guide for the recording time on a single DVD (4.7 GB).

Recording mode	Approximate recording time (minute)
HQ (High quality)	60
HSP 	90
SP (Standard mode)	120
LSP 	150
ESP 	180
LP 	240
EP 	360
SLP (Long duration)	480

### Hint

The approximate recording time for DVD+R DL (Double Layer) discs is as follows:

HQ: 1 hour 48 minutes  
 HSP: 2 hours 42 minutes  
 SP: 3 hours 37 minutes  
 LSP: 4 hours 31 minutes  
 ESP: 5 hours 25 minutes  
 LP: 7 hours 14 minutes  
 EP: 10 hours 51 minutes  
 SLP: 14 hours 28 minutes

### Notes

- When in a recording mode other than HQ, the recorder compresses the audio/video data before recording. Since the compression rate needs to decrease for fast-moving images or if picture noise is present, recorded data size increases, and available recording time becomes shorter. When recording such pictures, a recording mode offering longer recording time is recommended.
- Situations below may cause inaccuracies with the recording time.
  - Recording fast-moving or images containing picture noise.
  - Recording a program with poor reception, or a program or video source of low picture quality

- Recording on a disc that has already been edited
- Recording only a still picture or just sound
- Since the recording mode for recorded titles is calculated after sampling the recorded data during playback, it may be displayed differently from the mode you selected when recording. However, the actual recording itself is correctly made in the selected mode.

## Notes

- You cannot mix VR mode and Video mode on the same DVD-RW or DVD-R.
- You can change the recording format on DVD-RWs by reformatting (page 64).
- You cannot change the recording format on used DVD-Rs.
- The recorder records on new DVD-Rs in Video mode unless you first format the discs in VR mode.

---

## Recording main and sub sounds

You can record the different soundtracks on a DVD-RW (VR mode) or DVD-R (VR mode) from equipment connected to the LINE 1 IN or LINE 2 IN jacks. When playing the disc, you can select main or sub sound by pressing the AUDIO button. Set “Line Audio Input” in “Audio” setup to “Main/Sub” in the Setup Display (page 102). When recording on other discs, select either sound track with the connected equipment before recording.

---

## Unrecordable pictures

Pictures with copy protection cannot be recorded on this recorder. Recording stops when a copy guard signal is detected.

Copy control signals	Recordable discs
Copy-Free	<div style="display: flex; gap: 5px;"> <div style="border: 1px solid black; padding: 2px;">+RW</div> <div style="border: 1px solid black; padding: 2px;">-RWVR</div> <div style="border: 1px solid black; padding: 2px;">-RW<sub>Video</sub></div> </div> <div style="display: flex; gap: 5px; margin-top: 2px;"> <div style="border: 1px solid black; padding: 2px;">+R</div> <div style="border: 1px solid black; padding: 2px;">-RVR</div> <div style="border: 1px solid black; padding: 2px;">-R<sub>Video</sub></div> </div>
Copy-Once <sup>*1</sup>	<div style="display: flex; gap: 5px;"> <div style="border: 1px solid black; padding: 2px;">-RWVR</div> <div>(CPRM <sup>*2</sup>)</div> </div> <div style="display: flex; gap: 5px; margin-top: 2px;"> <div style="border: 1px solid black; padding: 2px;">-RVR</div> <div>(CPRM <sup>*2</sup>)</div> </div>
Copy-Never	None

<sup>\*1</sup> Not recordable on non-CPRM compatible DVDs that are commonly available.

<sup>\*2</sup> The recorded disc can be played only on CPRM compatible equipment (page 30).

---

## Formatting a new disc

New, unformatted discs are automatically formatted when first inserted in the recorder. For DVD-RWs/DVD-Rs, you can select a recording format (VR mode or Video mode) according to your needs (page 30).

- Unused DVD-RWs are automatically formatted according to the setting of “Format DVD-RW” in “Features” setup (page 103).
- Unused DVD-Rs are automatically formatted in Video mode. To format in VR mode, change the recording format using the “Disc Setting” display (page 64).



# DVD Recording From Connected Equipment Without the Timer

+RW -RWVR -RWVideo +R -RVR -RVideo

You can record TV programs on the recorder through the connected cable box/satellite receiver.

## Note

To play a disc recorded with this recorder on other equipment, finalize the disc (page 66). If you set “Auto Finalize” to “On” in the “Features” setup (page 103), the Auto Finalize function works for DVD-RWs (Video mode), DVD-Rs (Video mode) and DVD+Rs after recording. For details, see page 67.

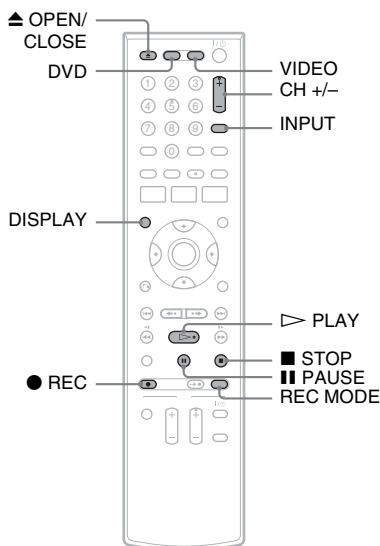

- 1 Turn on the recorder and the connected cable box/satellite receiver.
- 2 Press DVD to operate the DVD recorder.
- 3 Press ▲ OPEN/CLOSE, and place a recordable disc on the disc tray.

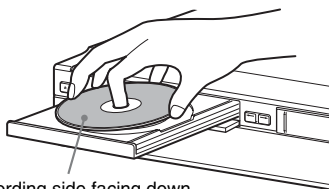

Recording side facing down

- 4 Press ▲ OPEN/CLOSE to close the disc tray.

Wait until “LOAD” disappears from the front panel display.

Unused discs are automatically formatted. For the DVD-RW/DVD-R's recording format (VR mode or Video mode), see “Formatting a new disc” on page 48.

- 5 Press CH +/- or INPUT repeatedly to select the channel or input source you want to record.

- When using the cable box/satellite receiver control, select the channel by pressing CH +/- on this recorder's remote. The recorder's input is switched to the connected input (LINE1 or LINE2). You can also use the number buttons.
- When not using the cable box/satellite receiver control, select the connected input (LINE1 or LINE2) by pressing INPUT, and then select the channel on the cable box/satellite receiver's side.

- 6 Press REC MODE repeatedly to select the recording mode.

The display changes on the TV screen as follows:

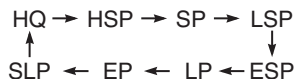

For details about the recording mode, see page 47.

- 7 Press ● REC.

Recording starts.

Recording continues until you stop the recording or the disc is full.

Leave the cable box/satellite receiver turned on and do not change the channel you are recording.

## To stop recording

Press ■ STOP.

Note that it may take a few seconds for the recorder to stop recording.

## To pause recording

Press ▬ PAUSE.

To restart recording, press ▬ PAUSE again.

## To watch a VHS tape while recording

Press VIDEO to operate the VCR, insert a tape, then press ▷ PLAY.

### Hint

You can turn off the TV during recording.

## Notes

- Recording may not start immediately after ● REC is pressed.
- You cannot change the recording mode during recording or recording pause.
- If there is a power failure, the program you are recording may be erased.
- You cannot change the input source during recording.

## Recording using the Quick Timer (One-touch Timer Recording)

You can set the recorder to record in 30-minute increments.

**1** Press DVD to operate the DVD recorder.

**2** Press ● REC repeatedly to set the duration.

Each press increases the time by 30 minutes, up to eight hours\*.

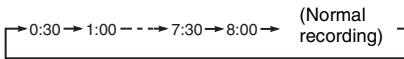

“⊖” and “OTR” light up, and the remaining recording time appears in the front panel display.

When the time counter reaches “0:00,” the recorder stops recording and turns off.

\* 14 hours 30 minutes for DVD+R DL (Double Layer) discs.

## To cancel the Quick Timer

Press ● REC repeatedly until the counter appears in the front panel display. The recorder returns to normal recording mode.

## To stop recording

Press ■ STOP twice.

Note that it may take a few seconds for the recorder to stop recording.

## Checking the disc status while recording

You can check the recording information such as recording time or disc type.

### Press DISPLAY during recording.

The information display appears.

Press the button repeatedly to change the display (page 40).

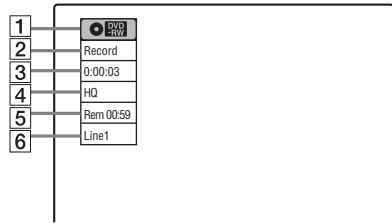

**1** Disc type

**2** Recording status

**3** Recording time

**4** Recording mode

**5** Remaining disc space

**6** Input source

### Hint

You can view the information also in the front panel display. Press TIME/TEXT repeatedly to change the display. Note that TIME/TEXT does not work during One-touch Timer Recording.

## Creating chapters in a title

The recorder will automatically divide a recording (a title) into chapters by inserting chapter marks at 5 or 15-minute intervals during recording. Select the interval, “5 Min” (default) or “15 Min” in “DVD Auto Chapter” of “Features” in the “Setup” display (page 102).

If you do not want to divide titles, select “Off.”

# DVD Timer Recording From Connected Equipment

**+RW** **-RWVR** **-RWVideo** **+R** **-RVR** **-RVideo**

You can set the timer for a total of 12 programs together with DVD and VCR timer recording, up to one month in advance.

Note that the maximum continuous recording time for a single title is 12 hours. Contents beyond this time will not be recorded.

If you record from connected equipment that has a timer function, you can use the Synchro Rec function (page 54).

## Notes

- Do not operate your cable box or satellite receiver just before or during a timer recording. This may prevent the accurate recording of a program.
- To play a disc recorded with this recorder on other equipment, finalize the disc (page 66). If you set "Auto Finalize" to "On" in the "Features" setup (page 103), the Auto Finalize function works for DVD-RWs (Video mode), DVD-Rs (Video mode) and DVD+Rs after recording. For details, see page 67.

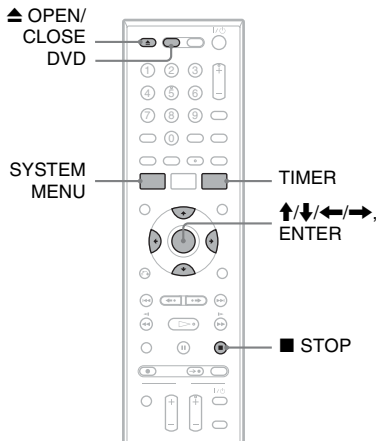

**1** Press **DVD** to operate the DVD recorder.

**2** Press **▲ OPEN/CLOSE**, and place a recordable disc on the disc tray.

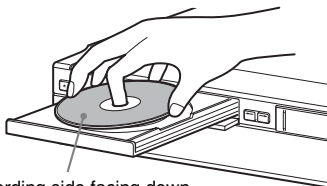

Recording side facing down

**3** Press **▲ OPEN/CLOSE** to close the disc tray.

Wait until "LOAD" disappears from the front panel display.

Unused discs are automatically formatted. For the DVD-RW/DVD-R's recording format (VR mode or Video mode), see "Formatting a new disc" on page 48.

**4** Press **TIMER**.

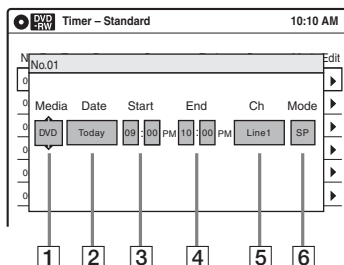

**5** Select an item using **←/→** and adjust using **↑/↓**.

**1** "Media": Select "DVD."

**2** "Date": Sets the date using **↑**.

To record the same program every day or the same day every week, press **↓**.

The item changes as follows:

Today **↔** Sun-Sat (Sunday to Saturday)

**↔** Mon-Sat (Monday to Saturday) **↔**

Mon-Fri (Monday to Friday) **↔** Sun

(every Sunday) **↔** Mon (every Monday)

**↔** ... **↔** Sat (every Saturday) **↔**

1 month later **↔** ... **↔** Today

**3** "Start": Sets the start time.

**4** "End": Sets the stop time.

- 5 “Ch”: Selects the channel or input source.
- When using the cable box/satellite receiver control, select the channel.
  - When not using the cable box/satellite receiver control, select the input, LINE1 or LINE2. Select the channel on the connected cable box/satellite receiver’s side before the timer recording starts.

- 6 “Mode”: Selects the recording mode (page 47).  
To use the Rec Mode Adjust function (page 52), select “AUTO.”

If you make a mistake, select the item and change the setting.

## 6 Press ENTER.

The Timer List menu (page 53) appears. The  indicator lights up in the front panel display, and the recorder is ready to start recording.

- If the  indicator flashes in the front panel display, check that a recordable disc is inserted and that there is enough disc space for the recording.
- If timer settings overlap, a message appears. To change or cancel a timer recording, select “Edit” from the Timer List (page 53).

## 7 Press SYSTEM MENU to turn off the menu.

There is no need to turn off the recorder before the timer recording starts.

Leave the cable box/satellite receiver turned on and do not change the channel selected on the cable box/satellite receiver until the recorder finishes the timer recording.

### To stop recording

Press  STOP twice.

Note that it may take a few seconds for the recorder to stop recording.

### If timer settings overlap

The program that starts first has priority and the second program starts recording only after the first program has finished. If the programs start at the same time, the program listed first in the menu has priority. If the end time of one setting and the start time of another timer setting is the same, the

beginning of the program that starts later will be cut.

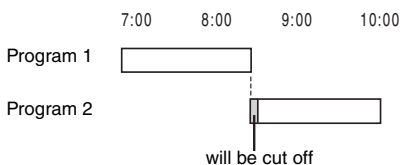
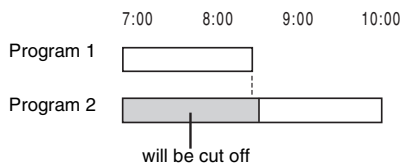

### To change or cancel timer recording

See “Changing or Canceling DVD Timer Settings (Timer List)” on page 53.

### To use the Rec Mode Adjust function

If the remaining disc space is not enough for the current recording, the recorder automatically adjusts the recording mode. Select “AUTO” for “Mode” when setting the timer.

### Hints

- You can play the recorded program by selecting the program title in the Title List menu.
- When the start time and the channel or input source to be recorded are the same but the “Media” setting differs, the program is recorded to both the DVD disc and the VHS tape.
- You can also turn on the timer programming menu from the System Menu. Press SYSTEM MENU to select “Timer,” and select “Timer-Standard.”

### Notes

- Even when correctly set, the program may not be recorded if another recording is underway, or other prioritized timer setting overlaps.
- Before the timer recording starts, “TIMER REC” flashes in the front panel display.
- The recorder automatically turns off when a timer recording finishes, even if the recording started with the recorder turned on.
- The recorder does not record programs with Copy-Never signals. Such recordings stop after a few seconds.

# Changing or Canceling DVD Timer Settings (Timer List)

+RW -RWVR -RWVideo +R -RVR -RVideo

You can change or cancel timer settings using the Timer List menu.

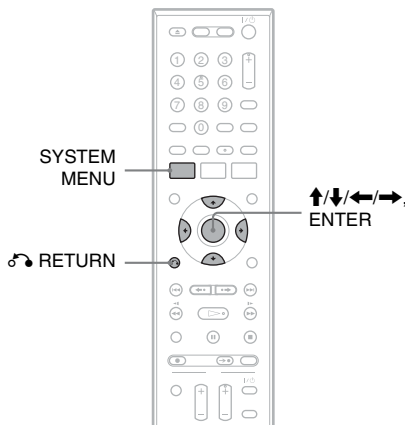

- 1 Press SYSTEM MENU.**  
The System Menu appears.
- 2 Select "Timer," and press ENTER.**
- 3 Select "Timer List," and press ENTER.**

No.	Media	Date	Start	End	Ch	Mode	Edit
01	DVD	04/15	09:00PM	10:00PM	Line1	SP	▶
02	DVD	04/30	09:15PM	09:45PM	Line1	SP	▶
03	---	--/--	--:--	--:--	----	----	▶
04	---	--/--	--:--	--:--	----	----	▶
05	---	--/--	--:--	--:--	----	----	▶
06	---	--/--	--:--	--:--	----	----	▶

Timer information displays the recording date, time, recording mode, etc.  
If there are more than six timer settings, press **↓** to display the next page.

- 4 Select the timer setting you want to change or cancel, and press ENTER.**

The sub-menu appears.

No.	Media	Date	Start	End	Ch	Mode	Edit
01	DVD	04/15	09:00PM	10:00PM	Line1	SP	Edit ▶
02	DVD	04/30	09:15PM	09:45PM	Line1	SP	Erase ▶
03	---	--/--	--:--	--:--	----	----	▶
04	---	--/--	--:--	--:--	----	----	▶
05	---	--/--	--:--	--:--	----	----	▶
06	---	--/--	--:--	--:--	----	----	▶

- 5 Select one of the options, and press ENTER.**

“Edit”: Changes the timer setting.  
Select an item using **←/→** and adjust using **↑/↓**. Press ENTER.

No.	Media	Date	Start	End	Ch	Mode	Edit
No.01	DVD	04/15	09:00 PM	10:00 PM	Line1	SP	Edit ▶

“Erase”: Erases the timer setting.  
Select “OK” and press ENTER when asked for confirmation.

No.	Media	Date	Start	End	Ch	Mode	Edit
No.01	Do you want to erase "No.01"?						▶
							OK Cancel ▶

- 6 Press SYSTEM MENU to turn off the Timer List.**

**To return to the previous display**

Press **↶** RETURN.

## Notes

- Even when correctly set, the program may not be recorded if another recording is underway, or other prioritizing timer setting overlaps. For priority, see page 52.

- You cannot change the timer settings for a recording currently underway.
- The Timer List displays both the DVD recorder and VCR timer settings.

## Recording From Connected Equipment With a Timer (Synchro Rec)

+RW -RWVR -RWVideo +R -RVR -RVideo

You can set the recorder to automatically record programs from connected equipment that has a timer function (such as a satellite tuner). Connect the equipment to the LINE 1 IN (VIDEO/AUDIO) jacks on the rear of the recorder (page 13). When the connected equipment turns on, the recorder starts recording a program from the LINE 1 IN jacks.

### Note

To play a disc recorded with this recorder on other equipment, finalize the disc (page 66).

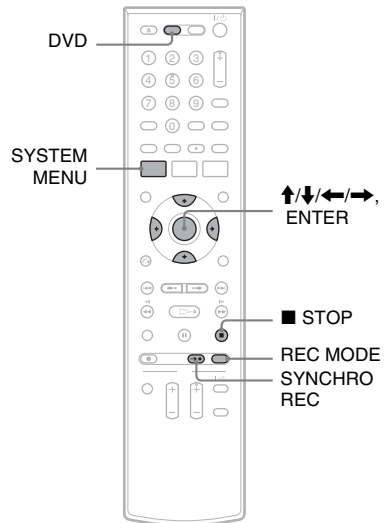

- 1** Press DVD to operate the DVD recorder.
- 2** Insert a recordable disc.
- 3** Select the line input audio.  
Set “Line Audio Input” of “Audio” setup to “Stereo” or “Main/Sub” in the “Setup” display (page 102).

#### 4 Press REC MODE repeatedly to select the recording mode.

The display changes on the TV screen as follows:

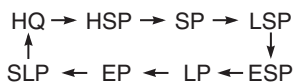

For details about the recording mode, see page 47.

#### 5 Press SYSTEM MENU while the recorder is in stop mode.

#### 6 Select “Setup,” and press ENTER.

#### 7 Select “Features,” and press ENTER.

The “Features” setup appears.

#### 8 Select “Synchro Recording,” and press ENTER.

#### 9 Select “to DVD,” and press ENTER.

#### 10 Press SYSTEM MENU to turn off the menu.

#### 11 Set the timer on the connected equipment to the time you want to record, and turn it off.

#### 12 Press SYNCHRO REC.

The SYNC-REC indicator lights up in the front panel display and the recorder stands by for Synchro-Rec.

The recorder starts recording when a signal is received from the connected equipment.

When the connected equipment turns off, the recording stops and the recorder turns off.

#### To stop recording

Press ■ STOP twice.

#### To cancel a Synchro-Rec function

Press SYNCHRO REC before recording starts. The SYNC-REC indicator turns off in the front panel display.

If you press SYNCHRO REC during Synchro-Rec, the recording stops, the SYNC-REC indicator turns off, and the recorder turns off.

#### If the timer settings of a Synchro-Recording and another timer recording overlap

Regardless of whether or not the program is a Synchro-Rec program, the program that starts first has priority. The recorder starts recording the second program about ten seconds after the first program has finished. If the end time of one setting and the start time of another timer setting is the same, the beginning of the program that starts later will be cut.

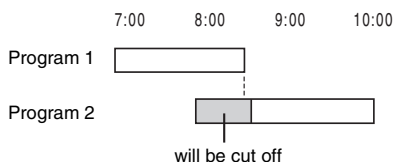

#### Notes

- The recorder starts recording only after detecting the video signal from the connected equipment. The beginning of the program may not be recorded regardless of whether or not the recorder's power is on or off.
- To use the connected equipment during Synchro-Rec standby, cancel the standby mode by pressing SYNCHRO REC. To return to standby mode again, be sure to turn off the equipment and press SYNCHRO REC, before Synchro-Rec starts.
- The Synchro-Rec function does not work with some tuners. For details, see the tuner's operating instructions.
- The Synchro-Rec function does not work for a video signal input via the LINE 1 IN S VIDEO jack.
- After a recording has finished, the recorder enters the Synchro-Rec standby mode until the SYNC-REC indicator turns off in the front panel display.
- If Synchro-Rec starts with the recorder turned on, the recorder will turn off when the recording ends.
- The recorder does not record programs with Copy-Never signals. Such recordings stop after a few seconds.

# Recording From Another VCR or Similar Device

+RW -RWVR -RWVideo +R -RVR -RVideo

You can record from a connected VCR or similar device. For connection details, see “Connecting Another VCR or Similar Device” on page 27. To record from the equipment that has a DV/D8 output jack (i.LINK jack), use the DV IN jack on the front panel. For details, see page 86. To record from a USB device connected to the USB jack, see page 89.

## Note

To play a disc recorded with this recorder on other equipment, finalize the disc (page 66). If you set “Auto Finalize” to “On” in the “Features” setup (page 103), the Auto Finalize function works for DVD-RWs (Video mode), DVD-Rs (Video mode) and DVD+Rs after recording. For details, see page 67.

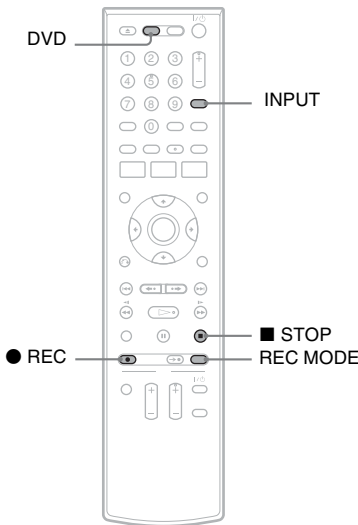

- 1 Press DVD to operate the DVD recorder.
- 2 Insert a recordable disc.

- 3 Press INPUT repeatedly to select an input source according to the connection you made.

The front panel display changes as follows:

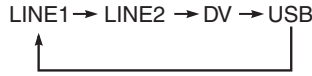

When connecting to the LINE 2 IN jacks on the front panel, select “LINE2.”

- 4 Press REC MODE repeatedly to select the recording mode.

The display changes on the TV screen as follows:

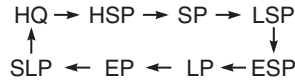

For details about the recording mode, see page 47.

- 5 Select the line input audio.

Set “Line Audio Input” of “Audio” setup to “Stereo” or “Main/Sub” in the “Setup” display (page 102).

- 6 Insert the source tape into the connected equipment and set to playback pause.

- 7 Press ● REC on this recorder and the pause or play button on the connected equipment at the same time.

Recording starts.

To stop recording, press ■ STOP on this recorder.

## Notes

- A video game image may not be recorded clearly.
- The recorder does not record programs with Copy-Never signals. Such recordings stop after a few seconds.
- During recording or recording pause, you cannot change the recording mode.
- You cannot change the input source during recording.



## Before Editing

This recorder offers various edit options for various disc types. Before you edit, check the disc type in the “Disc Information” display (page 64), and select the option available for your disc.

### Notes

- You may lose the edited contents if you remove the disc or a timer recording starts while editing.
- You cannot edit recordings on DVD-RWs (Video mode), DVD+Rs, or DVD-Rs (Video mode) recorded on other DVD equipment.

## Edit options for DVD+RWs/DVD-RWs (Video mode)/DVD+Rs/DVD-Rs (Video mode)

+RW -RW<sub>Video</sub> +R -R<sub>Video</sub>

You can perform simple edits. Since Video mode titles are actual recordings on the disc, you cannot undo any edits you make. The edit functions available for Video mode titles are:

- Renaming a title (page 61).
- Erasing a title (page 58).
- Setting protection against erasure (DVD+RWs only) (page 58).
- Erasing a section of a title (A-B Erase) (DVD+RWs only) (page 59).
- Dividing a title (DVD+RWs only) (page 60).

### Notes

- Once the disc is finalized, you cannot edit or record on the disc (except for DVD+RWs).
- If a message appears and indicates that the disc’s control information is full, erase unnecessary titles.

## Edit options for DVD-RWs (VR mode)/DVD-Rs (VR mode)

-RW<sub>VR</sub> -R<sub>VR</sub>

You can enjoy advanced edit functions. First you have two options for a DVD-RW (VR mode) and DVD-R (VR mode): editing either the original recording (called the “original”), or the playback information created from the original (called a “Playlist”). Since each is different in nature and offers different merits, read the following and select the one that better suits your needs.

### To edit original titles

Edits made to the original titles are final. If you plan to retain an unaltered original recording, create a Playlist (see below). The edit functions available for original titles are:

- Renaming a title (page 61).
- Erasing a title (page 58).
- Erasing a chapter (page 59).
- Setting protection against erasure (page 58).
- Erasing a section of a title (A-B Erase) (page 59).
- Dividing a title (page 60).

### To create Playlist titles

A Playlist is a group of Playlist titles created from the original title. When you create a Playlist, only the control information necessary for playback, such as the playback order, is stored on the disc. The original titles are left unaltered.

If you erase an original title used in a Playlist, that Playlist is also erased.

Example: You have recorded the final few matches of a soccer tournament on a DVD-RW (VR mode). You want to create a digest with the goal scenes and other highlights, but you also want to keep the original recording.

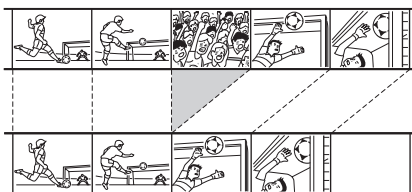

In this case, you can compile highlight scenes as a Playlist title.

## Hints

- You can switch the Title List to show original or Playlist. While the Title List menu is turned on, press ORIGINAL/PLAYLIST repeatedly.
- You can rename or erase a Playlist title (page 64).

## Notes

- You cannot protect Playlist titles.
- If a message appears and indicates that the disc's control information is full, erase unnecessary titles.
- You cannot create or edit Playlist titles on a finalized disc. When you want to edit or record on the DVD-RW again, unfinalize the disc (page 66).

## Editing a Title

+RW -RWVR -RWVideo +R -RVR -RVideo

This section explains the basic edit functions. Note that editing is irreversible. To edit a DVD-RW (VR mode) or DVD-R (VR mode) without changing the original recordings, create a Playlist title (page 62).

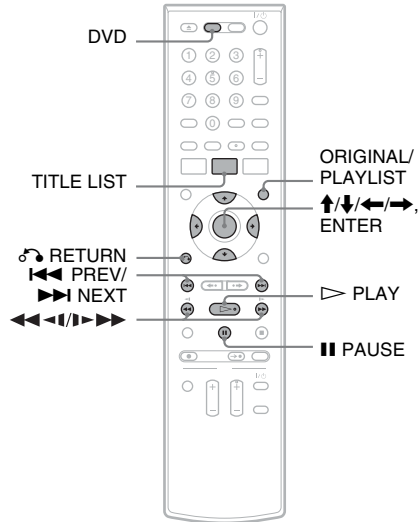

**1 Press DVD to operate the DVD recorder.**

**2 Press TITLE LIST.**

When editing a DVD-RW (VR mode) or DVD-R (VR mode), press ORIGINAL/PLAYLIST to switch to the “Title List (Original),” if necessary.

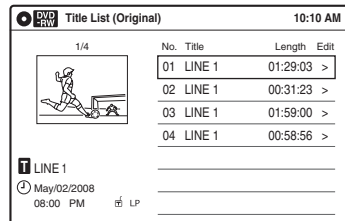

**3 Select a title, and press ENTER.**

The sub-menu appears.

## 4 Select an option, and press ENTER.

You can select from the following:  
“Title Erase”\*: Erases the selected title. Select “OK” when asked for confirmation.

“Chapter Erase”<sup>\*1</sup>: Allows you to select a chapter in the title and erase it (see below).  
“Protect”<sup>\*2</sup>: Protects the title. Select “On” when the Protection display appears. “

“Title Name”\*: Allows you to rename the title (page 61).

“A-B Erase”<sup>\*2</sup>: Erases a section of the title (see below).

“Divide Title”<sup>\*2</sup>: Divides a title into two (page 60).

\*1 DVD-RWs (VR mode) and DVD-Rs (VR mode) only

\*2 DVD+RWs, DVD-RWs (VR mode), and DVD-R (VR mode) only

## About freeing up disc space

Erasing titles, chapters, or scenes:

- frees up disc space on a DVD-RW (VR mode).
- frees up disc space on a DVD+RW/DVD-RW (Video mode) only when you erase the last title or chapter.
- cannot free up disc space on a DVD+R/DVD+R DL/DVD-R.

## Hint

You can also rename a disc (page 64).

## Notes

- When editing a DVD-RW (Video mode), DVD+R, or DVD-R, finish all editing before finalizing the disc. You cannot edit a finalized disc.
- You cannot erase protected titles or erase chapters from a protected title.
- If you erase an original title used in a Playlist, that Playlist is also erased.

## Erasing a chapter (Chapter Erase)

 -RWVR  -RVR

You can select a chapter within a title and erase it. Note that erasing chapters from original titles cannot be undone.

## 1 Press TITLE LIST.

Press ORIGINAL/PLAYLIST to switch to the “Title List (Original),” if necessary.

## 2 Select a title, and press ENTER.

The sub-menu appears.

## 3 Select “Chapter Erase,” and press ENTER.

The display for erasing chapters appears.

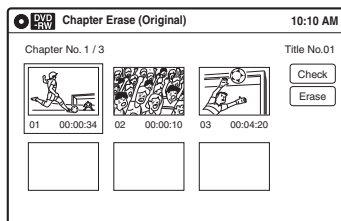

## 4 Select the chapter you want to erase, and press ENTER.

“Check” is selected. To preview the chapter, press ENTER. When playback finishes or when you press  RETURN, the display returns to “Chapter Erase (Original).”

## 5 Select “Erase,” and press ENTER.

The display asks for confirmation.

## 6 Select “OK,” and press ENTER.

The selected chapter is erased from the title. To erase other chapters, repeat from step 4.

## Note

If you erase an original title used in a Playlist, that Playlist is also erased.

## Erasing a section of a title (A-B Erase)

 +RW  -RWVR  -RVR

You can select a section (scene) within a title and erase it. Note that erasing scenes from original titles cannot be undone.

## 1 Press TITLE LIST.

When editing a DVD-RW (VR mode) or DVD-R (VR mode), press ORIGINAL/PLAYLIST to switch to the “Title List (Original),” if necessary.

## 2 Select a title, and press ENTER.

The sub-menu appears.

## 3 Select “A-B Erase,” and press ENTER.

The display for setting point A and B appears. “Start” is selected.

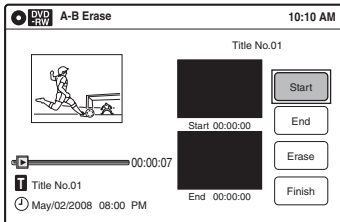

## 4 Press ENTER at the start point of the section to be erased (point A).

You can use ▷ PLAY, ◀◀◀/▶▶▶▶, ◀◀ PREV/▶▶▶ NEXT, and || PAUSE to find the point. At the point you want to select, press ▷ PLAY or || PAUSE, and press ENTER. “End” is selected.

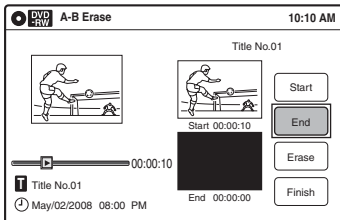

## 5 Press ENTER at the end point of the section (point B).

“Erase” is selected.

To reset the start or end point, select “Start” or “End” and repeat from step 4 or 5.

## 6 Press ENTER.

The display asks for confirmation.

## 7 Select “OK,” and press ENTER.

The scene is erased.

To continue, repeat from step 4.

To finish, select “Finish,” and press ENTER.

## Hint

A chapter mark is inserted after the scene was erased. The chapter mark divides the title into separate chapters on either side of the mark.

## Notes

- Images or sound may be momentarily interrupted at the point where you erase a section of a title.
- Sections shorter than five seconds may not be erased.
- The start and end points of a title may be different from what you have set.
- If you erase an original title used in a Playlist, that Playlist is also erased.

## Dividing a title into two (Divide Title)

+RW -RWVR -RVR

You can divide a title into two. Note that dividing original titles cannot be undone.

## 1 Press TITLE LIST.

When editing a DVD-RW (VR mode) or DVD-R (VR mode), press ORIGINAL/PLAYLIST to switch to the “Title List (Original),” if necessary.

## 2 Select a title, and press ENTER.

The sub-menu appears.

## 3 Select “Divide Title,” and press ENTER.

The display for setting the dividing point appears.

“Point” is selected.

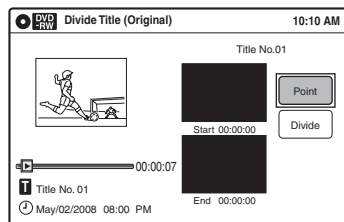

#### 4 Press ENTER at the point where you want to divide the title.

You can use ▷ PLAY, ◀◀◀/▶▶▶, ◀◀◀ PREV/▶▶▶ NEXT, and || PAUSE to find the point. At the point you want to select, press ▷ PLAY or || PAUSE, and press ENTER.

“Divide” is selected.

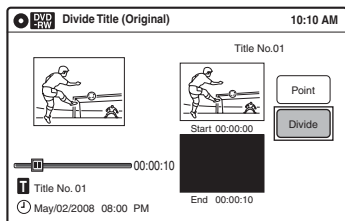

#### 5 Press ENTER.

The display asks for confirmation. To reset the dividing point, select “No” and press ENTER, then repeat from step 4.

#### 6 Select “Yes,” and press ENTER.

The display asks whether to rename the title. To use the same name as before, select “No” and press ENTER to finish.

#### 7 Select “Yes,” and press ENTER.

The “Title Name” display appears.

#### 8 Follow steps 5 to 7 of “Changing the Name of a Title” (page 61) to complete renaming.

The divided title appears in the Title List with the new name.

#### 💡 Hint

If the dividing point is set too close to the beginning of the title, the title cannot be divided.

## Changing the Name of a Title



You can enter a title name of up to 32 characters. Since the displayed number of characters is limited, their appearance in menus such as Title List may be different. When the display for entering characters appears, follow the steps below.

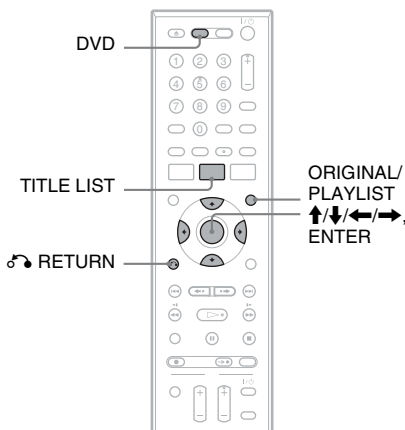

#### 1 Press DVD to operate the DVD recorder.

#### 2 Press TITLE LIST.

When editing a DVD-RW (VR mode) or DVD-R (VR mode), press ORIGINAL/PLAYLIST to switch to the “Title List (Original),” if necessary.

#### 3 Select a title, and press ENTER.

The sub-menu appears.

#### 4 Select “Title Name,” and press ENTER.

The “Title Name” display appears.

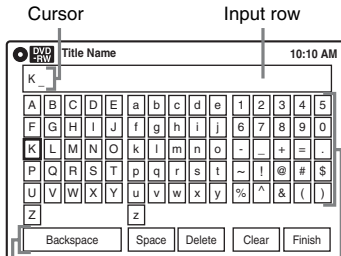

Setting buttons

Character palette

## 5 Select the character you want to enter using $\uparrow/\downarrow/\leftarrow/\rightarrow$ , and press ENTER.

The selected character appears in the input row.

You can only enter characters and symbols that are displayed.

- To change the cursor position, select the input row using  $\uparrow$ , and press  $\leftarrow/\rightarrow$ .
- To erase a character, select either of the following setting buttons and press ENTER.  
“Backspace”: Erases the character to the left of the cursor.  
“Delete”: Erases the character at the cursor position.  
“Clear”: Erases all the characters in the input row.
- To insert a space, move the cursor to the desired position, select “Space,” and press ENTER.
- To insert a character, move the cursor to the desired position, select the character, and press ENTER.

## 6 Repeat step 5 to enter the remaining characters.

To return to the Title List without renaming the title, press  $\delta$  RETURN.

## 7 Select “Finish,” and press ENTER.

### Hint

You can also rename a disc (page 64). Follow steps 5 to 7 above when the “Disc Name” display appears.

# Creating a Playlist

**-RWVR** **-RVR**

Playlist titles allow you to edit without changing the original recordings (see “Edit options for DVD-RWs (VR mode)/DVD-Rs (VR mode)” on page 57). You can create a Playlist title by combining up to 99 sections (scenes) from original titles.

### Notes

- If you erase an original title used in a Playlist, that Playlist is also erased.
- You cannot create or edit Playlist titles on a finalized disc. When you want to edit or record on the DVD-RW again, unfinalize the disc (page 66).

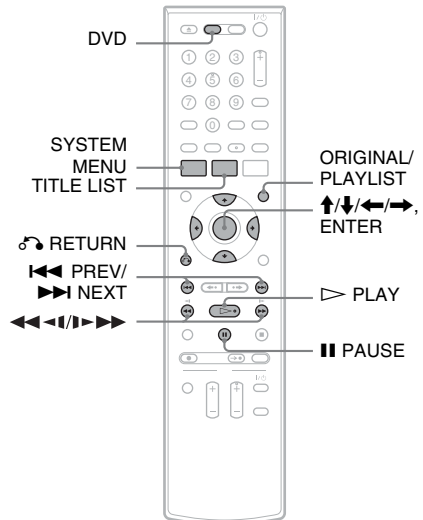

**1** Press DVD to operate the DVD recorder.

**2** Press SYSTEM MENU while the recorder is in stop mode.

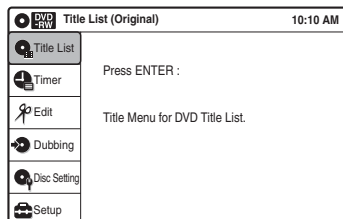

### 3 Select “Edit,” and press ENTER.

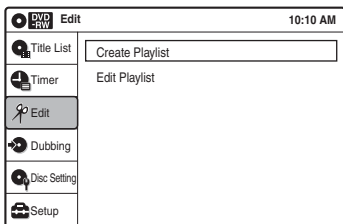

### 4 Select “Create Playlist,” and press ENTER.

The display for creating a Playlist appears. “Start” is selected.

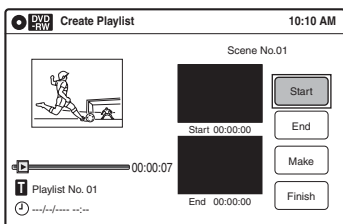

### 5 Press ENTER at the start point.

You can use  $\triangleright$  PLAY,  $\lll$  PREV/ $\ggg$  NEXT, and  $\parallel$  PAUSE to find the point. At the point you want to select, press  $\triangleright$  PLAY or  $\parallel$  PAUSE, and press ENTER.

“End” is selected.

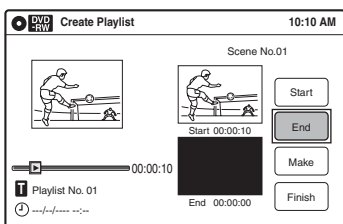

### 6 Press ENTER at the end point.

“Make” is selected.

To reset the start or end point, select “Start” or “End” and repeat step 5 or 6.

### 7 Press ENTER.

The selected section is captured as a scene. To continue, repeat from step 5.

### 8 When you finish capturing scenes, select “Finish” and press ENTER.

To return to the previous display

Press  $\circlearrowleft$  RETURN.

To turn off the display

Press SYSTEM MENU.

## Playing a Playlist title

### 1 Press TITLE LIST.

### 2 Press ORIGINAL/PLAYLIST to switch to the “Playlist” Title List.

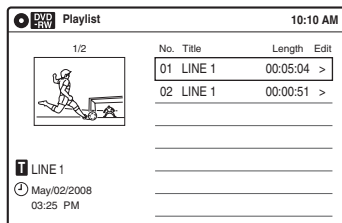

### 3 Select a Playlist title, and press ENTER.

The sub-menu appears.

### 4 Select “Play,” and press ENTER.

#### Hint

When a Playlist title is created, the start and end points will become chapter marks, and each scene will become a chapter.

#### Notes

- The picture may pause when an edited scene is played.
- The start and end points in a title may be different from what you have set.

## Renaming and erasing a Playlist title

- 1 Press **TITLE LIST**.
- 2 Press **ORIGINAL/PLAYLIST** to switch to the “Playlist” Title List.

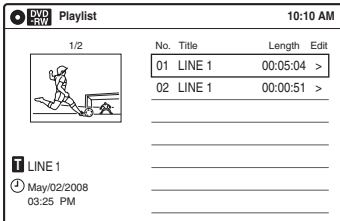

- 3 Select a **Playlist title**, and press **ENTER**.  
The sub-menu appears.
- 4 Select an **option**, and press **ENTER**.  
Select from the following options.  
“Title Erase”: Erases the title. Select “OK” when asked for confirmation.  
“Title Name”: Allows you to rename the title (page 61).

### Hint

You can also edit Playlist titles from the System Menu. Press **SYSTEM MENU** to select “Edit,” and select “Edit Playlist.”

### Note

You cannot create or edit Playlist titles on a finalized disc. When you want to edit or record on the DVD-RW again, unfinalize the disc (page 66).

## Formatting/Renaming/Protecting a Disc

**+RW** **-RWVR** **-RWVideo** **+R** **-RVR** **-RVideo**

The “Disc Setting” display allows you to check the disc information or change the disc name. Depending on the disc type, you can also format or set protection.

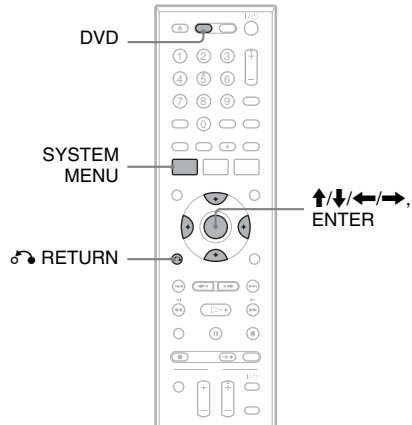

- 1 Press **DVD** to operate the DVD recorder.
- 2 Press **SYSTEM MENU** while the recorder is in stop mode.
- 3 Select “**Disc Setting**,” and press **ENTER**.  
The “Disc Setting” display appears.

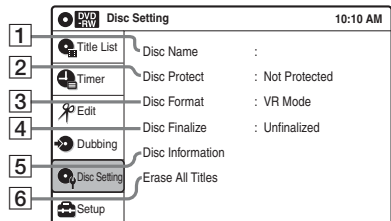

- 4 Select an **option**, and press **ENTER**.

- 1 “**Disc Name**”: Allows you to rename a disc.  
For details on how to enter characters, see page 61.



**2** “Disc Protect” (DVD+RWs/DVD-RWs (VR mode)/DVD-Rs (VR mode) only): Protects all titles on the disc when “Protected” is selected. To cancel the protection, select “Not Protected.”

**3** “Disc Format” (DVD+RWs/DVD-RWs/DVD-Rs only): Erases all contents of the disc, including protected titles, and makes a blank disc (except DVD-Rs).

For DVD-RWs, select a recording format (“VR Mode” or “Video Mode”) according to your needs.

To format unused DVD-Rs in VR mode, select “VR Mode” and then “OK.”

**4** “Disc Finalize”: Finalizes a disc. See page 66 for details.

**5** “Disc Information”: Displays the following information.

- Disc name
- Disc type (and recording format for a DVD-RW (VR mode)/DVD-R (VR mode))
- Total number of titles
- Protect setting
- The oldest and most recent recording date
- The total available recording time in each recording mode

DVD+RW Disc Information		10:10 AM	
Disc Name	Disc 1		
Media	DVD-RW	Format	VR Mode
Title No.	Original 6 / Playlist 1		
Protected	Not Protected		
Date	4/05/2008 ~ 4/30/2008		
Remainder	HQ : 0H 57M LSP : 2H 23M EP : 5H 46M	HSP : 1H 26M ESP : 2H 52M SLP : 7H 40M	SP : 1H 55M LP : 3H 50M 4.4/4.7GB

**6** “Erase All Titles” (DVD+RWs/DVD-RWs/DVD-Rs (VR mode) only): Erases all titles on the disc (except protected titles). Select “OK” when asked for confirmation.

For DVD-RWs (VR mode)/DVD-Rs (VR mode), Playlist titles created with protected titles are also erased.

## To return to the previous display

Press  RETURN.

## Hints

- You can set protection for individual titles (page 58).
- By reformatting, you can change the recording format on DVD-RWs, or record again on DVD-RWs (Video mode) that have been finalized.

## Notes

- You can label a disc using up to 32 characters; however, the name may not display on other DVD equipment.
- You cannot label an unused DVD-R (Video mode) disc. Label the disc after you first record on it.
- You cannot mix VR mode and Video mode on the same DVD-RW or DVD-R.
- You cannot change the recording format on used DVD-Rs.
- The recorder records on new DVD-Rs in Video mode unless you first format the discs in VR mode (page 48).

# Finalizing a Disc (Preparing a Disc for Playback on Other Equipment)

**+RW** **-RWVR** **-RWVideo** **+R** **-RVR** **-RVideo**

Finalizing is necessary in order to play discs recorded with this recorder on other DVD equipment. Note that you cannot further record or edit on a finalized disc.

When you finalize a DVD+RW/DVD-RW (Video mode)/DVD+R/DVD-R (Video mode), a DVD menu will be automatically created, which can be displayed on other DVD equipment.

Before finalizing, check the differences between the disc types in the table below.

## Differences between the disc types

**+RW** Discs are automatically finalized when removed from the recorder. You can edit or record on the disc even after finalizing.

**-RWVR** Finalizing is unnecessary when playing a disc on VR format compatible equipment. Even if your other DVD equipment is VR format compatible, you may need to finalize the disc, especially if the recording time is short. After finalizing, you cannot edit or record on it again. If you want to edit or record on it again, unfinalize or reformat the disc (page 64). Note however, that reformatting a disc erases all its contents.

**-RWVideo** Finalizing is necessary in order to play on equipment other than this recorder. After finalizing, you cannot edit or record on the disc. If you want to edit or record on it again, unfinalize or reformat the disc (page 64). Note however, that reformatting a disc erases all its contents.

**-RVR** Finalizing is necessary in order to play on equipment other than this recorder. The finalized discs can be played on other VR mode compatible players. After finalizing, you cannot further edit or record on the disc.

**+R** Finalizing is necessary in order to play on equipment other than this recorder.

**-RVideo** After finalizing, you cannot further edit or record on the disc.

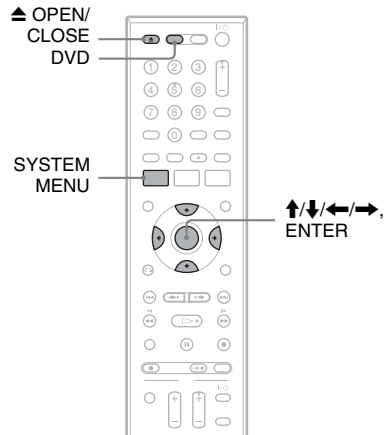

- 1 Press DVD to operate the DVD recorder.
- 2 Insert a disc.
- 3 Press SYSTEM MENU while the recorder is in stop mode.  
The System Menu appears.
- 4 Select "Disc Setting," and press ENTER.  
The "Disc Setting" display appears.

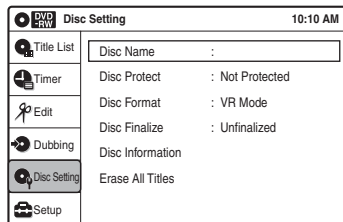

- 5 Select "Disc Finalize," and press ENTER.  
The display asks for confirmation.

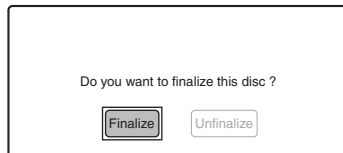

- 6 Select “Finalize,” and press ENTER.**  
The display asks for confirmation again.



- 7 Select “OK,” and press ENTER.**  
The recorder starts finalizing the disc.

### To turn off the display

Press SYSTEM MENU.

### To unfinalize a DVD-RW

If you cannot record or edit on a DVD-RW that has been finalized, unfinalize the disc by selecting “Unfinalize” in step 6 above.

#### Hints

- You can check whether the disc has been finalized or not. If you cannot select “Finalize” in step 6 above, the disc has already been finalized.
- To check the disc information, select “Disc Information” in the “Disc Setting” display and press ENTER. See page 64 for details.

#### Notes

- Depending on the condition of the disc, the recording, or the DVD equipment, discs may not play even if the discs are finalized.
- The recorder may not be able to finalize a disc if it was recorded on another recorder.

## Using the Auto Finalize function

**-RW<sub>Video</sub> +R -R<sub>Video</sub>**

If the recording exceeds 30 % of the disc capacity, the recorder automatically finalizes DVD-RWs (Video mode), DVD-Rs (Video mode), and DVD+Rs:

- when you eject the disc by pressing **▲ OPEN/CLOSE** immediately after you stop recording by pressing **■ STOP**.
  - when all the timer recordings are finished.
  - if the disc becomes full during recording.
- To turn on this function, set “Auto Finalize” to “On” in the “Features” setup (page 103).

#### Notes

- It may take a few minutes for the recorder to finalize a disc.
- A disc once finalized cannot be recorded or edited.
- DVD-Rs (Vidoe mode)/DVD+Rs cannot be unfinalized.
- For discs where erasing titles/chapters does not free up disc space (page 59), the Auto Finalize function activates if the total amount of recording before erasing exceeds 30 % of the disc capacity.
- The Auto Finalize function does not work for One-touch Timer Recording (page 50) or Synchro-Recording (page 54).

## Playing a VHS Tape

VHS

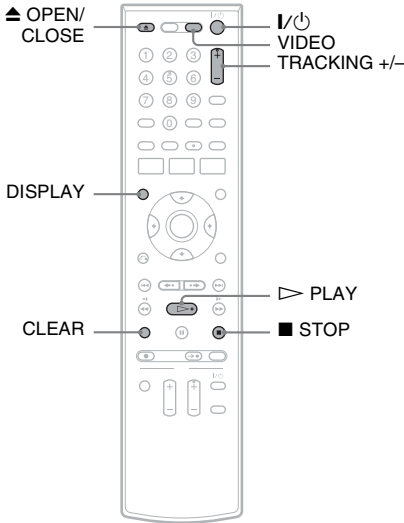

**1 Press VIDEO to operate the VCR.**

**2 Insert a tape.**

Playback starts automatically if you insert a tape with its safety tab removed.

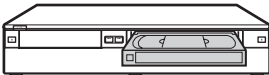

**3 Press ▷ PLAY.**

The front panel display shows the playing time.

When the tape reaches the end, it will rewind automatically.

### To stop playback

Press ■ STOP.

### To eject the tape

Press ▲ OPEN/CLOSE.

### To turn off the power while rewinding (Rewind Shut Off)

Press I/⏻ while the tape is rewinding. The power will turn off but the tape will keep rewinding until it reaches the end.

### To use the time counter

Press CLEAR at the point where you want to find later. The counter in the front panel display resets to "0:00:00."

To search for the 0:00:00 point automatically, see page 71.

To display the counter on the TV screen, press DISPLAY.

### Notes

- During playback, the VCR automatically detects the recording system (S-VHS/VHS) and the recording mode (SP or EP) from the tape. LP mode recordings made on other equipment will play, but picture quality is not guaranteed.
- The counter resets to "0:00:00" whenever a tape is reinserted.
- The counter stops counting when it comes to a portion with no recording.
- The counter resets to "0:00:00" after ten hours, and starts recounting.
- When playback does not start even if you insert a tape with its safety tab removed, set "VCR Function" – "Auto Play" of "Features" to "On" in the "Setup" display (page 103).
- If you switch to the VCR while playing a disc, DVD playback stops.
- The VCR does not record in S-VHS format, but will play S-VHS tapes by automatically detecting the format, but picture quality will be lower than usual S-VHS. Image may be unclear if playback options such as slow-motion, etc., are used.
- Playback of S-VHS tapes recorded in EP (×3) mode is not guaranteed.
- The VCR is not compatible with the PAL or SECAM color system. Only NTSC tapes can be played.
- For simultaneous VHS and DVD operation, see page 9.

---

## Adjusting the picture (tracking)

You can manually adjust tracking if the recording quality is too poor to be remedied by the VCR's automatic tracking (a tracking meter appears during the automatic tracking).

### Press TRACKING +/-.

The tracking meter appears.  
Press TRACKING +/- repeatedly until the distortion disappears.

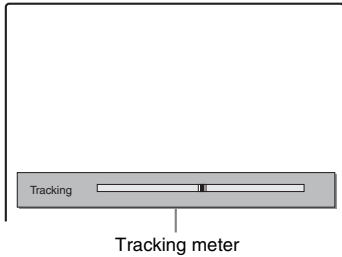





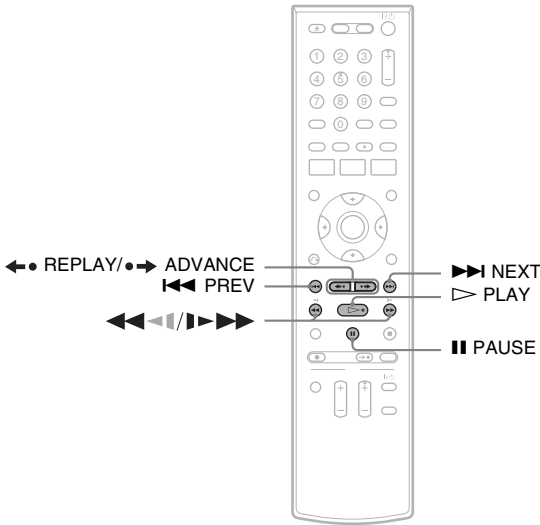

---

### To resume automatic tracking

Press TRACKING + and TRACKING - on the recorder at the same time for more than ten seconds. Or, eject the tape and reinsert it.

# Playback Options

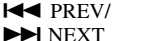

Button	Operation
 (fast reverse/fast forward)	<ul style="list-style-type: none"> <li>• Fast reverses or fast forwards when pressed during stop mode.</li> <li>• When you hold down during fast reverse or fast forward, you can view the picture.</li> <li>• Plays at high speed when briefly pressed during playback.</li> <li>• When you hold down the button during playback, the high-speed play continues until you release the button.</li> </ul>
 (slow)	Plays in slow motion when pressed in pause mode.
 ADVANCE	<ul style="list-style-type: none"> <li>• Advances one frame for each press in pause mode.</li> <li>• Fast forwards the current scene for 30 seconds when pressed during playback.*1</li> </ul>
 REPLAY	Replays the previous scene when pressed during playback.*2
 PREV/ NEXT	Press during playback. Playback speed changes with each press: -x7 ↔ -x5 ↔ -x3 ↔ PAUSE ↔ SLOW ↔ PLAY ↔ x2 ↔ x3 ↔ x5 ↔ x7
 PAUSE	Pauses playback. If you pause playback for more than five minutes, playback starts automatically.

\*1 Can be pressed up to four times to forward about two minutes.

\*2 For 10 seconds in SP or LP mode/for 15 seconds in EP mode.

## Notes

- The sound is muted during playback at various speeds.
- The picture may show noise during high-speed reverse play.

To resume normal playback, press  PLAY.

# Searching Using Various Functions

## VHS

The VCR automatically marks the tape with an index signal at the point where each recording begins.

You can easily find a specific point using various search functions.

### Note

During DVD recording, you cannot use VCR search functions.

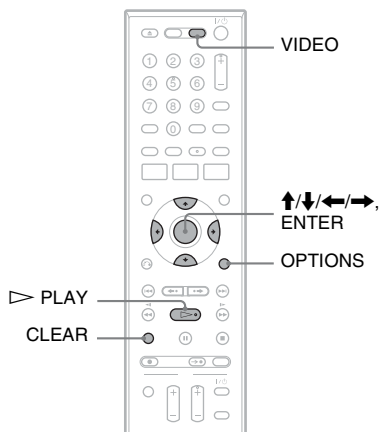

- 1 Press VIDEO to operate the VCR.
- 2 Press OPTIONS.
- 3 Select a search method from the OPTIONS menu, and press ENTER.

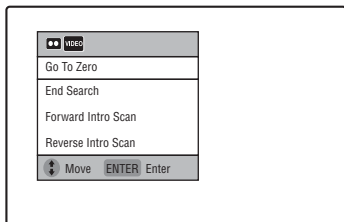

“Go To Zero”: Searches for the 0:00:00 point on the tape counter.  
To reset the counter to 0:00:00, press CLEAR.

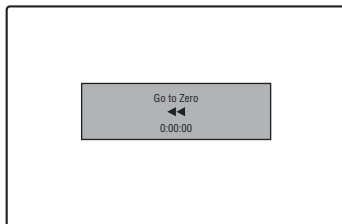

“End Search”: Searches for the beginning of a blank space. If no blank space is found, the tape will reach the end.

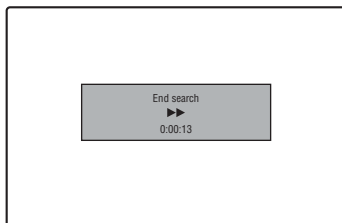

“Forward Intro Scan”/“Reverse Intro Scan”: Searches for an index mark and plays back for about five seconds at that point. Press ▷ PLAY to view that program. If you do not press ▷ PLAY, the VCR automatically searches for the next index mark, or until it reaches the end of the tape.



### Notes

- The VCR may not recognize the end of a blank space depending on its length.
- No index signal is marked if you pause a recording and then keep recording the same program. To mark an index, press ■ STOP or change the input source once during recording pause.

# Displaying the Playing Time and Play Information

## VHS

You can check playback information, such as elapsed or remaining time, recording mode, etc., on the TV screen.

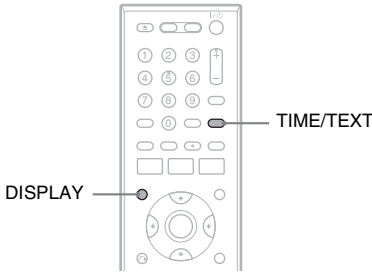

### Press DISPLAY during playback.

The information display appears. Each time you press the button, the display changes as follows:

- Tape and disc information/date and time
- ↓
- Tape information only
- ↓
- No display

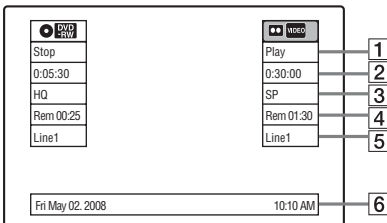

- 1 Playing status
- 2 Time counter (elapsed time)
- 3 Recording mode
- 4 Remaining tape length
- 5 Input source
- 6 Date and time

# Viewing information on the front panel display

You can view the information on the front panel display.

### Press TIME/TEXT repeatedly.

The displays differ depending on the status.

Example: When playing a tape

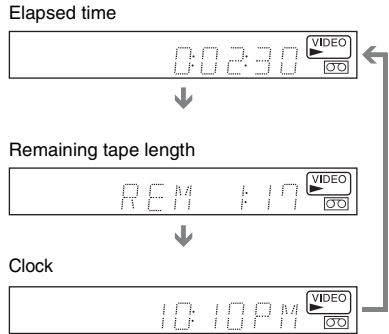

Example: When a tape is in stop mode

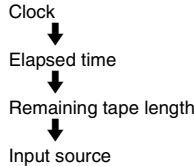



# Selecting the Sound During Playback

VHS

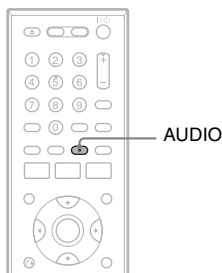

Press **AUDIO** repeatedly during playback.

To listen to	On-screen display
Stereo	Hi-Fi
Left channel	Left
Right channel	Right
Monaural sound on the normal audio track	Mono

## How sound is recorded on a video tape

The VCR records sound onto two separate tracks. Hi-fi audio is recorded onto the main track along with the picture. Monaural sound is recorded onto the normal audio track along the edge of the tape.

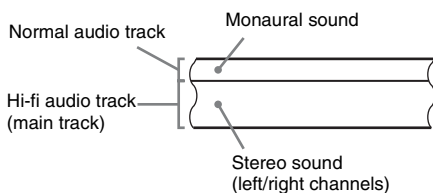

## Notes

- To play a tape in stereo, you must use the A/V connections.
- When you play a tape recorded in monaural, the sound is heard in monaural regardless of the AUDIO setting.

# Before Recording

### Before you start recording...

- This VCR records in VHS format, not S-VHS format.
- Check that the tape is longer than the recording time (page 72).
- Check that the recorder is connected to a tuner such as a cable box or satellite receiver (page 12). See also the tuner's instruction manual.

### Notes

- Timer recordings will start with or without the recorder turned on. Once started, the recorder cannot be turned off. The recorder automatically turns off after a recording has finished.
- This recorder has the copy guard function. Programs that contain a Copy-Never copy guard signal cannot be correctly recorded on the VCR.

### To save a recording

To prevent accidental erasure, break off the safety tab as illustrated. To record on the tape again, cover the tab hole with adhesive tape.

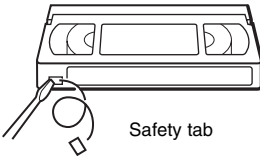

## Recording mode

“EP” (Extended Play) and “SP” (Standard Play) is available for recording mode (tape speed). “EP” provides recording time three times as long as “SP.” However, “SP” produces better picture and audio quality.

### Maximum recording time

Tape Length	SP	EP
T-120	2 hrs	6 hrs
T-160	2 hrs 40 mins	8 hrs
T-180	3 hrs	9 hrs

### Notes

- Tapes recorded in EP (×3) mode by this VCR cannot be played back on VHS video decks with SP mode only.
- Noise may appear in the image when tapes recorded in EP (×3) mode by this VCR are played back on other VHS video decks with EP mode.

# VCR Recording From Connected Equipment Without the Timer

VHS

You can record TV programs on the recorder through the connected cable box/satellite receiver.

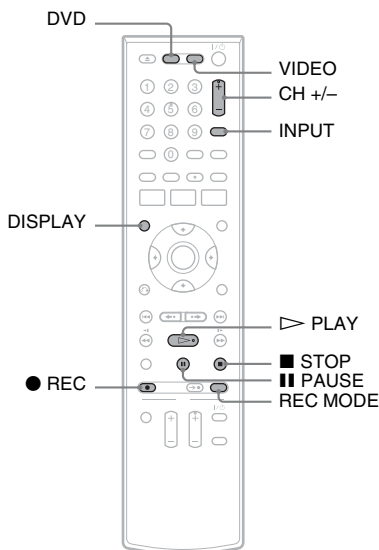

- 1 Turn on the recorder and the connected cable box/satellite receiver.
- 2 Press VIDEO to operate the VCR.
- 3 Insert a tape with its safety tab in place.

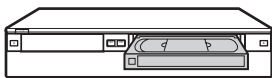

- 4 Press CH +/- or INPUT repeatedly to select the channel or input source you want to record.
  - When using the cable box/satellite receiver control, select the channel by pressing CH +/- on this recorder's remote. The recorder's input is switched to the connected input (LINE1 or LINE2). You can also use the number buttons.
  - When not using the cable box/satellite receiver control, select the connected input

(LINE1 or LINE2) by pressing INPUT, and then select the channel on the cable box/satellite receiver's side.

- 5 Press REC MODE repeatedly to select the recording mode, "SP" or "EP."

For details about the recording mode, see page 74.

- 6 Press ● REC.

"REC" appears in the front panel display, and recording starts.

Leave the cable box/satellite receiver turned on and do not change the channel you are recording.

## To stop recording

Press ■ STOP.

## To pause recording

Press ▬ PAUSE.

To restart recording, press ▬ PAUSE again.

If you pause recording for more than five minutes, recording stops automatically.

## To watch a DVD while recording

Press DVD to operate the DVD recorder, insert a disc, and press ▷ PLAY.

## Hints

- Tape information displayed on the TV screen will not be recorded on the tape.
- You can turn off the TV during recording.

## Notes

- You cannot change the recording mode or input source while recording.
- If you insert a tape with its safety tab removed, the tape is ejected when you press ● REC.

## Recording using the Quick Timer (One-touch Timer Recording)

You can set the recorder to record in 30-minute increments.

- 1 Press VIDEO to operate the VCR.
- 2 Press ● REC repeatedly to set the duration.

Each press increases the time by 30 minutes, up to six hours.

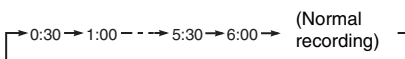

“⊖” and “OTR” light up, and the remaining recording time appears in the front panel display.

When the time counter reaches “0:00,” the recorder stops recording and turns off.

## Notes

- The remaining tape length may not be indicated accurately for short tapes such as T-20 or T-30, or tapes recorded in LP mode.
- After DISPLAY is pressed, it may take one minute for the remaining tape length to appear.

### To cancel the Quick Timer

Press ● REC repeatedly until the counter appears in the front panel display. The recorder returns to normal recording mode.

### To stop recording

Press ■ STOP twice.

## Checking the remaining tape length

You can check recording information, such as remaining tape length or recording mode, etc.

### Press DISPLAY while recording.

The information display appears.

Press the button repeatedly to change the display (page 72).

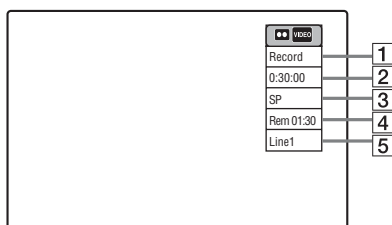

- 1 Recording status
- 2 Time counter
- 3 Recording mode
- 4 Remaining tape length
- 5 Input source

To check the remaining tape length, set “VCR Function” – “Tape Length” of “Features” in the “Setup” display correctly (page 103).

### Hint

You can view the information also in the front panel display. Press TIME/TEXT repeatedly to change the display. Note that TIME/TEXT does not work during One-touch Timer Recording.

# VCR Timer Recording From Connected Equipment

## VHS

You can set the timer for a total of 12 programs together with DVD and VCR timer recording, up to one month in advance.

If you record from connected equipment that has a timer function, you can use the Synchro Rec function (page 80).

### Note

Do not operate your cable box or satellite receiver just before or during a timer recording. This may prevent the accurate recording of a program.

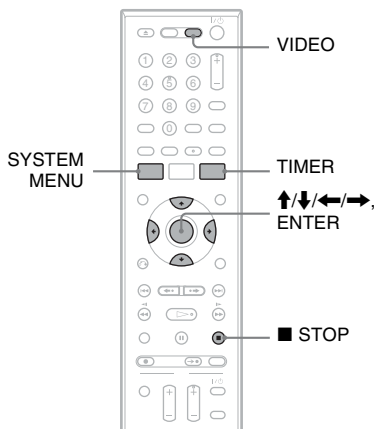

- 1 Press VIDEO to operate the VCR.
- 2 Insert a tape with its safety tab in place.

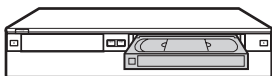

## 3 Press TIMER.

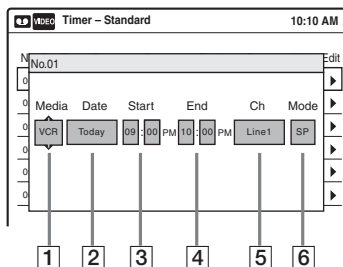

## 4 Select an item using ←/→ and adjust using ↑/↓.

- 1 "Media": Select "VCR."
- 2 "Date": Sets the date using ↑.  
To record the same program every day or the same day every week, press ↓.  
The item changes as follows:  
Today ↔ Sun-Sat (Sunday to Saturday) ↔  
Mon-Fri (Monday to Friday) ↔ Sun  
(every Sunday) ↔ Mon (every Monday) ↔  
... ↔ Sat (every Saturday) ↔  
1 month later ↔ ... ↔ Today
- 3 "Start": Sets the start time.
- 4 "End": Sets the stop time.
- 5 "Ch": Selects the channel or input source.
  - When using the cable box/satellite receiver control, select the channel.
  - When not using the cable box/satellite receiver control, select the input, LINE1 or LINE2. Select the channel on the connected cable box/satellite receiver's side before the timer recording starts.
- 6 "Mode": Selects the recording mode; "SP" or "EP." To use the Rec Mode Adjust function (page 78), select "AUTO."

If you make a mistake, select the item and change the setting.

## 5 Press ENTER.

The Timer List menu (page 79) appears. The ⊕ indicator lights up in the front panel display, and the recorder is ready to start recording.

- If the ⊖ indicator flashes in the front panel display, check that a tape with its safety tab in place is inserted.
- If timer settings overlap, a message appears. To change or cancel a timer recording, select “Edit” from the Timer List (page 79).

## 6 Press SYSTEM MENU to turn off the menu.

There is no need to turn off the recorder before the timer recording starts.

Leave the cable box/satellite receiver turned on and do not change the channel selected on the cable box/satellite receiver until the recorder finishes the timer recording.

### To stop recording

Press ■ STOP twice.

### If timer settings overlap

The program that starts first has priority and the second program starts recording only after the first program has finished. If the programs start at the same time, the program listed first in the menu has priority. If the end time of one setting and the start time of another timer setting is the same, the beginning of the program that starts later will be cut.

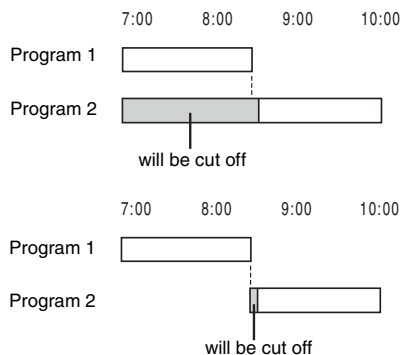

### To change or cancel timer recording

See “Changing or Canceling VCR Timer Settings (Timer List)” on page 79.

### To use the Rec Mode Adjust function

If the remaining tape length is too short for the current recording, the VCR automatically changes the recording mode from SP to EP.

When setting the timer, select “AUTO” in “Mode,” and check that the “Tape Length” setting is correct for the inserted tape (“VCR Function” -

“Tape Length” of “Features” in the “Setup” display (page 103)).

### Hints

- When the start time and the channel or input source to be recorded are the same but the “Media” setting differs, the program is recorded to both the DVD disc and the VHS tape.
- You can also turn on the Timer programming menu from the System Menu. Press SYSTEM MENU to select “Timer,” and select “Timer-Standard.”

### Notes

- Even when correctly set, the program may not be recorded if another recording is underway, or other prioritized timer setting overlaps.
- You cannot record on a tape with its safety tab removed.
- Before the timer recording starts, “TIMER REC” flashes in the front panel display.
- The recorder automatically turns off when a timer recording finishes, even if the recording started with the recorder turned on.

# Changing or Canceling VCR Timer Settings (Timer List)

## VHS

You can change or cancel timer settings using the Timer List menu.

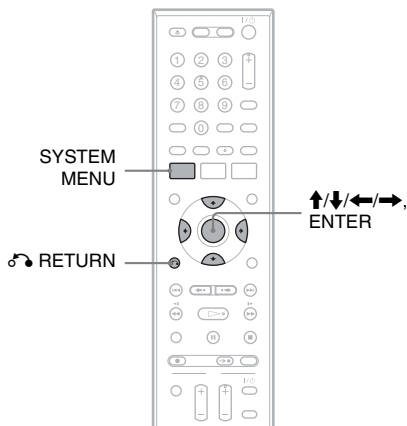

- 1 Press SYSTEM MENU.**  
The System Menu appears.
- 2 Select "Timer," and press ENTER.**
- 3 Select "Timer List," and press ENTER.**

No.	Media	Date	Start	End	Ch	Mode	Edit
01	VCR	04/15	09:00PM	10:00PM	Line1	SP	▶
02	VCR	04/30	09:15PM	09:45PM	Line1	SP	▶
03	---	--/--	--:--	--:--	----	----	▶
04	---	--/--	--:--	--:--	----	----	▶
05	---	--/--	--:--	--:--	----	----	▶
06	---	--/--	--:--	--:--	----	----	▶

Timer information displays the recording date, time, recording mode, etc.

If there are more than six timer settings, press **↓** to display the next page.

- 4 Select the timer setting you want to change or cancel, and press ENTER.**

The sub-menu appears.

No.	Media	Date	Start	End	Ch	Mode	Edit
01	VCR	04/15	09:00PM	10:00PM	Line1	SP	▶
02	VCR	04/30	09:15PM	09:45PM	Line1	SP	▶
03	---	--/--	--:--	--:--	----	----	▶
04	---	--/--	--:--	--:--	----	----	▶
05	---	--/--	--:--	--:--	----	----	▶
06	---	--/--	--:--	--:--	----	----	▶

- 5 Select one of the options, and press ENTER.**

“Edit”: Changes the timer setting.

Select an item using **←/→** and adjust using **↑/↓**. Press ENTER.

No.	Media	Date	Start	End	Ch	Mode	Edit
No.01	VCR	04/15	09:00PM	10:00PM	Line1	SP	▶

“Erase”: Erases the timer setting.

Select “OK” and press ENTER when asked for confirmation.

No.	Media	Date	Start	End	Ch	Mode	Edit
Do you want to erase "No.01"?							
OK				Cancel			

- 6 Press SYSTEM MENU to turn off the Timer List.**

**To return to the previous display**

Press **RETURN**.

## Notes

- Even when correctly set, the program may not be recorded if another recording is underway, or other prioritizing timer setting overlaps. For priority, see page 78.

- You cannot change the timer settings for a recording currently underway.
- The Timer List displays both the DVD recorder and VCR timer settings.

## Recording From Connected Equipment With a Timer (Synchro Rec)

### VHS

You can set the recorder to automatically record programs from connected equipment that has a timer function (such as a satellite tuner). Connect the equipment to the LINE 1 IN (VIDEO/AUDIO) jacks on the rear of the recorder (page 13). When the connected equipment turns on, the recorder starts recording a program from the LINE 1 IN jacks.

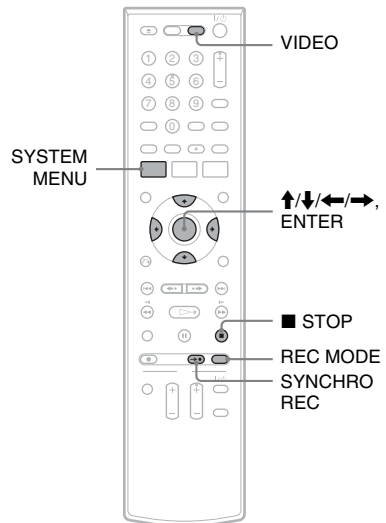

- 1** Press VIDEO to operate the VCR.
- 2** Insert a tape with its safety tab in place.
- 3** Press REC MODE repeatedly to select the recording mode, "SP" or "EP."
- 4** Press SYSTEM MENU while the recorder is in stop mode.
- 5** Select "Setup," and press ENTER.
- 6** Select "Features," and press ENTER.  
The "Features" setup appears.
- 7** Select "Synchro Recording," and press ENTER.



- 8 Select "to VIDEO," and press ENTER.
- 9 Press SYSTEM MENU to turn off the menu.
- 10 Set the timer on the connected equipment to the time of the program you want to record, and turn it off.
- 11 Press SYNCHRO REC.

The SYNC-REC indicator lights up in the front panel display and the recorder stands by for Synchro-Rec.

The recorder starts recording when a signal is received from the connected equipment.

When the connected equipment turns off, the recording stops and the recorder turns off.

### To stop recording

Press ■ STOP twice.

### To cancel Synchro-Rec function

Press SYNCHRO REC before recording starts.

The SYNC-REC indicator turns off in the front panel display.

If you press SYNCHRO REC during Synchro-Rec, the recording stops, the SYNC-REC indicator turns off, and the recorder turns off.

### If the timer settings of a Synchro-Recording and another timer recording overlap

Regardless of whether or not the program is a Synchro-Rec program, the program that starts first has priority and the second program starts recording only after the first program has finished. If the end time of one setting and the start time of another timer setting is the same, the beginning of the program that starts later will be cut.

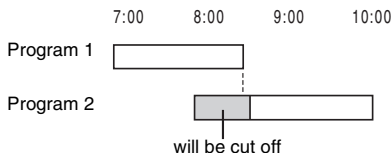

### Notes

- The recorder starts recording only after detecting the video signal from the connected equipment. The beginning of the program may not be recorded regardless of whether or not the recorder's power is on or off.
- To use the connected equipment during Synchro-Rec standby, cancel the standby mode by pressing SYNCHRO REC. To return to standby mode again, be sure to turn off the equipment and press SYNCHRO REC, before Synchro-Rec starts.
- The Synchro-Rec function does not work with some tuners. For details, see the tuner's operating instructions.
- The Synchro-Rec function does not work for a video signal input via the LINE 1 IN S VIDEO jack.
- After a recording has finished, the recorder enters the Synchro-Rec standby mode until the SYNC-REC indicator turns off in the front panel display.
- You cannot record on a tape with its safety tab removed.
- If Synchro-Rec starts with the recorder turned on, the recorder will turn off when the recording ends.

# Recording From Another VCR or Similar Device

VHS

You can record from a connected VCR or similar device. For connection details, see “Connecting Another VCR or Similar Device” on page 27.

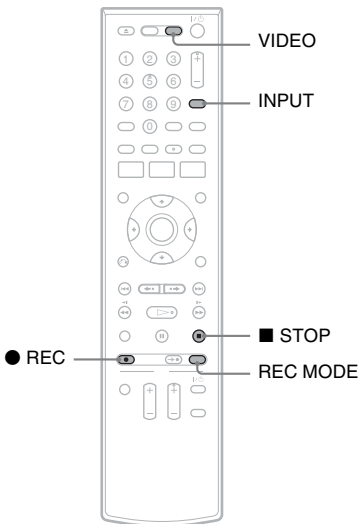

## Notes

- A video game image may not be recorded clearly.
- You cannot record on a tape with its safety tab removed.
- During recording or recording pause, you cannot change the recording mode.
- You cannot change the input source during recording.

- 1** Press VIDEO to operate the VCR.
- 2** Insert a tape with its safety tab in place.
- 3** Press INPUT repeatedly to select the input source (LINE1 or LINE2) according to the connection you made.
- 4** Press REC MODE repeatedly to select the recording mode, “SP” or “EP.”
- 5** Insert the source tape into the connected equipment and set to playback pause.
- 6** Press ● REC on this recorder and the pause or play button on the connected equipment at the same time.

Recording starts.

To stop recording, press ■ STOP on this recorder.

## Dubbing (TAPE ↔ DVD)

# Dubbing From a VHS Tape to a DVD

**+RW** **-RWVCR** **-RWVideo** **+R** **-RVR** **-RVideo**  
**VHS**

You can easily record (dub) a VHS tape to a disc. Before dubbing, make the necessary audio settings on the VCR.

### ◆How titles and chapters are created

The recorder takes each recording on the VHS tape and automatically divides them into titles as they are dubbed to a disc. These titles are then further divided into chapters at either 5 or 15-minute intervals, according to the “DVD Auto Chapter” setting of “Features” in the “Setup” display.

### Note

To play the dubbed disc on other DVD equipment, finalize the disc (page 66). If you set “Auto Finalize” to “On” in the “Features” setup (page 103), the Auto Finalize function works for DVD-RWs (Video mode), DVD-Rs (Video mode) and DVD+Rs after dubbing. For details, see page 67.

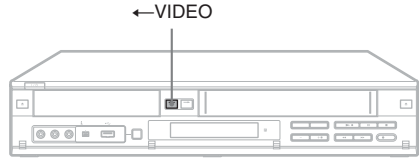
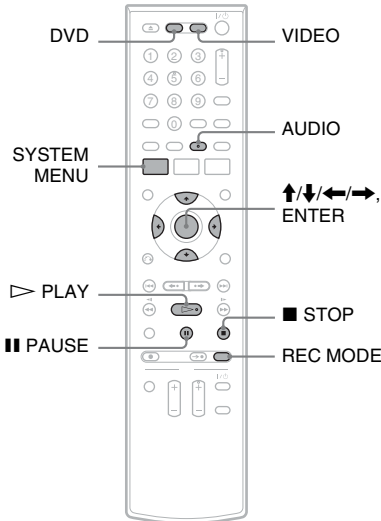

- 1 Press DVD and insert a recordable disc.**  
To select the recording mode, press REC MODE repeatedly (see page 47).
- 2 Insert a source VHS tape.**
- 3 Press VIDEO to operate the VCR.**
- 4 Start playing the VHS tape, and then press ■ STOP or || PAUSE at the point where you want to start dubbing.**  
To select VCR sound, press AUDIO during playback (see page 73).
- 5 Press ← VIDEO on the recorder.**  
Dubbing starts.

### To stop dubbing

Press ■ STOP.

Note that it may take a few seconds for the recorder to stop dubbing.

### To dub using the on-screen menu

- After step 4 above, press SYSTEM MENU.
- Select “Dubbing” from the System Menu, and press ENTER.

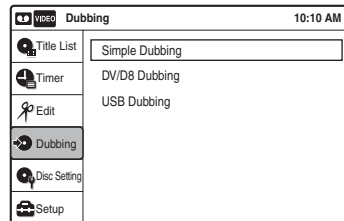

- 3 Select “Simple Dubbing,” and press ENTER.

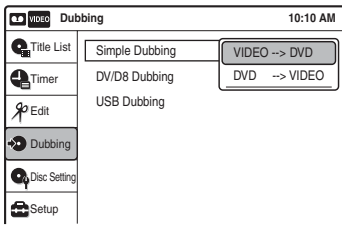

- 4 Select “VIDEO → DVD,” and press ENTER. The display asks for confirmation.
- 5 Select “Yes,” and press ENTER. Dubbing starts.

### Hints

- A black (no signal) screen at the end of the dubbed disc is not a malfunction. This screen is recorded if a time discrepancy exists between the disc and tape when the recording is stopped.
- When dubbing a VHS tape to a DVD, the VHS tape counter value may differ slightly from the DVD recording time.
- VCR playback sound is output during dubbing.

### Notes

- Dubbing cannot be made when:
  - using a non-recordable DVD.
  - using VHS software with copy guard functions.
- Dubbing stops when:
  - the VHS tape reaches the end and stops.
  - the VHS video deck or the DVD deck is stopped.
  - the disc remaining time runs out.
- The System Menu, OPTIONS menu, and information display are not displayed during dubbing.
- Copyrights
  - Recordings made from VHS tapes and other copyrighted material are solely for individual enjoyment, and other unauthorized use is prohibited under copyright law.
  - Unauthorized editing of copyrighted material is prohibited under copyright law.

## Dubbing From a DVD to a VHS Tape



You can record (dub) a DVD title to a VHS tape. Note that when you record copy-protected software to a tape, picture may appear disrupted when you play back the tape. Before dubbing, make the necessary audio settings on the DVD recorder.

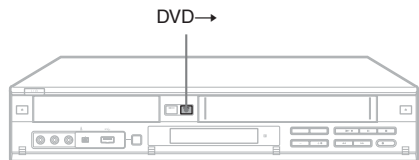
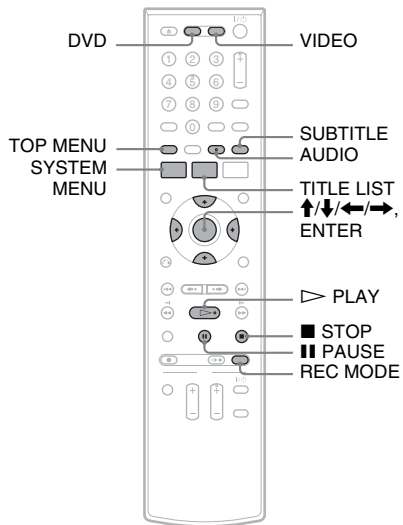

- 1 Press VIDEO and insert a VHS tape with its safety tab in place. To select the recording mode, SP or EP, press REC MODE repeatedly (see page 74).
- 2 Insert a source disc.
- 3 Press DVD to operate the DVD recorder.

**4** Press **TOP MENU** or **TITLE LIST** to select a title.

**5** Start playing the DVD, and then press **■ STOP** or **|| PAUSE** at the point where you want to start dubbing.

To select DVD sound, language, or subtitle, press **AUDIO** or **SUBTITLE** during playback (see page 35).

**6** Press **DVD** → on the recorder.

Dubbing starts.

### To stop dubbing

Press **■ STOP**.

Note that it may take a few seconds for the recorder to stop dubbing.

### To dub using the on-screen menu

**1** After step 5 above, press **SYSTEM MENU**.

**2** Select “Dubbing” from the System Menu, and press **ENTER**.

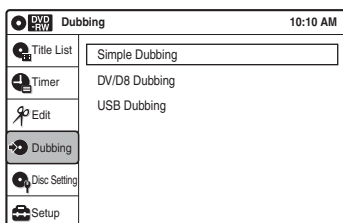

**3** Select “Simple Dubbing,” and press **ENTER**.

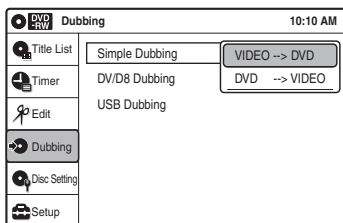

**4** Select “DVD → VIDEO,” and press **ENTER**. The display asks for confirmation.

**5** Select “Yes,” and press **ENTER**.

Dubbing starts.

If the disc’s menu appears when DVD playback finishes, press **■ STOP** to stop dubbing. Otherwise the disc’s menu is recorded until the tape reaches its end.

### Hints

- The brightness of the playback picture may differ from normal DVD playback picture.
- The DVD playback time may differ slightly from the VHS tape counter value.
- The sound being played back (main, sub, etc.) is the dubbed sound.

### Notes

- Dubbing stops when:
  - the DVD is played back to the end and stops.
  - the DVD deck or the VHS video deck is stopped.
  - the tape remaining time runs out.
- The System Menu, **OPTIONS** menu, and information display are not displayed during dubbing.
- Copyrights
  - Recordings made from discs and other copyrighted material are solely for individual enjoyment, and other unauthorized use is prohibited under copyright law.
  - Unauthorized editing of copyrighted material is prohibited under copyright law.

## Before DV/D8 Dubbing

This section explains dubbing with a DV camcorder via the DV IN jack on the front panel. If you want to dub by way of the LINE IN jacks, see “Recording From Another VCR or Similar Device” on page 56.

### About the DV IN jack

The DV IN jack on this recorder conforms to the i.LINK standard. You can connect any other equipment that has an i.LINK (DV) jack, and record digital signals. For more information about i.LINK, see “About i.LINK” on page 115.

#### Hint

If you plan to do additional editing on a disc after the initial dub, use the DV IN jack and record on a DVD-RW (VR mode) or DVD-R (VR mode). Note that erasing unwanted scenes does not free up disc space for DVD-Rs (VR mode).

#### Notes

- The DV IN jack is for input only. It will not output signals.
- You cannot use the DV IN jack when:
  - your DV camcorder does not work with this recorder.
  - Connect the camcorder to the LINE IN jack and follow the instructions of “Recording From Another VCR or Similar Device” on page 56.
  - the input signal is not in DVC-SD format. Do not connect a MICROMV format DV camcorder even if it has an i.LINK jack.
  - the input signal is in HDV (1080i) format.
  - the images on the tape contain copy protection signals, which limit recording.

## Connecting a DV Camcorder to the DV IN Jack

You can connect a DV camcorder to the DV IN jack on the recorder to record or edit from a DV/D8 format tape. Operation is straightforward because the DVD recorder will fast forward and rewind the tape for you – you do not need to operate your DV camcorder.

Refer to the instruction manual supplied with the DV camcorder as well before connecting.

VCR-DVD recorder

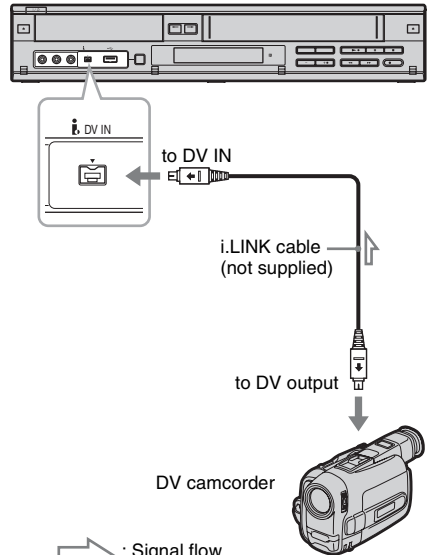

# Dubbing From a DV/D8 Format Tape to a DVD

+RW -RWVR -RVideo +R -RVR -RVideo

You can simply record the entire contents of a DV/D8 format tape onto a disc. The recorder controls the DV camcorder for the whole process. You can also select the scenes on the tape using the on-screen display. See “Dubbing selected scenes” on page 88.

## ◆How titles and chapters are created

The dubbed contents on the disc become one title, and the title is then divided into chapters at either 5 or 15-minute intervals, according to the “DVD Auto Chapter” setting of “Features” in the “Setup” display.

## Notes

- To play the dubbed disc on other DVD equipment, finalize the disc (page 66). If you set “Auto Finalize” to “On” in the “Features” setup (page 103), the Auto Finalize function works for DVD-RWs (Video mode), DVD-Rs (Video mode) and DVD+Rs after dubbing. For details, see page 67.
- Do not connect the  (USB) jack at the same time.

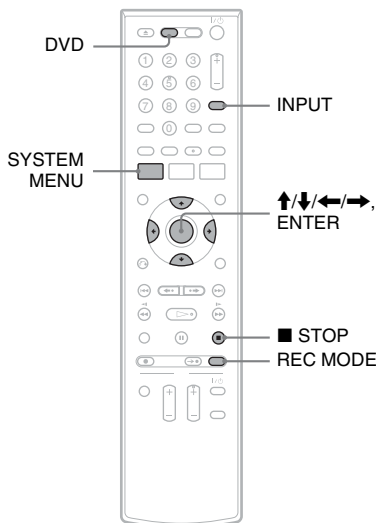

ONE-TOUCH DUBBING

- 1 Press DVD to operate the DVD recorder.**
- 2 Place a recordable disc on the disc tray.**  
About inserting discs, see page 49 for details.
- 3 Insert the source DV/D8 format tape into your DV camcorder, and set the camcorder to video playback mode.**
- 4 Press INPUT repeatedly to select “DV.”**
- 5 Press REC MODE repeatedly to select the recording mode.**
- 6 Set the “DV/D8 Audio Input” setting in the “Audio” setup (page 102).**  
Select the desired audio if multiple audio channels are recorded on the tape.
- 7 Press ONE-TOUCH DUBBING on the recorder.**

The recorder rewinds the tape in the DV camcorder and then starts recording the tape contents from the beginning. When playback of the tape stops, One Touch Dubbing ends automatically.

## To stop recording

Press  STOP.

Note that it may take a few seconds for the recorder to stop recording.

## Notes

- During dubbing, timer recordings are unavailable.
- You cannot record the date, time, or contents of a DV/D8 format tape onto the disc.
- If you record from a DV/D8 format tape with a soundtrack that is recorded in multiple sampling frequencies (48 kHz, 44.1 kHz, or 32 kHz), no sound, or an unnatural sound may be output when passing the sampling frequency switch point on the disc.
- The recorded picture may be momentarily affected if the picture size of the source image changes, or if there is nothing recorded on the tape.
- Noise may occur if you switch the audio sampling mode (48 kHz/16 bits → 32 kHz/12 bits).

## Dubbing selected scenes

You can fast forward, rewind, play in slow motion, and stop the tape to select scenes using the on-screen display.

- 1 Follow steps 1 to 6 of “Dubbing From a DV/D8 Format Tape to a DVD” (page 87).
- 2 Select “Dubbing” on the System Menu, and press ENTER.

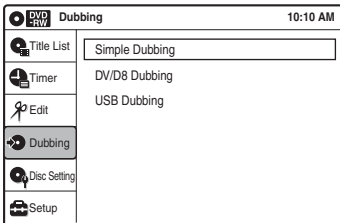

- 3 Select “DV/D8 Dubbing,” and press ENTER.

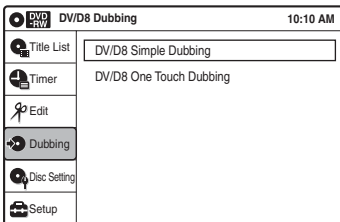

- 4 Select “DV/D8 Simple Dubbing,” and press ENTER.

The “DV Tape Mode” display appears.

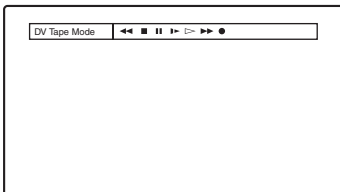

If “DV” or “DV Camera Mode” is displayed, check that the DV camcorder is correctly connected, turned on, and set to the video playback mode.

- 5 Find the dubbing start point on the tape, and stop or pause playback.

Press ◀/▶ to select ◀, ■, ■■, ▶▶, ▷, or ▶▶ on the TV screen and press ENTER to find the point, and stop or pause with ■ or ■■.

- 6 Press → to select ● on the TV screen, and press ENTER.

Dubbing starts.

### To stop recording

Select ■ on the TV screen, and press ENTER.

Note that it may take a few seconds for the recorder to stop recording.

### To turn off the display for DV/D8 dubbing

Press INPUT.

#### 💡 Hint

If “DV Camera Mode” appears on the screen, you can use ● on the TV screen to record the camera image directly on the recorder.



## Before USB Dubbing

This section explains the following dubbing methods via the USB jack:

- Dubbing all the video contents of the connected DVD camcorder to make a backup DVD (page 90).
- Dubbing the selected video contents of the connected HDD camcorder to a DVD (page 91).
- Copying JPEG image files to a DVD (page 93).

### ◆ Connectable USB devices (as of January 2008)

The following Sony devices can be connected to this recorder:

DVD camcorder: DCR-DVD108

HDD camcorder: DCR-SR42

Digital still camera: DSC-W200/T100/T20/W80/W90/H7/H9/G1

### 💡 Hint

If your HDD camcorder has no USB jack, use the Handycam Station supplied with the camcorder.

### Notes

- During dubbing, do not disconnect the USB device.
- USB cables exclusive for supplying power cannot be used.
- Connect the camcorder or digital still camera directly to the recorder, not via a USB hub or other USB device.
- Do not connect the DV IN jack at the same time.

## Connecting to the USB jack

You can connect a USB device (DVD camcorder, HDD camcorder, digital still camera, etc.) to the USB jack on the recorder.

Also refer to the instruction manual supplied with the connected USB device before connecting.

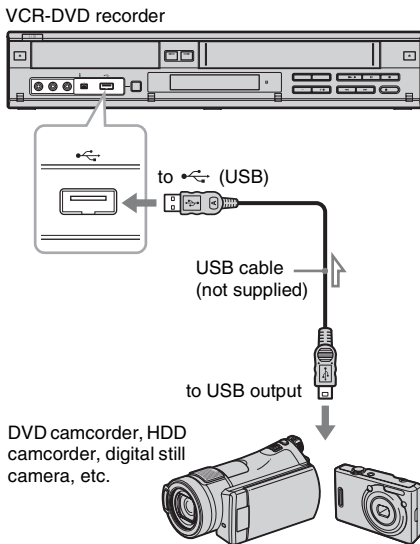

➤ : Signal flow

- 1 Turn on the recorder and the USB device.**
- 2 Connect the USB device to the (USB) jack on the recorder.**
- 3 Set your USB device to the USB connecting mode, if necessary.**

As an example for the HDD camcorder:  
When “USB SELECT” appears on the camcorder’s screen, select “COMPUTER.”

As an example for the digital still camera:  
Before connection, make sure that the USB mode of digital still camera is “Mass Storage.”  
You can not use “PictBridge” mode for connecting to this recorder.

For details, refer to the operating instructions supplied with the connected USB device.

# Dubbing From a DVD Camcorder (DVD Backup)

+RW -RWVR -RW<sub>video</sub> +R -R<sub>video</sub>

You can dub all the contents of a DVD in the DVD camcorder to another DVD as a backup copy. Be sure to finalize a source DVD before dubbing.

## ◆ Usable discs for backup DVDs

Use a new or blank DVD of the same type as the source DVD.

Source DVD (8 cm)	Recordable DVD (12 cm)
DVD+RW	DVD+RW
DVD-RW (Video mode)	DVD-RW
DVD-RW (VR mode)	DVD-RW
DVD-R (Video mode)	new DVD-R
DVD+R DL	new DVD+R

## Notes

- When using a DVD+R/DVD-R, make sure that the disc is new, unformatted, and has not been loaded into the recorder. Since blank discs are automatically formatted once loaded, you can use them for other purposes, such as timer recording.
- When using a DVD+RW/DVD-RW, use unused or blank discs only, as the operation erases any pre-recorded data.
- Insert the disc only after step 5 when the disc tray has opened. Otherwise the recorder may automatically format the disc, making it unusable for DVD Backup.

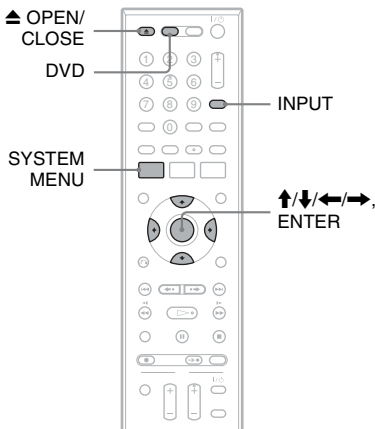

ONE-TOUCH DUBBING

- 1 Press DVD to operate the DVD recorder.
- 2 Press INPUT repeatedly to select “USB.”
- 3 Connect your DVD camcorder and set it to USB connecting mode.

For example, select “COMPUTER” when “USB SELECT” appears on the camcorder’s screen.

Check the USB indicator lights up in the front panel display.

- 4 Press ONE-TOUCH DUBBING on the recorder.

The display asks for confirmation. Note that you cannot stop dubbing halfway.

- 5 Select “Start” and press ENTER.

The disc tray opens.

- 6 Place a recordable disc, and press ▲ OPEN/CLOSE to close the disc tray.

The progress bar display appears, and the recorder starts dubbing the entire contents of the source DVD.

Do not disconnect the USB cable while dubbing is in progress. When dubbing is complete, the progress bar disappears.

## To dub using the on-screen menu

- 1 After step 3 above, press SYSTEM MENU.
- 2 Select “Dubbing,” and press ENTER.

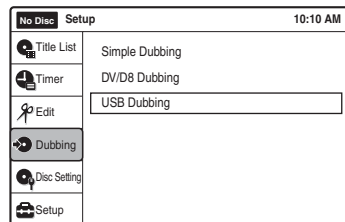

- 3 Select “USB Dubbing,” and press ENTER.

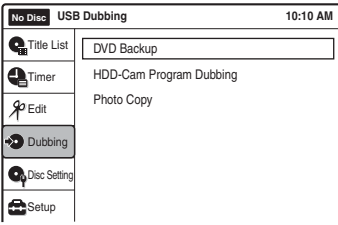

- 4 Select “DVD Backup,” and press ENTER. The display asks for confirmation.
- 5 Select “Start,” and press ENTER. The disc tray opens.
- 6 Place a recordable disc, and press ▲ OPEN/ CLOSE to close the disc tray. Dubbing starts.

#### 💡 Hint

To play the dubbed disc, press INPUT repeatedly to select the recorder’s input (LINE1 or LINE2).

#### Note

During dubbing, timer recordings are unavailable. If the timer is set during dubbing, the timer setting is canceled.

## Dubbing From a HDD Camcorder (Program Dubbing)



You can dub the selected movie files from a HDD camcorder onto a recordable DVD+RW, DVD-RW (Video mode), DVD-R (Video mode), or DVD+R.

#### ◆How titles and chapters are created

The dubbed contents on the disc become one title, and the title is then divided into chapters at either 5 or 15-minute intervals, according to the “DVD Auto Chapter” setting of “Features” in the “Setup” display.

#### Note

To play the dubbed disc on other DVD equipment, finalize the disc (page 66).

If you set “Auto Finalize” to “On” in the “Features” setup (page 103), the Auto Finalize function works for DVD-RWs (Video mode), DVD-Rs (Video mode) and DVD+Rs after dubbing. For details, see page 67.

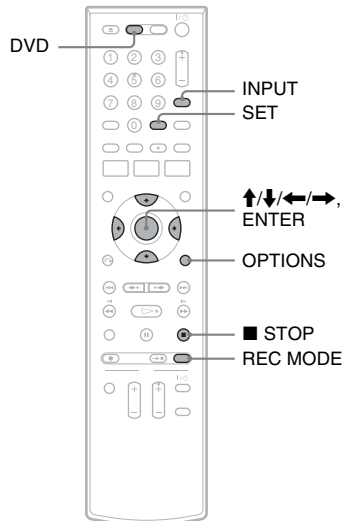



ONE-TOUCH DUBBING

- 1 Press DVD to operate the DVD recorder.**
- 2 Place a recordable disc on the disc tray.**  
About inserting discs, see page 49 for details.
- 3 Press REC MODE repeatedly to select the recording mode.**
- 4 Press INPUT repeatedly to select "USB."**
- 5 Connect your HDD camcorder and set it to USB connecting mode.**  
For example, select "COMPUTER" when "USB SELECT" appears on the camcorder's screen.  
Check the USB indicator lights up in the front panel display.

- 6 Press ONE-TOUCH DUBBING on the recorder.**

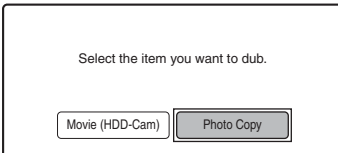

- 7 Select "Movie (HDD-CAM)," and press ENTER.**  
The contents on the HDD camcorder are listed.

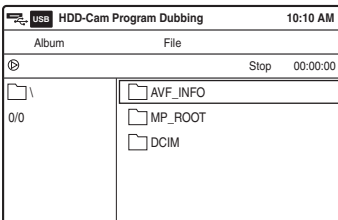

- 8 Select an album (folder) and press ENTER.**  
The movie file list appears.

- 9 Select the movie file to dub, and press SET.**

A number indicating the order in which you selected the file appears.  
Repeat the step to select all the movie files you want to dub. You can select up to 9 files.

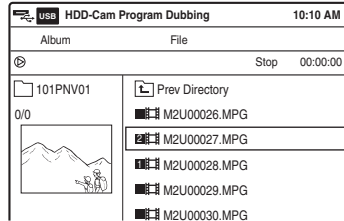

- 10 Press OPTIONS.**

The display asks for confirmation.

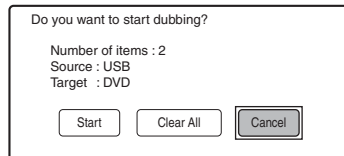

To return to the previous display, select "Cancel."

To cancel all selections, select "Clear All" and return to step 9.

- 11 Select "Start," and press ENTER.**

Playback starts from the first selected movie file, and dubbing starts.

### To stop dubbing

Press ■ STOP.

Note that it may take a few seconds for the recorder to stop dubbing.

### To add dubbing to the same disc

The recorder cannot dub more than 9 movie files at a time. To dub more files, repeat from step 5 above.

## Hints

- You can also start dubbing from the System Menu. Press SYSTEM MENU to select “Dubbing,” and select “USB Dubbing.” Select “HDD-Cam Program Dubbing” and follow steps from 7 above.
- The recorder can dub movie files that are recorded with an HDD camcorder and have the extension “.MPG.”
- You cannot dub movie files recorded with a digital still camera.
- To play the dubbed disc, press INPUT repeatedly to select the recorder’s input (LINE1 or LINE2).

## Notes

- During dubbing, timer recordings are unavailable. If the timer is set during dubbing, the timer setting is canceled.
- Movie files exceeding the disc capacity cannot be dubbed.
- Movie files larger than 2 GB will be divided into two files or more on the movie file selection screen. For example, when a movie is HQ mode and longer than 30 min, it may be divided into two or more files. When playing titles, picture and sound will stop at the end of each title, then start playback again.
- Movie and image files cannot be dubbed together in a single disc.

# Copying JPEG Image Files From a Connected Digital Still Camera

-RW<sub>Video</sub> -R<sub>Video</sub>

You can simply copy all albums containing JPEG image files from a digital still camera or HDD camcorder onto a DVD-RW (Video mode)/DVD-R (Video mode).

You can also select the albums using the on-screen menu. See “Copying the selected albums” on page 94.

## Notes

- Use unused or blank discs for copying. You cannot use a disc containing titles recorded with this recorder. You can add photos to the remaining space on the disc you used for copying photos with this recorder.
- The disc will be recognized as a DATA DVD after Photo Copy, and can be played on other DVD devices capable of JPEG playback if you finalize it (page 66). However, note that a DATA DVD may be unrecognizable, depending on the device.
- The Auto Finalize function (page 67) does not work for copying photos.

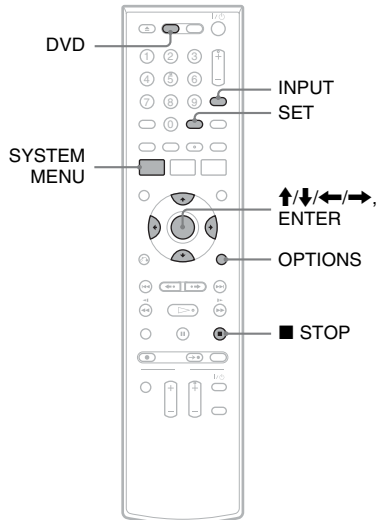

USB Dubbing (USB → DVD)

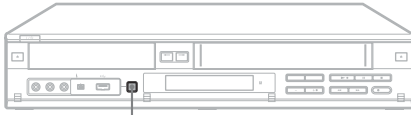

ONE-TOUCH DUBBING

- 1 Press DVD to operate the DVD recorder.**
- 2 Place a recordable disc on the disc tray.**  
About inserting discs, see page 49 for details.
- 3 Press INPUT repeatedly to select "USB."**
- 4 Connect the USB device to the  (USB) jack on the recorder.**  
Check that the USB indicator lights up on the front panel display. If not, check the operating instructions supplied with the connected device.
- 5 Press ONE-TOUCH DUBBING on the recorder.**

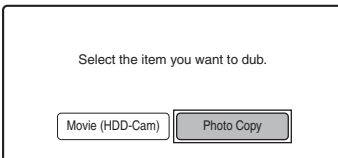

- 6 Select "Photo Copy," and press ENTER.**  
The display asks for confirmation.
- 7 Select "Start" and press ENTER.**  
The recorder starts dubbing all the albums in the connected USB device.

### To stop copying

Press ENTER to cancel.  
Note that it may take a few seconds for the recorder to stop copying.

### Hint

To play the copied disc, press INPUT repeatedly to select the recorder's input (LINE1 or LINE2).

### Notes

- Do not disconnect the USB cable while accessing to the USB device (reading or copying files).
- The recorder can copy up to 254 albums, and up to 499 files within a single album. It may take more than 30 minutes for the recorder to copy many files at one time. However, this is not a malfunction.
- Do not turn off the connected device while copying, as a malfunction may result.
- While copying, timer recordings are unavailable. If the timer is set while copying, the timer setting is canceled.
- You cannot record video titles on a disc pre-recorded with photos. If a timer recording is due to start, replace with a recordable disc.
- Up to seven layers of folders stored in the device can be copied. The folders are copied in two layers on the disc and the folder names will be changed by adding \_01, \_02, and so on, if they conflict with other names.

### Copying the selected albums

You can select the albums using the on-screen menu, and dub them all at once.

- 1 Follow the steps 1 to 4 above.**
- 2 Press SYSTEM MENU.**  
The System Menu appears.
- 3 Select "Dubbing," and press ENTER.**

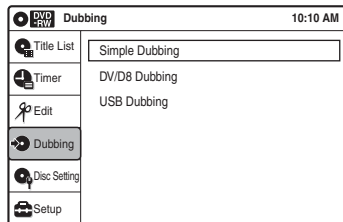

- 4 Select "USB Dubbing," and press ENTER.**

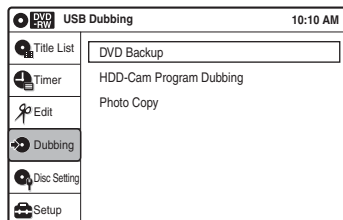

## 5 Select “Photo Copy,” and press ENTER.

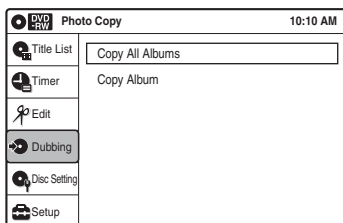

If you copy all the albums, select “Copy All Albums” and go to step 8.

## 6 Select “Copy Album,” and press ENTER.

The album list appears.

To view image files contained in the album, select the album and press ENTER.

## 7 Press $\uparrow/\downarrow/\leftarrow/\rightarrow$ to select the album to copy, and press SET.

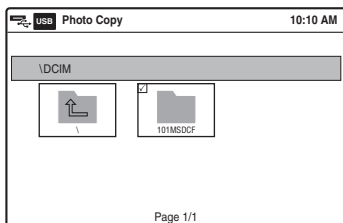

A check mark appears in the check box for the selected album. To clear the mark, press SET again.

Repeat the step to select all the albums you want to copy.

## 8 Press OPTIONS.

The display asks for confirmation.



To return to the previous display, select “Cancel.”

To cancel all selections, select “Clear All” and return to step 7.

## 9 Select “Start,” and press ENTER.

Copying starts.

### To stop copying

Press ENTER to cancel.

Note that it may take some time for the recorder to stop copying.

### To copy more albums on the same disc

Press SYSTEM MENU, and repeat from step 3 on page 94.

## Settings and Adjustments

# Using the Setup Displays

By using the setup displays, you can make various adjustments to items such as picture and sound, as well as select a language for the subtitles. The setup displays are used in the following way.

### Note

Playback settings stored on the disc take priority over the setup display settings, and not all of the functions described may work.

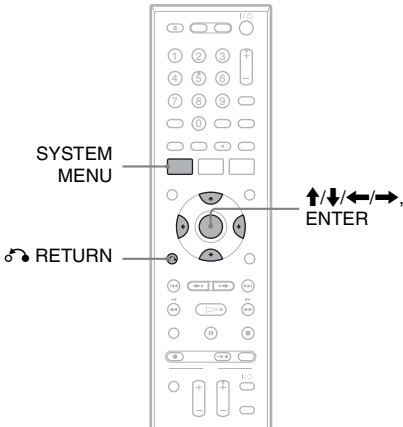

## 1 Press SYSTEM MENU while the recorder is in stop mode.

The System Menu appears.

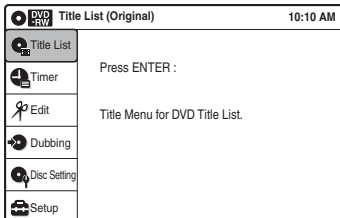

## 2 Select "Setup," and press ENTER.

The "Setup" display appears.

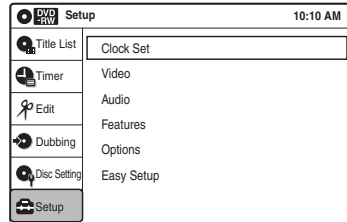

## 3 Select "Clock Set," "Video," "Audio," "Features," "Options," or "Easy Setup," and press ENTER.

The selected setup display appears. Example: "Video" setup

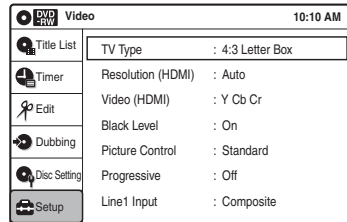

## 4 Select the item you want to set up, and press ENTER.

Available options for the item appear. Example: "TV Type"

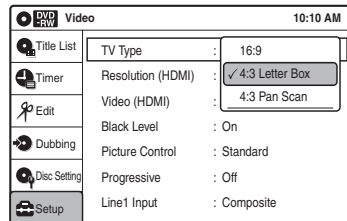



Some items display a dialog box that requires additional settings.

Example: When “Parental” in “Options” setup is selected.

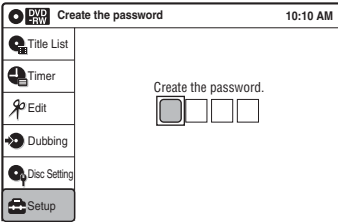

**5 Select an option, and press ENTER.**

The currently selected option is displayed next to the setup item.

Example: When “16:9” is set.

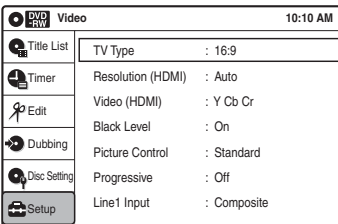

**To return to the previous display**

Press RETURN.

**To turn off the display**

Press SYSTEM MENU.

## Clock Setting (Clock Set)

The “Clock Set” setup allows you to make clock settings for the recorder.

**1 Press SYSTEM MENU while the recorder is in stop mode.**

**2 Select “Setup,” and press ENTER.**

**3 Select “Clock Set,” and press ENTER.**

The clock setting display appears.

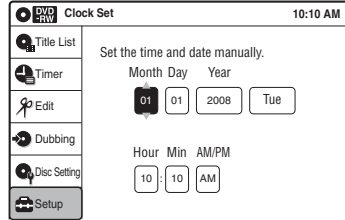

**4 Press to set the month, and press .**

Set the day, year, hour, minutes, and AM/PM in sequence. Press to select the item to be set, then press to set the item. The day of the week is set automatically.

**5 Press ENTER to start the clock.**

# Video Settings (Video)

The “Video” setup allows you to adjust items related to the image, such as size and color. Choose the settings according to the type of TV, tuner, or decoder connected to the recorder.

**1** Press **SYSTEM MENU** while the recorder is in stop mode.

**2** Select “Setup,” and press **ENTER**.

**3** Select “Video,” and press **ENTER**.

The “Video” setup appears with the following options. The default settings are underlined.

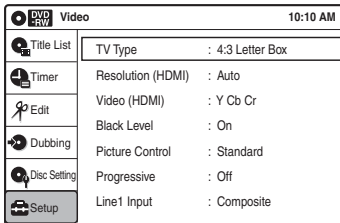

## TV Type

Selects the aspect ratio of the connected TV (4:3 standard or wide).

16:9	Select this when connecting to a wide-screen TV or TV with a wide mode function.
<u>4:3 Letter Box</u>	Select this when connecting to a 4:3 screen TV. Displays a wide picture with bands on the upper and lower portions of the screen.
4:3 Pan Scan	Select this when connecting to a 4:3 screen TV. Automatically displays a wide picture on the entire screen and cuts off the portions that do not fit.

16:9



4:3 Letter Box



4:3 Pan Scan

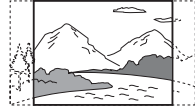

## Note

Depending on the disc, “4:3 Letter Box” may be selected automatically instead of “4:3 Pan Scan” or vice versa.

## Resolution (HDMI)

Selects the type of video signals output from the HDMI OUT jack. When you select “Auto” (default), the recorder outputs video signals of the highest resolution acceptable for your TV. If the picture is not clear, unnatural or not to your satisfaction, try another option that suits the disc and your TV/projector, etc. For details, refer also to the instruction manual supplied with the TV/projector, etc.

The setting is effective only when you connect a HDMI equipped TV to the HDMI OUT jack.

<u>Auto</u>	Normally, select this.
1920×1080p	Sends 1920×1080p video signals.
1920×1080i	Sends 1920×1080i video signals.
1280×720p	Sends 1280×720p video signals.
720×480p	Sends 720×480p video signals.

## Video (HDMI)

Selects the type of output from the HDMI OUT jack.

The setting is effective only when you connect a HDMI equipped TV to the HDMI OUT jack.

<u>Y Cb Cr</u>	Normally, select this when connecting to an HDMI device.
RGB	Outputs RGB signals. Select this if the playback picture becomes distorted when you select “Y Cb Cr.”

## Black Level

Selects the black level (setup level) for the video signals output from the LINE OUT jacks (page 15).

This setting is not effective when the recorder outputs progressive signals.

<u>On</u>	Raises the standard black level. Select this when the picture appears too dark.
Off	Sets the black level of the output signal to the standard level.

## Picture Control

Selects the picture control for the video signals output from the LINE OUT jacks (page 15).

You can adjust the video signal of DVD or VIDEO CD (with PBC function off) from the recorder to obtain the picture quality you want. Select the setting that best suits the program you are watching.

Dynamic 1	Produces a bold dynamic picture by increasing the picture contrast and the color.
Dynamic 2	Produces a more dynamic picture than “Dynamic 1” by further increasing the picture contrast and the color.
<u>Standard</u>	Displays a standard picture (function turned off).
Cinema 1	White colors become brighter and black colors become richer, and the color contrast is increased.
Cinema 2	Enhances details in dark areas by increasing the black level.
Personal	Adjusts “Contrast,” “Brightness,” “Color,” and “Hue” using $\uparrow/\downarrow$ / $\leftarrow/\rightarrow$ and ENTER.

### Hint

When you watch a movie, “Cinema 1” or “Cinema 2” is recommended.

## Progressive

If your TV accepts progressive (480p) format signals, you will enjoy accurate color reproduction and high quality image.

Connect your TV to the COMPONENT VIDEO OUT jacks (page 17).

<u>On</u>	Sets the recorder to output progressive signals.
Off	Outputs video signals in interlace format.

## Notes

- If you select progressive signals when you connect the recorder to a TV that cannot accept the signal in progressive format, the image quality will deteriorate. In this case, set “Progressive” to “Off.”
- When you connect your TV using an HDMI cable, the “Progressive” setting is set to “On.”

## Line1 Input

Selects the type of video input signal for the LINE 1 IN jacks. The picture does not appear if this setting does not match the connected jack.

S-Video	Select this when connecting to the S VIDEO jack (page 13).
<u>Composite</u>	Select this when connecting to the VIDEO jack.

# Audio Settings (Audio)

The “Audio” setup allows you to adjust the sound according to the playback and connection conditions.

**1** Press **SYSTEM MENU** while the recorder is in stop mode.

**2** Select “Setup,” and press **ENTER**.

**3** Select “Audio,” and press **ENTER**.

The “Audio” setup appears with the following options. The default settings are underlined.

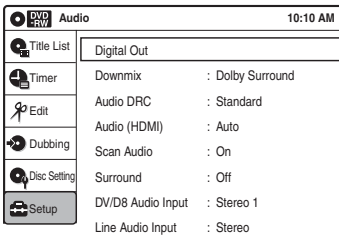

## Digital Out

The following setup items switch the method of outputting audio signals when you connect a component such as an amplifier (receiver) to the DIGITAL AUDIO OUT (COAXIAL) jack.

For connection details, see “Connecting to Your AV Amplifier (Receiver)” on page 18.

Press **ENTER**, and select “Dolby Digital” or “DTS.”

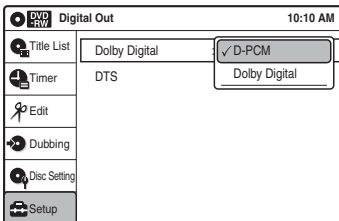

If you connect a component that does not accept the selected audio signal, a loud noise (or no sound) will come out from the speakers, and may affect your ears or cause speaker damage.

## ◆ Dolby Digital (DVDs only)

Selects the type of Dolby Digital signal.

<u>D-PCM</u>	Select this when the recorder is connected to an audio component lacking a built-in Dolby Digital decoder. You can select whether the signals conform to Dolby Surround or not by making adjustments to the “Downmix” item in “Audio” setup (page 101).
Dolby Digital	Select this when the recorder is connected to an audio component with a built-in Dolby Digital decoder.

### Note

If the HDMI OUT jack is connected to a TV not compatible with Dolby Digital signals, D-PCM signals will be automatically output, even if “Dolby Digital” is selected.

## ◆ DTS (DVD VIDEOS only)

Selects whether or not to output DTS signals.

On	Select this when the recorder is connected to an audio component with a built-in DTS decoder.
<u>Off</u>	Select this when the recorder is connected to an audio component without a built-in DTS decoder.

### Note

If you connect equipment not compatible with DTS signals, no signal will be output, regardless of the “DTS” setting.

### Downmix (DVDs only)

Switches the method for mixing down to two channels when you play a DVD which has rear sound elements (channels) or is recorded in Dolby Digital format. For details on the rear signal components, see “**A** Connecting to audio L/R jacks” on page 19. This function affects the output of the following jacks:

- LINE OUT (AUDIO L/R) jacks
- AUDIO OUT L/R jacks
- DIGITAL AUDIO OUT (COAXIAL)/HDMI OUT jack when “Dolby Digital” is set to “D-PCM” (page 100).

<u>Dolby Surround</u>	Normally select this position. Multi-channel audio signals are output to two channels for enjoying surround sounds.
Normal	Multi-channel audio signals are downmixed to two channels for use with your stereo.

To enjoy the surround effect of Dolby Digital, turn off the surround settings of this recorder (page 101).

### Audio DRC (Dynamic Range Control) (DVDs only)

Makes the sound clear when the volume is turned down when playing a DVD that conforms to “Audio DRC.” This affects the output from the following jacks:

- LINE OUT (AUDIO L/R) jacks
- AUDIO OUT L/R jacks
- DIGITAL AUDIO OUT (COAXIAL)/HDMI OUT jack only when “Dolby Digital” is set to “D-PCM” (page 100).

<u>Standard</u>	Normally select this position.
TV Mode	Makes low sounds clear even if you turn the volume down.
Wide Range	Gives you the feeling of being at a live performance.

### Audio (HDMI) (DVD VIDEOS only)

Selects the output method from the HDMI OUT jack.

<u>Auto</u>	Normally, select this. Outputs audio signals according to the “Dolby Digital” or “DTS” settings (page 100).
PCM	Converts Dolby Digital to PCM.

#### Note

If you select “Auto” when connecting the recorder to a TV not compatible with Dolby Digital or DTS, no sound may be heard. In this case, select “PCM.”

### Scan Audio (DVDs only)

<u>On</u>	Outputs audio signals during FF1 fast-forward of a DVD disc with Dolby Digital soundtracks.
Off	No sound is output during FF1 fast-forward.

#### Note

Sound will be interrupted during Scan Audio.

### Surround

Turns on the surround function to create virtual rear speakers from a stereo TV or two separate front speakers (page 19).

<u>Off</u>	No surround effect
Surround1	Creates one set of virtual surround speakers
Surround2	Creates two sets of virtual surround speakers
Surround3	Creates three sets of virtual surround speakers

#### Notes

- When the playback signal does not contain a signal for the surround speakers, the surround effects will be difficult to hear.
- When you select one of the surround modes, turn off the surround settings of the connected TV or amplifier (receiver).

## DV/D8 Audio Input

<u>Stereo 1</u>	Records original sound only. Normally select this when dubbing a DV format tape.
Stereo 2	Records additional audio only.
Mix	Records both original and additional sounds.

### Note

Select “Stereo 2” or “Mix” if you have added a second audio channel when recording with your DV camcorder.

## Line Audio Input

When recording from equipment connected to the LINE 1 IN or LINE 2 IN jacks to a DVD disc in this recorder, select line input audio.

<u>Stereo</u>	Records stereo sound only.
Main/Sub	Records the two different soundtracks on DVD-RWs (VR mode)/DVD-Rs (VR mode). You can select either soundtrack when playing back the disc.

### Hint

When recording on a disc other than DVD-RWs (VR mode)/DVD-Rs (VR mode), select either sound track with the connected equipment before recording.

# Recording, VCR, Set Top Box, Control for HDMI Settings (Features)

The “Features” setup allows you to make various settings for recording, playback, set top box control, and HDMI control functions.

- 1 Press **SYSTEM MENU** while the recorder is in stop mode.
- 2 Select **“Setup,”** and press **ENTER**.
- 3 Select **“Features,”** and press **ENTER**.

The “Features” setup appears with the following options. The default settings are underlined.

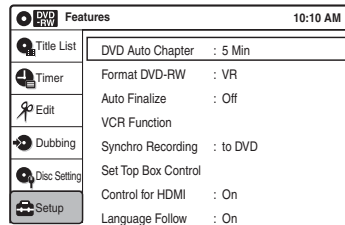

<b>DVD-RW Features</b>	10:10 AM
Title List	DVD Auto Chapter : 5 Min
Timer	Format DVD-RW : VR
	Auto Finalize : Off
	VCR Function
Dubbing	Synchro Recording : to DVD
Disc Setting	Set Top Box Control
Setup	Control for HDMI : On
	Language Follow : On

## DVD Auto Chapter

Automatically divides a recording (a title) into chapters by inserting chapter markings at specified intervals. The markings are inserted while the recording is being made.

Off	No chapter mark is inserted.
<u>5 Min</u>	Inserts chapter marks at approximately 5 minute intervals.
15 Min	Inserts chapter marks at approximately 15 minute intervals.

### Note

Actual intervals may differ depending on the size of the recording. The selected setting should be regarded as an approximate chapter interval.

## Format DVD-RW (DVD-RWs only)

Selects the recording format for an unused DVD-RW, when first inserted.

<u>VR</u>	Automatically formats the disc in VR mode.
Video	Automatically formats the disc in Video mode.

## Auto Finalize

On	Automatically finalizes a DVD-R (Video mode)/DVD-RW (Video mode)/DVD+R after recording, allowing immediate playback on other DVD equipment (page 67).
<u>Off</u>	Turns off the function.

## VCR Function

Press ENTER and select “Tape Length,” “Auto Play,” or “Auto Repeat.”

### ◆ Tape Length

<u>T120</u>	For T-120 or shorter length tapes.
T160	For T-160 length tapes.
T180	For T-180 or longer length tapes.

### ◆ Auto Play

<u>On</u>	Starts playback automatically, when you insert a tape with its safety tab removed.
Off	Turns off the function. You need to press $\triangleright$ PLAY to start playback, even if you insert a tape with its safety tab removed.

### ◆ Auto Repeat

On	Plays back a tape repeatedly. The VCR rewinds the tape to the beginning and restarts playback automatically.
<u>Off</u>	Turns off the function.

## Synchro Recording

<u>to DVD</u>	Sets the recorder to record programs from connected equipment that has a timer function (such as a satellite tuner) to a DVD disc.
to VIDEO	Sets the recorder to record programs from connected equipment that has a timer function (such as a satellite tuner) to a VHS tape.

## Set Top Box Control

You can control your cable box/satellite receiver using the supplied set top box controller. See “Step 7: Easy Setup” for details. Press ENTER, and select “On” or “Off.”

On	Turns on the cable box/satellite receiver control function. See “Using the cable box/satellite receiver control function” (page 12).
<u>Off</u>	Turns off the cable box/satellite receiver control function. Select this if you do not want to use the supplied set top box controller.

When “Set Top Box Control” is set to “On,” you can make the following settings. Note that when you change “Set Top Box Control” to “On” or “Off,” all timer recording settings will be canceled.

### ◆ Brand Code

See “Cable Box/Satellite Receiver Brand Code” (page 121) for the brand code for your cable box or satellite receiver, and enter the code using the number buttons and ENTER.

### ◆ Connections

Selects the connection you used for your cable box or satellite receiver. Select the connection from “Line1” or “Line2.”

### ◆ Ch. Digit lock

Allows you to select whether to fix the digits for your cable box or satellite receiver.

<u>Off</u>	Select this when your cable box or satellite receiver only accepts a three or more digit channel number. Normally select this.
Lock to 2 digits	Select this only when your cable box or satellite receiver only accepts a two digit channel number.

### ◆ Mode for SET button

Select “Mode 1” or “Mode 2” if your cable box or satellite receiver requires pressing an ENTER button or a SET button etc., after entering the channel number. If “Mode 1” does not work, try “Mode 2.” If your cable box or satellite receiver does not respond to either setting, contact the manufacturer of the cable box or satellite receiver.

<u>Off</u>	No code is sent when SET is pressed. Normally select this.
Mode 1	Sends the channel number you entered.
Mode 2	Sends the channel number you entered.

### Control for HDMI

<u>On</u>	Allows you to use the Control for HDMI function (page 16).
Off	Turns off the function.

### Language Follow

<u>On</u>	Switches the language of this recorder to the same as the current TV’s OSD language. You cannot select this when “Control for HDMI” is set to “Off.”
Off	Turns off the function.

### Notes

- Turn off any display before turning on this function.
- The OSD language for the recorder keeps if the TV’s language cannot be supported.

## Language, Parental Control Settings/Factory Settings (Options)

The “Options” setup allows you to set up other operational settings.

- 1 Press SYSTEM MENU while the recorder is in stop mode.**
- 2 Select “Setup,” and press ENTER.**
- 3 Select “Options,” and press ENTER.**

The “Options” setup appears with the following options. The default settings are underlined.

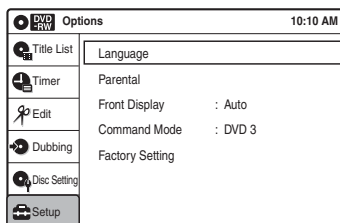

### Language

#### ◆ OSD (On-Screen Display)

Switches the display language on the screen.

#### ◆ Disc Menu (DVD VIDEOS only)

Switches the language for the DVD menu.

#### ◆ Audio (DVD VIDEOS only)

Switches the language of the soundtrack.

When you select “Original,” the language given priority in the disc is selected.

#### ◆ Subtitle (DVD VIDEOS only)

Switches the language of the subtitles recorded on the disc.

When you select “Auto,” the subtitle language changes according to the language you selected for the soundtrack. See page 120 for an explanation of the language abbreviations.

### Note

If you select a language in “Disc Menu,” “Subtitle,” or “Audio” that is not recorded on the DVD VIDEO, one of the recorded languages will be automatically selected.



## Parental (DVD VIDEOS only)

Playback of some DVD VIDEOS can be limited according to a predetermined level, such as the age of the users. Scenes may be blocked or replaced with different scenes.

1 After step 3 above, select “Parental,” and press ENTER.

- If you have not entered a password, the display for registering a new password appears.  
Enter a 4-digit password using the number buttons.

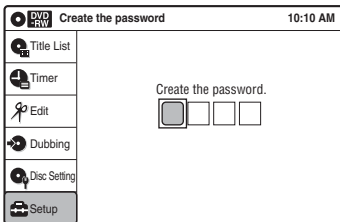

The display for confirming the password appears.

Re-enter the password.

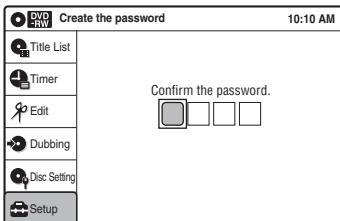

- When you have already registered a password, the display for entering the password appears.  
Enter a 4-digit password using the number buttons.

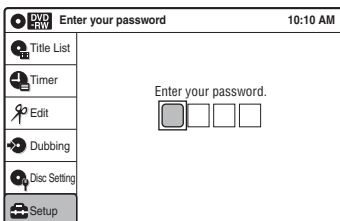

2 Select “Rating Level,” and press ENTER. The selection items for “Rating Level” are displayed.

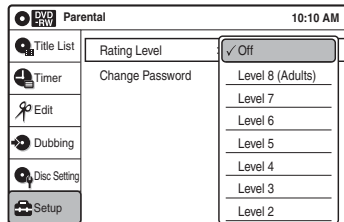

The lower the value, the stricter the limitation.

3 Select the level, and press ENTER. The Parental setting is complete.

- To cancel the Parental setting for the disc, set “Rating Level” to “Off” in step 3.
- To change the password, select “Change Password” in step 2, and press ENTER. When the display for registering a password appears, enter a new four-digit password using the number buttons.

### Hint

If you enter a wrong number, press ← or CLEAR and re-enter.

### Notes

- If you forget your password, select “Factory Setting” of “Options” in the “Setup” display.
- Playback of discs without the Parental Control function cannot be limited on this recorder.
- Depending on the disc, you may be asked to change the Parental Control level while playing the disc. In this case, enter your password, then change the level.

## Front Display

Adjusts the lighting of the front panel display.

<u>Auto</u>	Adjusts to low lighting when power is off.
Bright	Maintains bright lighting when power is off.
Dimmer	Maintains low lighting regardless of whether power is on or off.
Off	Turns off the lighting when power is off. Maintains the lighting when power is on.

## Command Mode

Changes the command mode of this recorder if other DVD equipment is assigned the same command mode. Be sure to match the command mode of the supplied remote to the setting made here. For details, see “If you have a Sony DVD player or more than one Sony DVD recorder” on page 22.

DVD 1	Select this if the default command mode conflicts with other DVD equipment.
DVD 2	Select this if the default command mode conflicts with other DVD equipment.
<u>DVD 3</u>	The default command mode of the recorder.

## Factory Setting

Allows you to return the setup settings to their default settings. Note that all of your previous settings will be lost.

- 1 After step 3 on page 104, select “Factory Setting,” and press ENTER.
- 2 Select “Start,” and press ENTER.  
The setup settings return to their default settings.
- 3 Press ENTER when “Finish” appears.  
The power automatically turns off and then on again, and the recorder is reset to the factory settings.  
When the “Easy Setup” display appears, follow the instructions for Easy Setup (page 23) from step 4.

## Easy Setup (Resetting the Recorder)

Select this to run the Easy Setup program.

- 1 Press **SYSTEM MENU** while the recorder is in stop mode.
- 2 Select “Setup,” and press **ENTER**.
- 3 Select “Easy Setup,” and press **ENTER**.

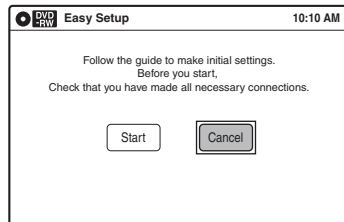

- 4 Select “Start,” and press **ENTER**.
- 5 Follow the instructions for Easy Setup (page 23) from step 5.

# Troubleshooting

If you experience any of the following difficulties while using the recorder, use this troubleshooting guide to help remedy the problem before requesting repairs. Should any problem persist, consult your nearest Sony dealer.

## Power

### The power does not turn on.

- ➔ Check that the AC power cord is connected securely.

### The recorder turns on automatically.

- ➔ HDMI input is selected using TV Interface. Some TV has this function for Control for HDMI. To turn off the function, set "Control for HDMI" to "Off" in the "Features" setup (page 104).

## Picture

### There is no picture.

- ➔ Re-connect all connecting cords securely.
- ➔ The connecting cords are damaged.
- ➔ Check the connection to your TV (page 12).
- ➔ Switch the input selector on your TV (such as to "VIDEO") so that the signal from the recorder appears on the TV screen.

### Picture noise appears.

- ➔ Check the connection to your TV (page 12) and switch the input selector on your TV so that the signal from the recorder appears on the TV screen.
- ➔ If the picture output signal from your recorder passes through your VCR to get to your TV, or if you are connected to a combination TV/VIDEO player, the copy-protection signal applied to some DVD programs could affect picture quality. If you still experience this problem even when you connect your recorder directly to your TV, try connecting your recorder to your TV's S VIDEO input.
- ➔ You have set the recorder to progressive format even though your TV cannot accept the progressive signal. In this case, set "Progressive" to "Off" in the "Video" setup (page 99).

- ➔ Even if your TV is compatible with progressive format (480p) signals, the image may be affected when you set the recorder to progressive format. In this case, set "Progressive" to "Off" in the "Video" setup (page 99).

### There is no picture or the picture noise appears when connected to the DV IN jack.

- ➔ Try the following: ① Turn the recorder off and on again. ② Turn the connected equipment off and on again. ③ Disconnect and then connect the i.LINK cable again.

### There is no picture or the picture noise appears when connected to the HDMI OUT jack.

- ➔ Try the following: ① Turn the recorder off and on again. ② Turn the connected equipment off and on again. ③ Disconnect and then connect the HDMI cord again.
- ➔ If the HDMI OUT jack is used for video output, changing the "Resolution (HDMI)" setting in the "Video" setup may solve the problem (page 98). Connect the TV and the recorder using a video jack other than the HDMI OUT, and switch the TV's input to the connected video input so that you can see the on-screen displays. Change the "Resolution (HDMI)" setting in the "Video" setup, and switch the TV's input back to HDMI. If the picture still does not appear, repeat the steps and try other options.
- ➔ The recorder is connected to an input device that is not HDCP compliant (page 16).

### The channel on the cable box/satellite receiver has been changed.

- ➔ The set top box controller is connected and "Set Top Box Control" is set to "On." Check the "Set Top Box Control" settings in the "Features" setup (page 103).

### The picture from equipment connected to the recorder's input jack does not appear on the screen.

- ➔ If the equipment is connected to the LINE 1 IN jack, select "LINE1" in the front panel display by pressing INPUT. If the equipment is connected to the LINE 2 IN jacks, select "LINE2" in the front panel display by pressing INPUT.
- ➔ If the equipment is connected to the LINE 1 IN S VIDEO jack, set "Line1 Input" to "S-Video" in the "Video" setup (page 99).

---

**The playback picture or TV program from the equipment connected through the recorder is distorted.**

- ➔ If the playback picture output from a DVD player, VCR, or tuner goes through your recorder before reaching your TV, the copy-protection signal applied to some programs could affect picture quality. Disconnect the playback equipment in question and connect it directly to your TV.

---

**The picture does not fill the screen.**

- ➔ Set “TV Type” in the “Video” setup to fit the aspect ratio of your TV (page 98).

---

**The picture does not fill the screen, even though the aspect ratio is set in “TV Type” in “Video” setup.**

- ➔ The aspect ratio of the disc is fixed on your DVD.

---

**Sound****There is no sound.**

- ➔ Re-connect all connections securely.
- ➔ The connecting cord is damaged.
- ➔ The input source setting on the amplifier or the connection to the amplifier is incorrect.
- ➔ The recorder is in reverse play, fast-forward, slow motion, or pause mode.
- ➔ If the audio signal does not come through the DIGITAL AUDIO OUT (COAXIAL) jack, check the “Audio” setup settings (page 100).

---

**No sound is output from the HDMI OUT jack.**

- ➔ Try the following: ①Turn the recorder off and on again. ②Turn the connected equipment off and on again. ③Disconnect and then connect the HDMI cord again.
- ➔ The HDMI OUT jack is connected to a DVI device (DVI jacks do not accept audio signals).
- ➔ The equipment connected to the HDMI OUT jack does not conform to the audio signal format.

---

**Sound is noisy.**

- ➔ When playing a CD with DTS soundtracks, noise will come from the LINE OUT (AUDIO L/R) or AUDIO OUT L/R jacks (page 36).

---

**The sound volume is low.**

- ➔ The sound volume is low on some DVDs. The sound volume may improve if you set “Audio DRC” in the “Audio” setup to “Wide Range” (page 101).

---

**An alternate audio track cannot be recorded or played.**

- ➔ If you have connected an AV amplifier to the DIGITAL AUDIO OUT (COAXIAL) jack and want to change the audio track for a DVD-RW (VR mode)/DVD-R (VR mode) during playback, set “Dolby Digital” in “Audio” setup to “D-PCM” (page 100).
- ➔ When recording to a disc other than DVD-RWs (VR mode)/DVD-Rs (VR mode), set “Line Audio Input” in “Audio” setup to “Stereo.”

---

**DVD Playback****The disc does not play.**

- ➔ The disc is upside down. Insert the disc with the labeled side facing up.
- ➔ The disc is not correctly inserted.
- ➔ Moisture has condensed inside the recorder. Remove the disc and leave the recorder turned on for about half an hour until the moisture evaporates.
- ➔ If the disc was recorded on another recorder, the recorder cannot play the disc if it was not finalized (page 66).

---

**The disc does not start playback from the beginning.**

- ➔ Resume play was activated (page 37).
- ➔ You have inserted a disc whose Title menu or DVD menu automatically appears on the TV screen when it is first inserted. Use the menu to start playback.

---

**The recorder starts playing the disc automatically.**

- ➔ The DVD VIDEO features an auto playback function.

---

**Playback stops automatically.**

- ➔ If the disc has an auto pause signal, the recorder stops playback at the auto pause signal.

---

**Some functions such as Stop, Search, or Slow-motion Play cannot be performed.**

- ➔ Depending on the disc, you may not be able to do some of the operations above. See the instruction manual supplied with the disc.
- ➔ While the recorder is reading disc information, playback operations will not work.

---

**The language for the soundtrack cannot be changed.**

- ➔ Multilingual tracks are not recorded on the disc being played.
- ➔ The DVD VIDEO prohibits the changing of the language for the soundtrack.
- ➔ Try changing the language using the DVD VIDEO's menu.

---

**The subtitle language cannot be changed or turned off.**

- ➔ Multilingual subtitles are not recorded on the DVD VIDEO.
- ➔ The DVD VIDEO prohibits changing of the subtitles.
- ➔ Try changing the subtitle using the DVD VIDEO's menu.
- ➔ The subtitles cannot be changed for the titles recorded on this recorder.

---

**The angles cannot be changed.**

- ➔ Multi-angles are not recorded on the DVD VIDEO being played.
- ➔ The DVD VIDEO prohibits changing angles.
- ➔ Try changing the angle using the DVD VIDEO's menu.
- ➔ The angles cannot be changed for the titles recorded on this recorder.

---

**The MP3 audio track cannot be played.**

- ➔ The DATA CD is not recorded in the MP3 format that conforms to ISO9660 Level 1/ Level 2.
- ➔ The MP3 audio track does not have the extension “.MP3.”
- ➔ The data is not formatted in MP3 even though it has the extension “.MP3.”
- ➔ The data is not MPEG1 Audio Layer 3 data.
- ➔ The recorder cannot play audio tracks in MP3PRO format.
- ➔ When playing a disc containing JPEG image files, “Photo” is selected (page 41).

---

**The JPEG image file cannot be played.**

- ➔ The DATA CD is not recorded in a JPEG format that conforms to ISO9660 Level 1/Level 2.
- ➔ The JPEG image file does not have the extension “.JPG” or “.JPEG.”
- ➔ The data is not formatted in JPEG even though it has the extension “.JPG” or “.JPEG.”
- ➔ The length or width of the image is more than 4,720 dots.
- ➔ When playing a disc containing MP3 audio tracks, “Music” is selected (page 42).

---

**The title of the MP3 audio album/ track or JPEG image folder/file is not correctly displayed.**

- ➔ The recorder can only display numbers and alphabet. Other characters are displayed as asterisks.

---

**DVD Recording/Timer recording/ Editing**

---

**The channel cannot be changed from the channel you are recording.**

- ➔ Set the TV's input source to “TV.”

---

**Recording does not start immediately after****● REC is pressed.**

- ➔ Operate the recorder only after “LOAD,” “FORMAT,” or “INF WRITE” disappears from the front panel display.

---

**Nothing was recorded even though the timer setting is set correctly.**

- ➔ There was a power failure during recording.
- ➔ Disconnect the AC power cord from the AC outlet, and connect it again.
- ➔ The program contains copy protection signals that restrict copying.
- ➔ The program that starts first has priority and the second program starts recording only after the first program has finished. If the programs start at the same time, the program listed first in the menu has priority (page 52).
- ➔ There is no DVD inserted in the recorder.
- ➔ There is not enough disc space for the recording.
- ➔ The connected cable box/satellite receiver was turned off.
- ➔ The set top box controller was incorrectly connected (page 12).
- ➔ The settings in “Set Top Box Control” in the “Features” setup have been changed (page 103).

---

**Recording does not stop immediately after****■ STOP is pressed.**

- ➔ It will take a few seconds for the recorder to input disc data before recording can stop.

---

**Timer recording is not complete or did not start from the beginning.**

- ➔ There was a power failure during recording.
- ➔ The recorder's internal clock stopped due to a power failure that lasted for more than 30 minutes. Reset the clock (page 97).
- ➔ The channel or input changed from the one you are recording.
- ➔ The program that starts first has priority and the second program starts recording only after the first program has finished. If the programs start at the same time, the program listed first in the menu has priority (page 52).
- ➔ There is not enough disc space for the recording.

---

**The ☺ indicator flashes after timer recording is set.**

- ➔ Insert a recordable disc (page 30).
- ➔ The disc has 99 or more titles, which prevents further recording.
- ➔ The disc is protected (page 64).
- ➔ The disc is finalized (page 66).

---

**The SYNC-REC indicator flashes after Synchro-Recording is set.**

- ➔ Insert a recordable disc (page 30).
- ➔ Insert a disc with enough space for the recording.
- ➔ The disc has 99 or more titles, which prevents further recording.
- ➔ The disc is protected (page 64).
- ➔ The disc is finalized (page 66).

---

**Contents previously recorded were erased.**

- ➔ Data that has been recorded on a DVD with a PC will be erased from the disc when the disc is inserted.

---

**VCR Playback****The playback picture does not appear on the TV screen.**

- ➔ Make sure the TV is set to the channel for the VCR. If a monitor is used, set it to video input.

---

**The picture is not clear.**

- ➔ Adjust the tracking by the TRACKING +/- button.
- ➔ The video heads are dirty (see page 113). Clean the video heads using a Sony video head cleaning cassette. If a Sony cleaning cassette is not available in your area, have the heads cleaned at your nearest Sony dealer (a standard service fee will be charged). Do not use a commercially available liquid type cleaning cassette, as it may damage the video heads.
- ➔ The video heads may have to be replaced. Consult your local Sony dealer for more information.
- ➔ The tape is defective.

---

**The picture rolls vertically during picture search.**

- ➔ Adjust the vertical hold control on the TV or monitor.

---

**The picture has no sound.**

- ➔ The tape is defective.
- ➔ Check the audio cord connection.

---

**A tape cannot be inserted.**

- ➔ Check that a tape is not already in the tape compartment.

---

**VCR Recording****The channel cannot be changed from the one you are recording.**

- ➔ Set the TV's input source to "TV."

---

**No TV program appears on the TV screen.**

- ➔ Make sure the TV is set to the channel for the VCR. If a monitor is used, set it to video input.

---

**The tape starts playing as soon as it is inserted.**

- ➔ The safety tab has been removed. To record on this tape, cover the tab hole.

---

**The tape is ejected when ● REC is pressed.**

- ➔ Check that the safety tab has not been removed.

---

**Nothing happens when ● REC is pressed.**

- ➔ Make sure the tape is not at its end.

---

## VCR Timer recording

### The timer does not operate.

- ➔ Check that the clock is correctly set.
- ➔ Make sure a tape has been inserted.
- ➔ Check that the safety tab has not been removed.
- ➔ Make sure the tape is not at its end.
- ➔ Make sure a program has been set for timer recording.
- ➔ Make sure the timer settings are set for a future time.
- ➔ Check that the cable box is turned on.
- ➔ “- :- -” appears in the front panel display if the recorder is disconnected from the wall outlet for more than 30 minutes. Reset the clock and timer.
- ➔ Turn the power off and unplug the AC power cord.
- ➔ The program that starts first has priority and the second program starts recording only after the first program has finished. If the programs start at the same time, the program listed first in the menu has priority (page 78).

---

### The ☹ indicator flashes after timer recording is set.

- ➔ Check that the safety tab has not been removed (page 74).

---

### The SYNC-REC indicator flashes after Synchro-Recording is set.

- ➔ Check that the safety tab has not been removed (page 74).

---

## Display

### Menus or displays do not appear on the screen.

- ➔ While the recorder is reading disc information, the System Menu, OPTIONS menu, or information display will not appear.

---

### Display language on the screen switches automatically.

- ➔ When “Language Follow” is set to “On” in the “Features” setup (page 104), the display language on the screen automatically switches, according to the language setting of the connected TV, if you change the language settings on your TV, etc.

---

### “- :- -” appears in the front panel display.

- ➔ Set the clock again (page 97).

---

### The ☹ indicator is flashing.

- ➔ The disc does not have any space for recording.
- ➔ Insert a recordable disc or a tape with its safety tab in place inside the recorder.

---

### The recording mode indication is incorrect.

- ➔ Since the recording mode for recorded titles is calculated after sampling the recorded data during playback, it may be displayed differently from the mode you selected when recording. However, the actual recording itself is correctly made in the selected mode.

---

## Remote control

### The remote does not function.

- ➔ Batteries are weak.
- ➔ The remote is too far from the recorder.
- ➔ The remote’s manufacturer code returned to the default setting when you replaced the batteries. Reset the code (page 21).
- ➔ Turn on the recorder.
- ➔ The remote is not pointed at the remote sensor on the recorder.
- ➔ Different command modes are set for the recorder and remote. Set the same command mode (page 22).

---

### Other Sony equipment responds to the remote.

- ➔ The same command mode is set for both the Sony DVD equipment. Set a different command mode for the recorder (page 22).

---

## Others

### The recorder does not operate properly.

- ➔ Restart the recorder. Press down I/⏻ on the recorder for more than ten seconds until “SONY DVD” appears in the front panel display.
- ➔ When static electricity, etc., causes the recorder to operate abnormally, turn off the recorder and wait until the clock appears in the front panel display. Then, unplug the recorder and after leaving it off for a while, plug it in again.

---

### The disc tray does not open after you press ▲ OPEN/CLOSE.

- ➔ It may take a few seconds for the disc tray to open after you have recorded or edited a disc. This is because the recorder is adding disc data to the disc.

---

**“Cannot record because of high temperature.” appears on the TV screen.**

- ➔ Check that the vent on the rear of the recorder is not blocked. Then, turn off the recorder, wait until the clock appears in the front panel display, and disconnect the AC power cord. Leave the recorder off for a while, then re-connect the power cord, and press **I/⏻** on the recorder.

---

**“CHILD LOCK” appears in the front panel display.**

- ➔ The recorder is locked. Cancel the Child Lock (page 37).

---

**Control by AV mouse is not possible.**

- ➔ Some satellite receivers may not support AV mouse.

---

**The Set Top Box Control function does not work.**

- ➔ Turn on the recorder.

---

**The Control for HDMI function does not work.**

- ➔ When “HDMI” does not appear in the front panel display, check the HDMI connection (page 16).
- ➔ Set “Control for HDMI” to “On” in the “Features” setup (page 104).
- ➔ Make sure that the connected component is compatible with the Control for HDMI function. Please refer to the operating instructions of the component for detailed explanation.
- ➔ If you change the HDMI connection, connect and disconnect the AC power cord, or have a power failure, set “Control for HDMI” to “Off” in the “Features” setup, then set it to “On” (page 104).

---

**The recorder does not detect a USB device connected to the recorder.**

- ➔ Make sure that the USB device is securely connected to the recorder (page 89).
- ➔ Check if the USB device or a cable is damaged.
- ➔ Check if the USB device is tuned on.

---

## Notes About This Recorder

### On adjusting volume

Do not turn up the volume while listening to a section with very low level inputs or no audio signals. If you do, the speakers may be damaged when a peak level section is played.

### On cleaning

Clean the cabinet, panel, and controls with a soft cloth slightly moistened with a mild detergent solution. Do not use any type of abrasive pad, scouring powder or solvent such as alcohol or benzene.

### On cleaning discs, disc/lens cleaners

**Do not use cleaning discs or disc/lens cleaners (including wet or spray types). These may cause the apparatus to malfunction.**

### On replacement of parts

In the event that this unit is repaired, repaired parts may be collected for reuse or recycling purposes.

### Notes about the discs

- To keep the disc clean, handle the disc by its edge. Do not touch the surface. Dust, fingerprints, or scratches on the disc may cause it to malfunction.



- Do not expose the disc to direct sunlight or heat sources such as hot air ducts, or leave it in a car parked in direct sunlight as the temperature may rise considerably inside the car.
- After playing, store the disc in its case.
- Clean the disc with a cleaning cloth. Wipe the disc from the center out.



- Do not use solvents such as benzene, thinner, commercially available disc/lens cleaners, or anti-static spray intended for vinyl LPs.
- Do not use the following discs.



- A disc that has a non-standard shape (e.g., card, heart).
- A disc with a label or sticker on it.
- A disc that has cellophane tape or sticker adhesive on it.

### Symptoms caused by contaminated video heads



When the video heads are dirty, the picture is distorted or the tape cannot be played. Clean the video heads using a Sony video head cleaning cassette. If a Sony cleaning cassette is not available in your area, have the heads cleaned at your nearest Sony dealer (a standard service fee will be charged). Do not use a commercially available liquid type cleaning cassette, as it may damage the video heads.

## Specifications

### System

#### [DVD recorder section]

##### Laser

Semiconductor laser

##### Audio recording format

Dolby Digital

##### Video recording format

MPEG Video

#### [VCR section]

##### Format

VHS NTSC standard

##### Video recording system

Rotary head helical scanning FM system

##### Video heads

Double azimuth four heads

##### Video signal

NTSC color, EIA standards

##### Tape speed

SP: 33.35 mm/s ( $1\frac{3}{8}$  inches/s)

EP: 11.12 mm/s ( $\frac{7}{16}$  inches/s)

LP: 16.67 mm/s ( $1\frac{1}{16}$  inches/s),  
playback only

##### Maximum recording/playback time

8 hrs. in EP mode (with T-160 tape)

##### Rewind time

Approx. 2 min (with T-120 tape)

#### [Timer section]

##### Clock

Quartz locked

##### Timer indication

12-hour cycle

##### Timer setting

12 programs in total (max.)

## Inputs and outputs

### LINE 1 IN and LINE 2 IN

VIDEO IN, phono jack (1 each)  
Input signal: 1 Vp-p, 75 ohms, unbalanced, sync negative  
AUDIO IN, phono jacks (2 each)  
Input level: 327 mVrms  
Input impedance: more than 47 kilohms  
S VIDEO, 4-pin, mini-DIN jack  
Y: 1.0 Vp-p, unbalanced, sync negative  
C: 0.286 Vp-p, load impedance 75 ohms  
DV IN, 4-pin jack, i.LINK S100

### LINE OUT

VIDEO OUT, phono jack (1)  
Output signal: 1 Vp-p, 75 ohms, unbalanced, sync negative  
AUDIO OUT, phono jacks (2)  
Standard output: 327 mVrms  
Load impedance: 47 kilohms  
Output impedance: less than 10 kilohms

### DIGITAL AUDIO OUT

COAXIAL, phono jack  
Output signal: 0.5 Vp-p, 75 ohms

### COMPONENT VIDEO OUT (Y, P<sub>B</sub>, P<sub>R</sub>)

Phono jack  
Y: 1.0 Vp-p/P<sub>B</sub>, P<sub>R</sub>: 0.7 Vp-p, 75 ohms

### SET TOP BOX CONTROL

Mini jack

### HDMI OUT

HDMI 19 pin-Standard Connector

### USB

USB jack Type A (For connecting camcorders or digital still cameras)

## General

### Power requirements

120 V AC, 60 Hz

### Power consumption

29 W

### Power back-up

Back-up duration: 30 min

### Operating temperature

5°C to 35°C (41°F to 95°F)

### Storage temperature

-20°C to 60°C (-4°F to 140°F)

### Operating humidity

25% to 80%

### Dimensions including projecting parts and controls (w/h/d)

Approx. 430 × 82 × 329 mm  
(Approx. 17 × 3 1/4 × 13 inches)

### Mass

Approx. 4.6 kg (Approx. 10.1 lbs)

### Supplied accessories

Remote commander (remote) (1)  
Size AA (R6) batteries (2)  
Audio/video cord (1)  
Set top box controller (1)

Design and specifications are subject to change without notice.

---

## About i.LINK

The DV IN jack on this recorder is an i.LINK-compliant DV IN jack. This section describes the i.LINK standard and its features.

### What is i.LINK?

i.LINK is a digital serial interface for handling digital video, digital audio and other data in two directions between equipment having the i.LINK jack, and for controlling other equipment.

i.LINK-compatible pieces of equipment can be connected by a single i.LINK cable. Possible applications are operations and data transactions with various digital AV equipment. When two or more i.LINK-compatible equipment are connected to this recorder in a daisy chain, operations and data transactions are possible with not only the equipment that this recorder is connected to but also with other devices via the directly connected equipment.

Note, however, that the method of operation sometimes varies according to the characteristics and specifications of the equipment to be connected, and that operations and data transactions are sometimes not possible on some connected equipment.

### Note

Normally, only one piece of equipment can be connected to this recorder by the i.LINK cable (DV connecting cable). When connecting this recorder to i.LINK-compatible equipment having two or more i.LINK jacks (DV jacks), see the instruction manual of the equipment to be connected.

---

## About the name “i.LINK”

i.LINK is a more familiar term for IEEE 1394 data transport bus proposed by SONY, and is a trademark approved by many corporations. IEEE 1394 is an international standard standardized by the Institute of Electrical and Electronics Engineers.

---

## i.LINK baud rate

i.LINK's maximum baud rate varies according to the equipment. Three maximum baud rates are defined:

- S100 (approx. 100 Mbps\*)
- S200 (approx. 200 Mbps)
- S400 (approx. 400 Mbps)

The baud rate is listed under “Specifications” in the instruction manual of each equipment. It is also indicated near the i.LINK jack on some equipment.

The maximum baud rate of equipment on which it is not indicated such as this unit is “S100.”

When units are connected to equipment having a different maximum baud rate, the baud rate sometimes differs from the indicated baud rate.

\* What is Mbps?

Mbps stands for megabits per second, or the amount of data that can be sent or received in one second. For example, a baud rate of 100 Mbps means that 100 megabits of data can be sent in one second.

---

## i.LINK functions on this recorder

For details on how to dub when this recorder is connected to other video equipment having DV jacks, see page 86.

The DV jack on this recorder can only input DVC-SD signals. It cannot output signals. The DV jack will not accept MICROMV signals from equipment such as a MICROMV digital video camera with an i.LINK jack.

For further precautions, see the notes on page 86. For details on precautions when connecting this recorder, also see the instruction manuals for the equipment to be connected.

---

## Required i.LINK cable

Use the Sony i.LINK 4-pin-to-4-pin cable (during DV/D8 dubbing).

i.LINK and  are trademarks.

# Guide to Parts and Controls

For more information, see the pages in parentheses.

## Front panel

Buttons on the recorder have the same function as the buttons on the remote if they have the same or similar names.

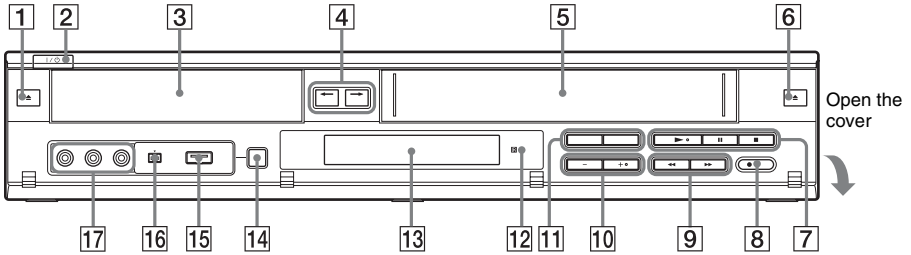

- 1** ▲ (open/close) button (34, 49)
- 2** I/⏻ (on/standby) switch (23)
- 3** Disc tray (34, 49)
- 4** ONE-TOUCH DUBBING  
(DVD) ← VIDEO button (83)  
DVD → (VIDEO) button (84)
- 5** Tape compartment (68, 75)
- 6** ▲ (eject) button (68)
- 7** ► (play) button (34, 68)
  - ⏸ (pause) button (35, 49, 70, 75)
  - (stop) button (34, 49, 68, 75)
- 8** ● REC (record) button (49, 75)
- 9** ◀◀/▶▶ (fast-reverse/fast-forward) buttons (36)
- 10** CHANNEL/TRACKING +/- buttons\*<sup>1</sup>\*<sup>2</sup> (49, 69, 75)
- 11** SELECT DVD/VIDEO buttons (34, 49, 68, 75)
- 12** 📡 (remote sensor) (20)
- 13** Front panel display (41, 72)
- 14** ONE-TOUCH DUBBING button (87, 90, 91, 93)
- 15** 📶 (USB) jack (89)
- 16** DV IN jack (86)
- 17** LINE 2 IN (VIDEO/AUDIO L (MONO)/R) jacks (27)

\*<sup>1</sup> The CHANNEL/TRACKING + button has a tactile dot. Use the tactile dot as a reference.

\*<sup>2</sup> The CHANNEL +/- buttons are used for channel selection when the set top box control is turned on (page 12).

# Remote

## For DVD functions

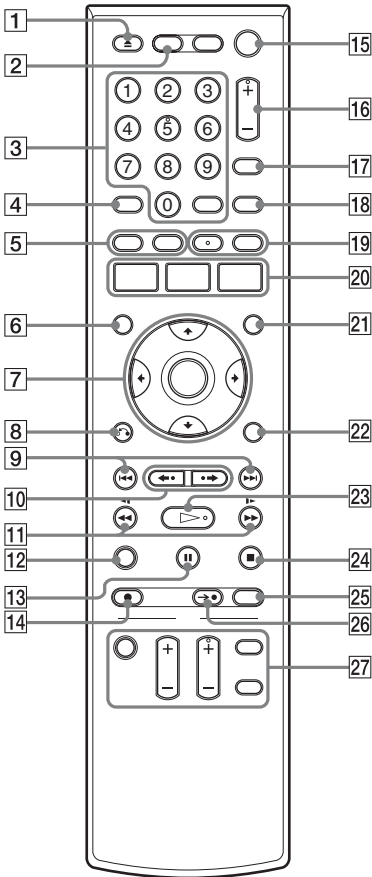

- 1 ▲ OPEN/CLOSE button (34, 49, 87)
- 2 DVD button (34, 49)
- 3 Number buttons\*<sup>1</sup> (21, 35)  
SET button (91, 93, 104)
- 4 ANGLE button (35)
- 5 TOP MENU button (34)  
MENU button (34)
- 6 DISPLAY button (40)
- 7 ↑/↓/←/→/ENTER button (23)
- 8 ↻ RETURN button (23)

- 9 ◀◀ PREV (previous)/▶▶ NEXT buttons (35)
- 10 ◀◀ REPLAY/▶▶ ADVANCE buttons (35)
- 11 ◀◀◀/◀/▶/▶▶ (search) buttons (35)
- 12 CLEAR button (105)
- 13 ■ PAUSE button (49)
- 14 ● REC (record) button (49)
- 15 I/⏻ (on/standby) switch (23)
- 16 CH (channel) +/- button\*<sup>1</sup>\*<sup>2</sup> (12, 49)
- 17 INPUT button (49, 56, 87)
- 18 TIME/TEXT button (41)
- 19 AUDIO button\*<sup>1</sup> (35)  
SUBTITLE button (35)
- 20 SYSTEM MENU button (10)  
TITLE LIST button (38, 58)  
TIMER button (51)
- 21 ORIGINAL/PLAYLIST button (38, 58)
- 22 OPTIONS button (39)
- 23 ▷ PLAY button\*<sup>1</sup> (34)
- 24 ■ STOP button (34, 49)
- 25 REC MODE button (49, 87)
- 26 SYNCHRO REC button (54)
- 27 TV buttons
  - I/⏻ (on/standby) switch (21)
  - INPUT button (21)
  - CH (channel) +/- button\*<sup>1</sup> (21)
  - VOL (volume) +/- button (21)
  - DIGITAL/ANALOG button (21)

\*<sup>1</sup> Number 5, AUDIO, CH +, and ▷ PLAY buttons have a tactile dot. Use the tactile dot as a reference.

\*<sup>2</sup> The CH +/- button are used for channel selection when the set top box control is turned on (page 12).

## For VCR functions

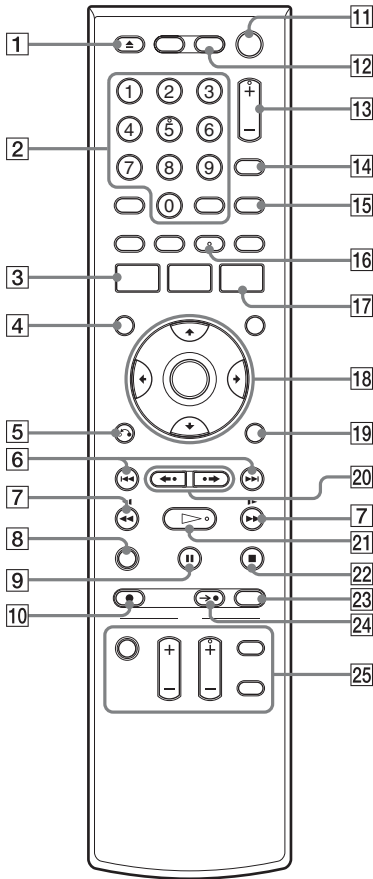

- 1** ▲ OPEN/CLOSE (eject) button (68)
- 2** Number buttons\*<sup>1</sup> (21)  
SET button (104)
- 3** SYSTEM MENU button (10)
- 4** DISPLAY button (72)
- 5** ↻ RETURN button (23)
- 6** ◀◀ PREV (previous)/▶▶ NEXT buttons (70)
- 7** ◀◀◀/▶▶▶ (search) buttons (70)
- 8** CLEAR button (68)
- 9** || PAUSE button (70, 75)
- 10** ● REC (record) button (75)
- 11** I/⏻ (on/standby) switch (23)
- 12** VIDEO button (68, 75)
- 13** CH (channel)/TRACKING +/- button\*<sup>1</sup>\*<sup>2</sup> (12, 69, 75)
- 14** INPUT button (75)
- 15** TIME/TEXT button (72)
- 16** AUDIO button\*<sup>1</sup> (73)
- 17** TIMER button (77)
- 18** ↑/↓/←/→/ENTER button (23)
- 19** OPTIONS button (71)
- 20** ◀◀ REPLAY/▶▶ ADVANCE buttons (70)
- 21** ▷ PLAY button\*<sup>1</sup> (68)
- 22** ■ STOP button (68, 75)
- 23** REC MODE button (75)
- 24** SYNCHRO REC button (80)
- 25** TV buttons
  - I/⏻ (on/standby) switch (21)
  - INPUT button (21)
  - CH (channel) +/- button\*<sup>1</sup> (21)
  - VOL (volume) +/- button (21)
  - DIGITAL/ANALOG button (21)

\*<sup>1</sup> Number 5, AUDIO, CH +, and ▷ PLAY buttons have a tactile dot. Use the tactile dot as a reference.

\*<sup>2</sup> The CH +/- button are used for channel selection when the set top box control is turned on (page 12).

## Front panel display

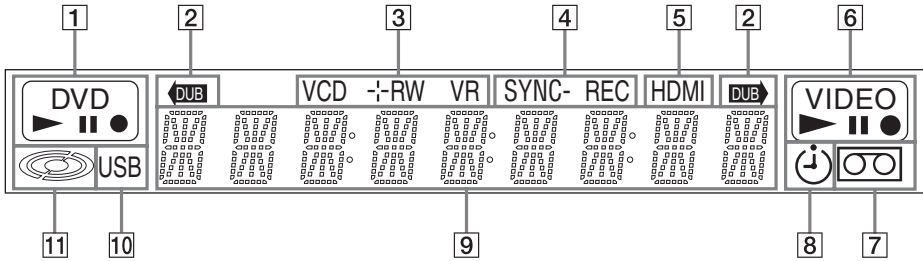

- 1** DVD playing/recording status
- 2** DUB (DVD ← VIDEO) indicator (83)  
DUB (DVD → VIDEO) indicator (84)
- 3** Disc type/recording format
- 4** SYNC-REC indicator (54, 80)
- 5** HDMI indicator (16)
- 6** VIDEO playing/recording status
- 7** Tape indicator
- 8** Timer indicator
- 9** Displays the following (41, 72):
  - Playing time/remaining time
  - Current title/chapter/track/index number
  - Recording time/recording mode
  - Clock
  - Channel
- 10** USB indicator (89)
- 11** Disc indicator

## Rear panel

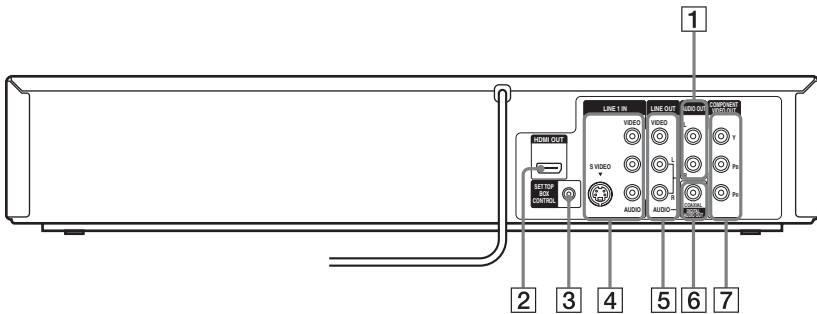

- 1** AUDIO OUT L/R jacks (18)
- 2** HDMI OUT jack (16)
- 3** SET TOP BOX CONTROL jack (13)
- 4** LINE 1 IN (S VIDEO/VIDEO/AUDIO L/R) jacks (13)
- 5** LINE OUT (VIDEO/AUDIO L/R) jacks (15, 17)
- 6** DIGITAL AUDIO OUT (COAXIAL) jack (18)
- 7** COMPONENT VIDEO OUT (Y, Pb, Pr) jacks (17)

---

## DVD Audio/Subtitle Language

When you play a DVD VIDEO, the language of the selected audio track or subtitle is abbreviated as follows. See page 104 to change the audio track or subtitle.

Abbreviation	Language
TUR	Turkish
VIE	Vietnamese
ZAF	Afrikaans

Abbreviation	Language
ARA	Arabic
BUL	Bulgarian
CHI	Chinese
CRO	Croatian
CZE	Czech
DAN	Danish
DEU	German
ENG	English
ESP	Spanish
FIN	Finnish
FRA	French
GRE	Greek
HUN	Hungarian
IDN	Indonesian
IND	Hindi
ISL	Icelandic
ITA	Italian
IWR	Hebrew
JPN	Japanese
KOR	Korean
MAL	Malay
NLD	Dutch
NOR	Norwegian
POL	Polish
POR	Portuguese
RUS	Russian
SVE	Swedish
THA	Thai



# Cable Box/Satellite Receiver Brand Code

When you want to use the set top box control function, find the brand code number of your cable box/satellite receiver from the list and enter it in step 7 of Easy Setup (page 23).

If more than one code number is listed, try entering them one at a time until you find the one that works with your cable box/satellite receiver.

Cable box brand	Code number
3M	0033
ABC	0003, 0007, 0011, 0017, 0008, 0014, 0001, 0013, 0206, 0047, 0237, 0033
Accuphase	0003, 0007, 0013, 0047, 0001, 0011, 0017, 0014, 0206
Acorn	1102, 0237
Action	0237
Active	0237, 1102
Aim	0015
Allegro	0315, 0153
Amark	0008, 0277, 0144, 0056
American	0060
Americast	0899
Antronix	0207, 0022
Anvision	0211, 0111
Apache	0770
Arbatron	0014, 0011, 0003, 0476
Archer	0153, 0022, 0207, 0039, 0797, 0237, 0260
ASE	1080
Auna	1269
BBT	0267
BCC	0276
Belcor	0056, 0022
Bell & Howell	0014
Bell Atlantic	0641
Bell South	0899
Bestlink	0303

Cable box brand	Code number
Betavue	0022
British Telecom	0003
BVS	0641
Cable Healthcare	0769, 0058
Cable Star	0056
Cabletenna	0022, 0039
Cableview	0022
Century	0153, 0618, 0008, 0315
Citation	0017
Citizen	0153, 0315, 0078, 0242
Clearmaster	0883
ClearMax	0883, 1247
Colour Voice	0031, 0025
Comband	0233, 0232
Comtec	0274
Comtronics	0060, 0040
Comtronics Eagle	0040, 0060
Contec	0019
Coolmax	0883
Curtis Mathes	0015, 0242
Dae Ryung Eagle	0008
Daeryung	0008, 0877, 0477, 0277, 1877
Diamond	0035
Digeo	1476
Digi	0637
Director	0476
Dumont	0637
Eagle Comtronics	0060, 0028
Eastern	0002, 0274, 0418
Electricord	0078
Emerson	0797, 0303, 0015, 0014
Everquest	0040, 0015
Focus	0400
Fosgate	0276
Fujitsu	0246
Funai	0248, 0019
FutureVision	0649

<b>Cable box brand</b>	<b>Code number</b>
Garrard	0153
Gateway	0764
GC Electronics	0207, 0056, 0330, 0016, 0040, 0077, 0030
GE	0232, 0233, 0144, 0021
Gemini	0015, 0070, 0057, 0242, 0014, 0797, 0013, 0400
General Instrument	0476, 0011, 0014, 0098, 0810, 0024, 0003, 0015, 0276
GHZ	0078
Gibraltar	0003
Global	1327
GMI	0069, 0057, 0015, 0797
GoldStar	0144, 0040
Goodmind	0770, 0797
Gradiente	1136
Hamlin	0020, 0009, 0034, 0259, 0015, 0273, 0206
Healthway Interactive	0058, 1020, 1015, 0769
Hitachi	0011, 0154, 0009, 0008, 0003, 0033, 0014, 0255
Houston Tracker	0011
Hwalin	0303
HYTEK	0007
IBM	0670
IIEC	1018
Interbuy	0274
IPC Guest Services	0893
Jasco	0315, 0153, 0015
Jebsee	0014, 0400
Jerrold	0003, 0014, 0276, 0011, 0012, 0020, 0024, 0015, 0047, 0098, 0476, 0031, 0029, 0111, 0032, 0054, 0810, 0028
Kuang Yu	0024
Leon	0069, 0015
LG	0040, 0144
Linsay	0440
Macom	0033

<b>Cable box brand</b>	<b>Code number</b>
Maestro	0812
Magnavox	0797, 0027, 0032, 0334, 0069
Millennium	0618, 0153
Memorex	0000
Mitsubishi	0003
Motorola	0476, 0276, 1476, 0810, 1376, 1254, 0400, 1106
Movie Time	0156, 0078, 0063, 0203
MS	0069, 0015, 1018, 0303
MultiVision	0012
Myrio	1117
NET	0274
Next Level	0764, 1316, 1315, 1314
Nexus	0770
Northcoast	0671, 0314
Nova Vision	0277, 0008
Novabeam	0277
Novaplex	0618, 0277, 0017, 0008
NSC	0156, 0070, 0203, 0063, 0400, 0012, 0618, 0022, 0637, 0010, 0044
Oak	0007, 0019, 0303, 0248, 0017
Omega	0015
Omniview	0371
Optimus	0021
Pace	0237
Pacific Bell	0843
Panasonic	0107, 0021, 0144, 0008, 0124, 0307, 0000, 0040
Panther	0637
Paragon	0000, 0525, 0008
Penney	0637, 0000
Philips	0025, 0031, 0290, 0027, 0030, 0153, 0060, 0242, 0028, 0334, 0211, 0029, 0259, 0307, 0652, 0013, 0069, 0649, 0255, 0305, 0032, 0111, 0317
Pioneer	0144, 0023, 0533, 1877, 0877, 0260

<b>Cable box brand</b>	<b>Code number</b>
Popular Mechanics	0400
Prelude	0770
Prism	0012, 0013, 0059
Protelcon	0786
Pulsar	0000, 0040
Quasar	0000
Quest	0144, 0020
R Line	0040
RadioShack	0883, 0015, 0315, 0303, 0797
Rampage	0255
Ranger	1247
RCA	0021, 0060, 0797, 0047, 1256, 0843
Realistic	0207, 0153
Recoton	0153, 0400
Regal	0259, 0020, 0273, 0279, 0276
Regency	0002, 0020, 0682
Rembrandt	0070, 0153, 0040, 0022, 0011
RK	0304, 0306, 0479
Runco	0000
Samsung	0040, 0144, 0023, 0003, 0070, 0000
Sasktel	1737
Scientific Atlanta	0008, 0277, 0017, 0006, 0237, 0025, 0477, 0207, 0877, 0003, 0012, 0000, 0021, 1877
Seam	0510
Sears	0510
Sejin	1265
Siemens	0246
Sigma	0019
Signal	0040, 0015, 0011, 0035
Signature	0011
SkyCable	0112
Skygiant	1091
SL Marx	0040

<b>Cable box brand</b>	<b>Code number</b>
Sony	1006
Spectradyne	0769, 0058
Spectravision	0058
Sprucer	0021, 0307, 0010, 0144
Standard Components	0203, 0096, 0155
Starcom	0003, 0015, 0047, 0014, 0098, 0305
Stargate	0015, 0040, 0770, 0865, 0797, 0305, 0014
Starquest	0015
StarSight	0542, 0422
Stealth	0274
Stellar One	0807
Storm	1018, 0637
Suena Madritel	1230
Supercable	0276
Supermax	0883
Sylvania	0001
Tandy	0258
Tatung	0097
Teac	1018
Technics	0029
Teknika	0146
Teleavia	0040
TeleCaption	0221
Teleview	0063, 0040
Texscan	0001, 0096, 0010
TFC	0310
Thomson	1256
Timeless	0418, 0274, 0040
Tocom	0012, 0013, 0029, 0019, 0059, 0017
Torx	0003
Toshiba	0000
Trans PX	0303, 0276, 0153, 0315
Trinity	1248
Tristar	0883
TS	0255, 0024, 1018, 0003, 0303

<b>Cable box brand</b>	<b>Code number</b>
Tusa	0015
TV COMM	0035, 0019
TV Guide	1476
TV86	0063, 0040
Uniden	0022, 0225
Unika	0207, 0153, 0022
United Artists	0007
United Cable	0003, 0014, 0011, 0276
Universal	0191, 0078, 0207, 0056, 0022, 0039, 0153, 0077, 0322, 0315
US Electronics	0276, 0008, 0003, 0017
V2	0883
Verizon	0246
Videoway	0250, 0000
VideoWorks	0124
Vidtech	0244
Viewmaster	0883, 0770
Viewstar	0258, 0289, 0060, 0063, 0211, 0027, 0111, 0030, 0121
Vision	0883
Visionetics	1264
Vortex View	0883
WaveMaster	0565
Wiso	0078
Zenith	0000, 0525, 0054, 0017, 0039, 0153, 0060, 0315, 0191, 0899
Zentek	0400

<b>Satellite receiver brand</b>	<b>Code number</b>
AlphaStar	0772
Atlantic Telephone	1333
Bell ExpressVu	0775
Century	0856
Chaparral	0216
Crossdigital	1109
DirecTV	0749, 0566, 0392, 1749, 0099, 1109, 1076, 1442, 1856, 0247, 1142, 1639, 0724, 0639, 0819
Dish Network System	0775, 1005, 1170
Dishpro	0775, 1005
Echostar	0775, 1170, 1005
Expressvu	0775
Galaxis	0863
GE	0566
General Instrument	0361, 0869, 0627
GOI	0775
Gradiente	0856
Hitachi	0819, 0749
Houston Tracker	0775
HTS	0775
Hughes Network Systems	0749, 1749, 1442, 1142
Humax	1176, 1359, 1048, 0863, 0283
Innova	0099
Jerrold	0361, 0036, 0627
JVC	0775, 1170
Magnavox	0722, 0724
McIntosh	0869
Memorex	0724
Mitsubishi	0749
Motorola	0869
NEC	1270, 0496, 0499, 0507, 0508
Netsat	0099
Next Level	0869
Optimus	0724
Panasonic	0247, 0701

<b>Satellite receiver brand</b>	<b>Code number</b>
Paysat	0724
Philips	1076, 0099, 1142, 0724, 0722, 0749, 1442, 1749, 0856, 0775
Primestar	0361, 0627, 0869
Proscan	0392, 0566
QNS	1367
RadioShack	0869
RCA	0566, 0392, 0143, 0855
Samsung	1109, 1276
Sky	0856, 0099, 1856
Sony	0639, 1639
Star Choice	0869
Star Trak	0869, 0772
Thomson	0566, 0392
Tivo	1142, 1442
Toshiba	0790, 0749, 1749, 1285
UEC	1333, 1358
Uniden	0724, 0722
Video Cipher II Plus	0361
Zenith	0856, 1856

---

# Index

Words in quotations appear in the on-screen displays.

## Numerics

- 16:9 24, 98
- 4:3 Letter Box 24, 98
- 4:3 Pan Scan 24, 98

## A

- “A-B Erase” 59
- ADVANCE 35, 70
- ANGLE 35
- AUDIO 35, 73
- “Audio” 104
- “Audio (HDMI)” 101
- Audio cords 18
- “Audio DRC” 101
- Audio settings 100
- Auto Finalize 67, 103
- “Auto Play” 103
- “Auto Repeat” 103

## B

- Batteries 20
- “Black Level” 99
- “Brand Code” 103

## C

- Cable box 13
- Cable box brand 121
- Cable box brand code 121
- “Ch. Digit lock” 104
- Changing or canceling timer settings (Timer List) 53, 79
- “Chapter Erase” 59
- Child Lock 37
- Cleaning discs 112
- Cleaning the video heads 113
- CLEAR 68
- Clock Set settings 97
- “Command Mode” 22, 106
- COMPONENT VIDEO OUT 17

- Connecting
  - the cable box/satellite receiver 12
  - to your AV/amplifier (receiver) 18
  - to your TV 15
- “Connections” 103
- Control for HDMI 16, 104
- Controlling TVs with the remote 21
- Copy protection 48
- Copy-Free 48
- Copy-Never 48
- Copy-Once 48
- Counter 68
- CPRM 30
- “Create Playlist” 63
- Creating chapters 50

## D

- “Digital Out” 100
- “Disc Finalize” 65, 66
- “Disc Format” 65
- “Disc Information” 65
- “Disc Menu” 104
- “Disc Name” 64
- “Disc Protect” 65
- “Disc Setting” 64, 66
- Disc types 30
- Display
  - front panel display 119
  - Setup Display 96
- “Divide Title” 60
- Dolby Digital 100
- “Downmix” 101
- DTS 36, 100
- “Dubbing” 83, 84, 86, 89
- “DV/D8 Audio Input” 87, 102
- “DV/D8 Dubbing” 88
- “DV/D8 Simple Dubbing” 88
- “DVD Auto Chapter” 102
- “DVD Backup” 91
- DVD Editing 57
- DVD VIDEO 32
- DVD+R 30
- DVD+R DL 30
- DVD+RW 30
- DVD-R 30

- DVD-RAM 32
- DVD-RW 30

## E

- Easy Setup 106
- “Edit” 53, 79
- Enter characters 61
- EP mode 74
- “Erase” 53, 59, 79
- “Erase All Titles” 65

## F

- “Factory Setting” 106
- Fast forward 36, 70
- Fast reverse 36, 70
- Feature settings 102
- Finalizing 66
- “Format DVD-RW” 103
- Formatting 48, 64
- “Front Display” 106
- Front panel 116
- Front panel display 119

## H

- Handling discs 112
- HDMI 16
  - “Resolution (HDMI)” 98

## I

- i.LINK 86, 115
- INPUT 49, 75, 87

## J

- JPEG image files 42

## L

- “Language” 104
- Language abbreviation 120
- “Language Follow” 104
- LINE 1 IN 13
- LINE 2 IN 27
- “Line Audio Input” 54, 56, 102
- “Line1 Input” 99

- M**  
 MENU 34  
 Menu  
   Top menu 34  
 “Mode for SET button” 104  
 MP3 audio tracks 41
- N**  
 NEXT 35, 70  
 Number buttons 21, 39
- O**  
 ONE-TOUCH DUBBING  
 87, 90, 91, 93  
 On-screen display  
   OPTIONS menu 11  
   Setup Display 96  
   Sub-menu 11  
   System Menu 10  
 OPTIONS 11  
 Options settings 104  
 Original 39  
 ORIGINAL/PLAYLIST 39,  
 58  
 “OSD” language 24, 104
- P**  
 “Parental” 105  
 Parental Control 37  
 Parts and controls 116  
 PAUSE 36, 49, 70, 75  
 PBC 37  
 “Photo Copy” 95  
 “Picture Control” 99  
 PLAY 34, 68  
 Playable discs 32  
 Playback 34, 68  
   JPEG image files 42  
   MP3 audio tracks 41  
   Resume Play 37  
   Slow-motion play 36, 70  
 Playlist 39, 62  
 Power cord 20  
 PREV 35, 70  
 “Progressive” 99  
 “Protect” 59
- Q**  
 Quick Timer 50, 75
- R**  
 Rear panel 119  
 REC 49, 75  
 REC MODE 49  
 Recording 47, 74  
   recordable discs 30  
   recording format 30  
   recording mode 47  
   tape speed 74  
 Recording mode 47, 74  
 Recording time 47, 50  
 Region code 33  
 Remaining time 40, 76  
 Remote 20, 117  
 REPLAY 35, 70  
 Resetting 106  
 Resume Play 37  
 Rotate 43
- S**  
 Safety tab 74  
 Satellite receiver 13  
 Satellite receiver brand code  
 124  
 “Scan Audio” 37, 101  
 Searching  
   for “Chapter” 39  
   for “Title” 39  
   for “Track” 39  
   Time Search 39  
 Set top box control 12, 24,  
 103  
 Set top box controller 12, 25  
 Settings 96  
 Setup Display 96  
 “Simple Dubbing” 84, 85  
 Slide show 43  
 SP mode 74  
 STOP 34, 49, 68, 75  
 Sub-menu 11  
 SUBTITLE 35  
 “Subtitle” 104  
 “Surround” 101  
 SYNCHRO REC 55, 81  
 “Synchro Recording” 55, 80,  
 103
- T**  
 “Tape Length” 103  
 Tape speed 74  
 TIME/TEXT 41, 72  
 TIMER 51, 77  
 Timer List 53, 79  
 Timer recording 51, 77  
   change or cancel 53, 79  
 “Title Erase” 59, 64  
 TITLE LIST 38, 58  
 Title List 38  
 “Title Name” 59, 64  
 TOP MENU 34  
 TRACKING 69  
 Tracking adjustment 69  
 Troubleshooting 107  
 “TV Type” 98
- U**  
 “Unfinalize” 67  
 Unrecordable pictures 48  
 “USB Dubbing” 91
- V**  
 “VCR Function” 103  
 “Video (HDMI)” 98  
 VIDEO CD 32  
 Video mode 30  
 Video settings 98  
 VR mode 30
- Z**  
 Zoom 43

# Índice

Este manual muestra la configuración básica y el funcionamiento de la videograbadora-grabadora de DVD.

Para obtener más información, consulte el manual de instrucciones en inglés.

---

<b>Conexiones y ajustes</b> . . . . .	<b>3</b>
Conexión de la grabadora . . . . .	3
Paso 1: Desembalaje . . . . .	3
Paso 2: Conexión del decodificador de cable/receptor vía satélite (sintonizador) . . . . .	3
Paso 3: Conexión al televisor . . . . .	6
Paso 4: Conexión del cable de alimentación . . . . .	9
Paso 5: Preparación del mando a distancia . . . . .	9
Paso 6: Configuración fácil . . . . .	10

## Funcionamiento básico

---

<b>Reproducción de DVD</b> . . . . .	<b>13</b>
Reproducción de discos . . . . .	13
Opciones de reproducción . . . . .	14
Reproducción de un título de la Lista títulos . . . . .	16

---

<b>Grabación de DVD</b> . . . . .	<b>17</b>
Antes de grabar . . . . .	17
Grabación de DVD desde un equipo conectado que no tiene temporizador . . . . .	18
Grabación con temporizador de DVD desde un equipo conectado . . . . .	20

---

<b>Reproducción de la videograbadora</b> . . . . .	<b>22</b>
Reproducción de una cinta VHS . . . . .	22
Opciones de reproducción . . . . .	23

---

<b>Grabación de la videograbadora</b> . . . . .	<b>24</b>
Antes de grabar . . . . .	24
Grabación de la videograbadora desde un equipo conectado que no tiene temporizador . . . . .	25
Grabación con temporizador de videograbadora desde un equipo conectado . . . . .	26

---

<b>Copiado (CINTA ↔ DVD)</b> . . . . .	<b>28</b>
Copiado de una cinta VHS a un DVD . . . . .	28
Copiado de un DVD a una cinta VHS . . . . .	29



## Conexiones y ajustes

### Conexión de la grabadora

Siga los pasos del 1 al 6 para conectar y realizar los ajustes de la grabadora.

#### Notas

- Enchufe los cables firmemente para prevenir perturbaciones no deseadas.
- Consulte las instrucciones suministradas con los componentes que va a conectar.
- No es posible conectar la grabadora a un televisor que no disponga de toma de entrada de video.
- Asegúrese de desconectar el cable de alimentación de cada componente antes de realizar las conexiones. No conecte el cable de alimentación hasta haber llegado al apartado "Conexión del cable de alimentación" en la página 9.

### Paso 1: Desembalaje

Compruebe que dispone de los siguientes elementos:

- Cable de audio/video  
(clavija fono × 3 ↔ clavija fono × 3) (1)
- Mando a distancia (1)
- Controlador del decodificador (1)
- Pilas de tamaño AA (R6) (2)

### Paso 2: Conexión del decodificador de cable/receptor vía satélite (sintonizador)

Esta grabadora no incluye un sintonizador de televisión.

Para grabar programas de televisión con este dispositivo, es necesario conectarlo a un sintonizador que tenga tomas de salida de audio/video.

Si ha estado utilizando la videgrabadora conectada a una antena, conecte esta grabadora a la videgrabadora mediante un cable de audio/video. De este modo, podrá grabar programas de televisión.

No es posible grabar en esta grabadora si tiene:

- un decodificador de cable o un receptor vía satélite sin salidas de audio/video.
- cable sin decodificador de cable.
- sólo antena (sin cable de televisión).

En los casos mencionados anteriormente, póngase en contacto con la empresa suministradora para consultar si podrían proporcionarle un decodificador de cable o un receptor vía satélite compatible.

### Utilización de la función de control del decodificador de cable/receptor vía satélite

Esta función permite que la grabadora controle el decodificador de cable o el receptor vía satélite mediante el controlador del decodificador suministrado. También es posible utilizar el mando a distancia de la grabadora para cambiar canales en el decodificador de cable/receptor vía satélite, siempre que ambos estén encendidos. Para utilizar la función de control del decodificador de cable/receptor vía satélite, es necesario:

- comprobar el código de marca del decodificador de cable/receptor vía satélite. Consulte "Cable Box/Satellite Receiver Brand Code" en el manual de instrucciones en inglés (página 121).
- conectar el controlador del decodificador (página 4).
- ajustar el número del código de marca y la entrada de la grabadora que está conectada al decodificador de cable/receptor vía satélite (página 10).

Una vez configurado el control del decodificador de cable/receptor vía satélite, compruebe que la grabadora controla correctamente el dispositivo en cuestión (página 12).

# Conexión del decodificador de cable/receptor vía satélite y del controlador del decodificador

Conecte las tomas LINE 1 IN mediante un cable de audio/video.

Con esta conexión, puede grabar cualquier canal del decodificador de cable o receptor vía satélite.

Asegúrese de que el receptor vía satélite o decodificador de cable está encendido.

Para grabar programas por cable o vía satélite, debe hacer coincidir la fuente de entrada de la grabadora (LINE1) con la toma de entrada que está conectada al decodificador de cable o receptor vía satélite (LINE 1 IN).

Coloque el controlador del decodificador cerca del sensor remoto del decodificador de cable/receptor vía satélite.

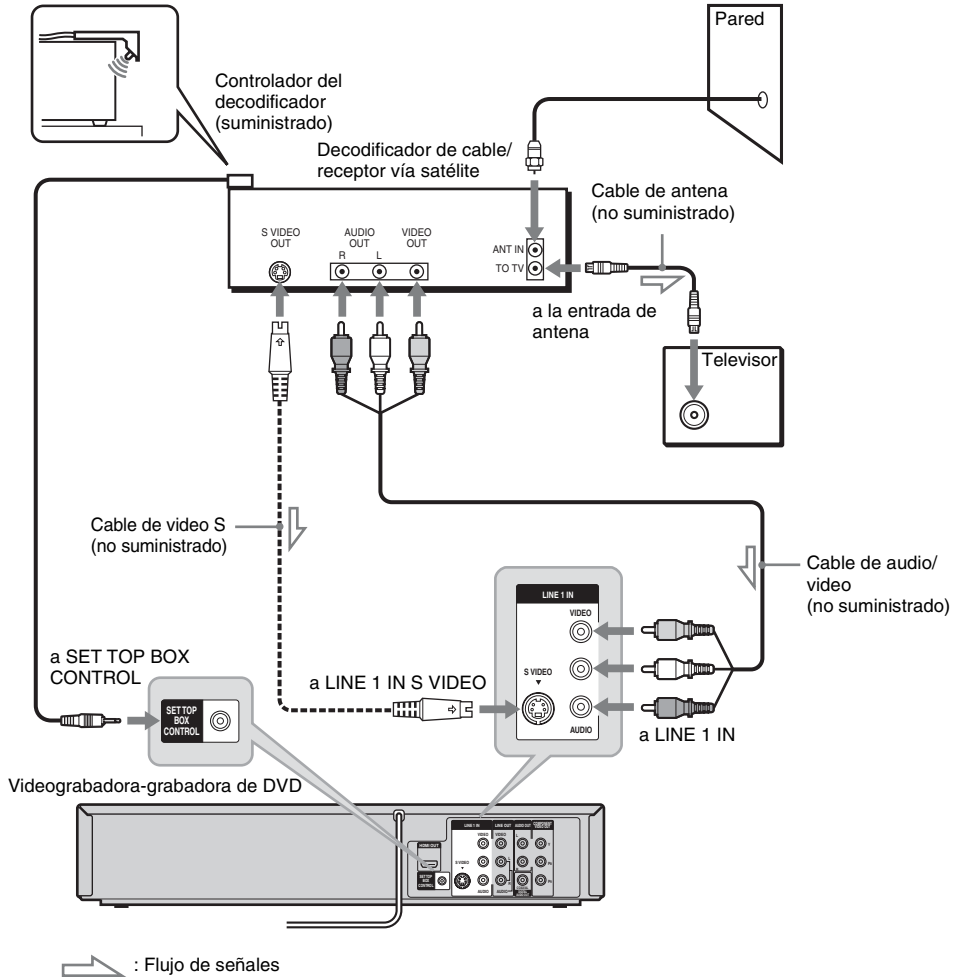

### **Utilización de un cable de video S para disfrutar de una calidad de imagen superior**

Conecte la toma LINE 1 IN S VIDEO mediante un cable de video S (no suministrado) en lugar de la clavija amarilla (video) del cable de audio/video. Deje las clavijas de audio conectadas a las tomas AUDIO L/R. Cuando utilice esta conexión, presione SYSTEM MENU y ajuste "Entrada línea 1" en "Video S" en la configuración de "Video" después de haber completado Configuración fácil (página 10).

#### **Nota**

No conecte las tomas de S VIDEO y VIDEO amarillas al mismo tiempo.

## Paso 3: Conexión al televisor

Conecte el cable de audio/video suministrado a las tomas LINE OUT (VIDEO/AUDIO L/R) de la grabadora.

Si su televisor tiene una toma HDMI, o tomas de entrada de video componente, consulte la página 7 o 8.

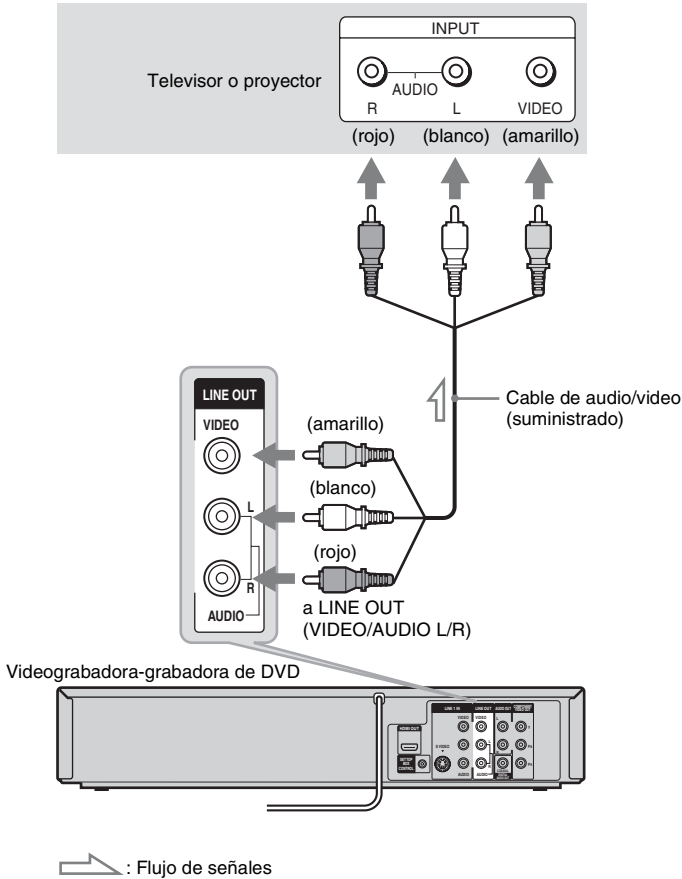

### Nota

No conecte las tomas de salida de audio del televisor a las tomas LINE IN (AUDIO L/R) a la vez. De lo contrario, se producirá ruido no deseado en los altavoces del televisor.

## Si el televisor dispone de una toma de entrada de HDMI

Conecte la toma de salida HDMI\* OUT mediante un cable Sony HDMI certificado (no suministrado). Disfrutará de imágenes y sonido de alta calidad. Si su televisor acepta señales progresivas de 1080p, debe usar esta conexión. El indicador de HDMI se ilumina en la pantalla del panel frontal cuando la grabadora emite señales a través de la toma de salida HDMI OUT. Asegúrese de apagar la grabadora antes de conectar un cable HDMI.

\* Esta grabadora de DVD incorpora la tecnología de High-Definition Multimedia Interface (HDMI™). HDMI, el logotipo de HDMI y High-Definition Multimedia Interface son marcas comerciales o marcas comerciales registradas de HDMI Licensing LLC.

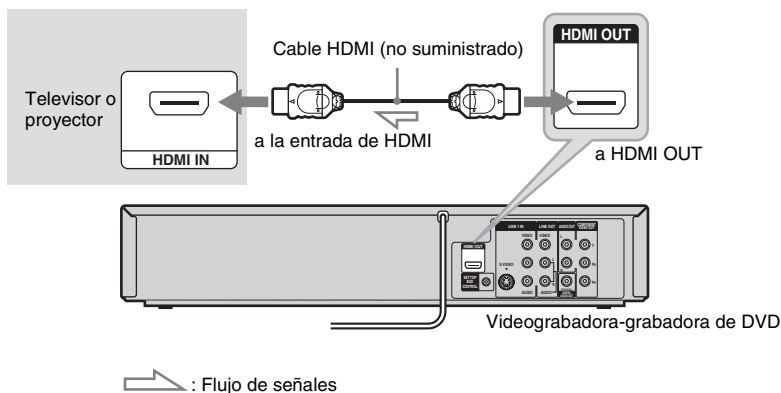

### Notas

- No es posible conectar la toma de salida HDMI OUT a tomas DVI que no sean compatibles con HDCP (por ejemplo, tomas DVI en pantallas de PC).
- Durante la grabación de discos DVD, no es posible visualizar imágenes en VHS mediante la pulsación de VIDEO, ya que la toma de salida HDMI OUT sólo emitirán señales de DVD video.

## Si el televisor tiene tomas de entrada de video componente

Conecte las tomas COMPONENT VIDEO OUT mediante un cable de video componente (no suministrado) o tres cables de video (no suministrados) del mismo tipo y longitud. Disfrutará de una fiel reproducción del color y de imágenes de alta calidad.

Si utiliza esta conexión, asegúrese de conectar el cable de audio a las tomas LINE OUT (AUDIO L/R).

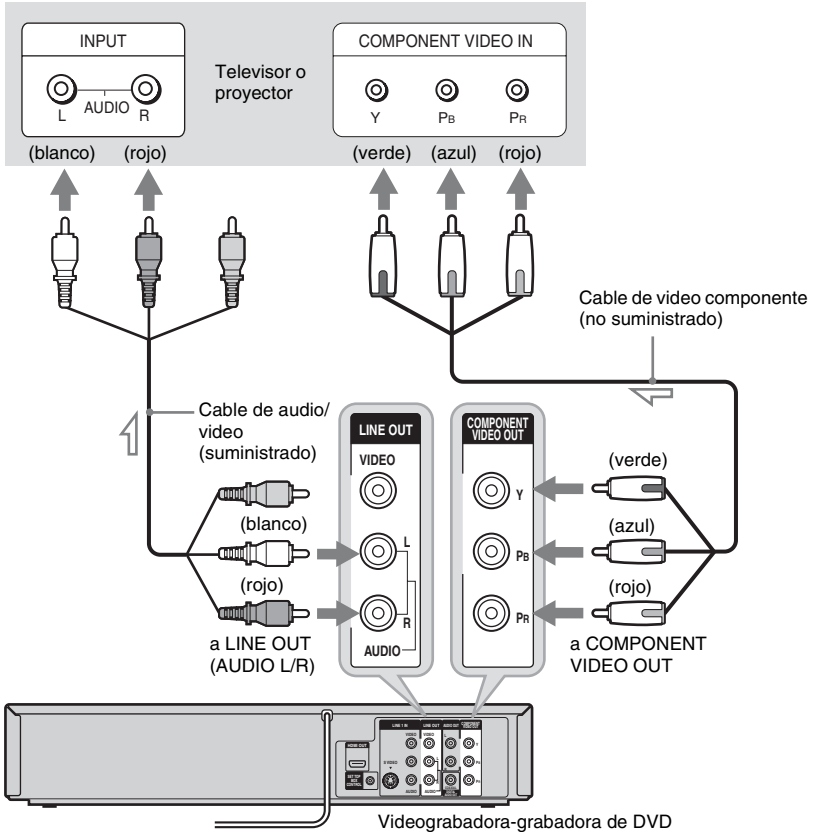

: Flujo de señales

### Nota

Durante la grabación de discos DVD, no es posible visualizar imágenes en VHS mediante la pulsación de VIDEO, ya que las tomas COMPONENT VIDEO OUT sólo emitirán señales de DVD video.

## Paso 4: Conexión del cable de alimentación

Enchufe los cables de alimentación de la grabadora y del televisor a una toma de ca. A continuación, **debe esperar unos instantes antes de utilizar la grabadora**. Podrá utilizarla sólo después de que la pantalla del panel frontal se ilumine y la grabadora pase al modo de espera.



## Paso 5: Preparación del mando a distancia

La grabadora puede controlarse con el mando a distancia suministrado. Inserte dos pilas de tamaño AA (R6) haciendo coincidir sus extremos  $\oplus$  y  $\ominus$  con las marcas del interior del compartimiento de las pilas. Asegúrese de cerrar la tapa de las pilas correctamente. Cuando utilice el mando a distancia, oriéntelo hacia el sensor remoto  de la grabadora.

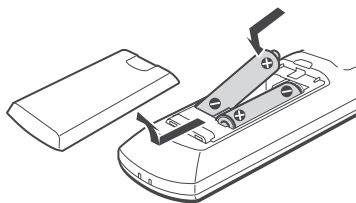

### Notas

- Utilice correctamente las pilas para evitar posibles daños por fugas y corrosión. No toque el líquido directamente con las manos si se produjera alguna fuga. Respete las indicaciones siguientes:
  - No utilice una pila nueva con otra usada, ni pilas de distintos fabricantes.
  - No intente cargar las pilas.
  - Si no tiene intención de utilizar el mando a distancia durante un periodo de tiempo prolongado, extraiga las pilas.
  - Si se produce una fuga de las pilas, seque todo líquido que haya en el compartimiento de las pilas e inserte pilas nuevas.
- No exponga el sensor remoto (marcado con  en el panel frontal) a luz intensa, tal como la luz directa del sol o de aparatos de iluminación. La grabadora podría no responder al control del mando a distancia.
- Con un uso normal, la duración de las pilas es aproximadamente de tres a seis meses.
- No deje el mando a distancia en un lugar excesivamente cálido o húmedo.
- No deje caer ningún objeto extraño dentro de la carcasa del mando a distancia, especialmente cuando reemplace las pilas.

## Paso 6: Configuración fácil

Siga los pasos que se indican a continuación para realizar el mínimo número de ajustes básicos necesarios para utilizar la grabadora. Los ajustes se realizan en el orden siguiente.

Ajuste del idioma de las indicaciones en pantalla



Ajuste del control del decodificador de cable/receptor sat



Ajuste del reloj



Ajuste del tipo de televisor



**Fin**

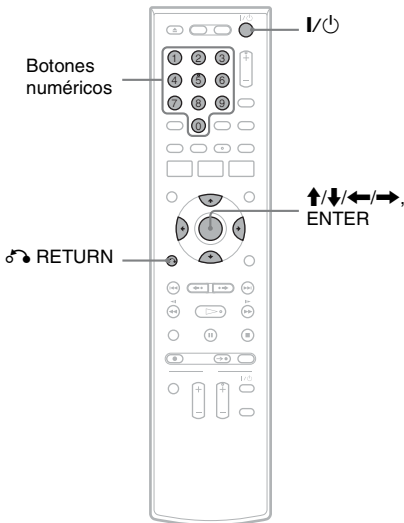

**1 Encienda el televisor.**

**2 Presione I/Power.**

La grabadora se enciende.

**3 Cambie el selector de entrada del televisor para que la señal de la grabadora aparezca en la pantalla del televisor.**

Aparecerá el siguiente mensaje “Initial settings necessary to operate the DVD recorder will be made. You can change them later using setup.” (“Se realizarán los ajustes iniciales necesarios para usar la grabadora DVD. Podrá cambiarlos posteriormente utilizando la configuración.”).

- Si no aparece este mensaje, presione SYSTEM MENU y seleccione “Configuración fácil” en la pantalla “Configuración” para ejecutar la Configuración fácil.

**4 Presione ENTER.**

Aparece la pantalla de configuración que le permite seleccionar el idioma utilizado en las indicaciones en pantalla.

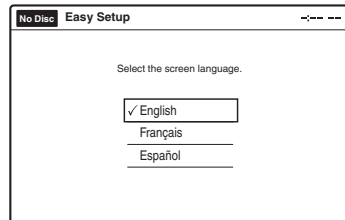

**5 Seleccione un idioma y presione ENTER.**

Aparecerá la pantalla de configuración para el control del decodificador de cable/receptor vía satélite.

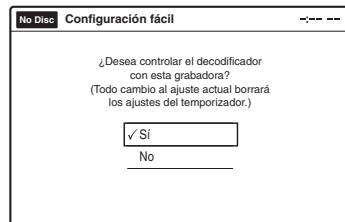

**6 Seleccione si se utiliza o no el control del decodificador de cable/receptor vía satélite; a continuación, presione ENTER.**

Si desea utilizar el control del decodificador de cable/receptor vía satélite (página 3), seleccione “Sí”.

De lo contrario, seleccione “No”, y vaya al paso 9.



## 7 Presione los botones numéricos para introducir el código de marca del decodificador de cable/receptor vía satélite.

Consulte “Cable Box/Satellite Receiver Brand Code” en el manual de instrucciones en inglés (página 121).

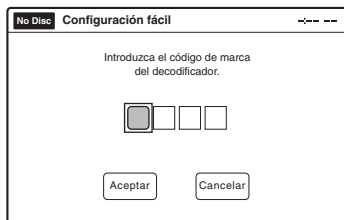

- Para volver a introducir el número del código, seleccione “Cancelar” y vuelva al paso 6.

## 8 Seleccione “Aceptar” y presione ENTER.

Aparecerá la pantalla de configuración para ajustar el reloj.

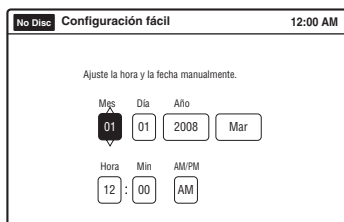

## 9 Presione ↑/↓ para establecer el mes y presione →.

Establezca el día, el año, la hora, los minutos y AM/PM del mismo modo y, a continuación, presione ENTER. El día de la semana se ajusta automáticamente.

Aparecerá la pantalla de configuración para seleccionar el tamaño de la imagen del televisor conectado.

## 10 Seleccione el ajuste que coincida con su tipo de televisor.

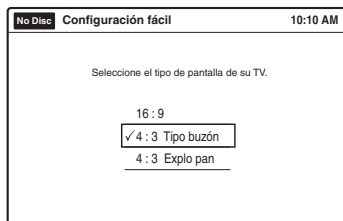

“16:9”: para televisores con pantalla panorámica o televisores con modo panorámico.

“4:3 Tipo buzón”: para televisores de pantalla 4:3.

Muestra imágenes “panorámicas” con franjas en las secciones superior e inferior de la pantalla.

“4:3 Explo pan”: para televisores de pantalla 4:3.

Muestra automáticamente imágenes “panorámicas” que ocupan toda la pantalla y corta las secciones que no caben.

## 11 Presione ENTER.

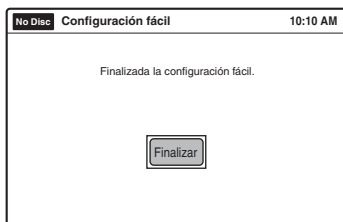

## 12 Presione ENTER cuando aparezca “Finalizar”.

La Configuración fácil ha finalizado. Se han realizado todas las conexiones y operaciones de configuración.

Si utiliza el control de decodificador de cable/receptor vía satélite, compruebe que el control funciona correctamente (página 12).

### Para volver a la indicación anterior

Presione RETURN.

### Observación

Si desea ejecutar la Configuración fácil de nuevo, presione SYSTEM MENU y seleccione “Configuración fácil” en la pantalla “Configuración”.

## Nota

Para grabar programas de televisión utilizando el temporizador, deberá ajustar el reloj con exactitud.

## Comprobar el ajuste de control del decodificador de cable/receptor vía satélite

- 1 Encienda la grabadora y el decodificador de cable/receptor vía satélite.**
- 2 Oriente el mando a distancia de la grabadora hacia ésta (no hacia el decodificador de cable/receptor vía satélite).**
- 3 Presione CH +/- y compruebe que el canal cambia en la ventana del decodificador de cable/receptor vía satélite.**
- 4 Presione los botones numéricos y compruebe que el canal cambia en la ventana del decodificador de cable/receptor vía satélite.**

### Si no consigue que la grabadora controle el decodificador de cable/receptor vía satélite

Vuelva a ejecutar la Configuración fácil y compruebe los ajustes (página 10). Compruebe la conexión y coloque el controlador del decodificador cerca del decodificador de cable/receptor vía satélite (página 3). Si el decodificador de cable/receptor vía satélite sigue sin funcionar correctamente con la grabadora, póngase en contacto con la empresa suministradora para que le proporcionen un decodificador de cable o receptor vía satélite compatible.

### Arreglar el controlador del decodificador para el decodificador de cable/receptor vía satélite

Una vez confirmado que el controlador del decodificador controla el decodificador de cable o receptor vía satélite, colóquelo en su sitio.

- 1** Coloque la cinta de doble capa suministrada en el controlador del decodificador. Retire las partes de apoyo de la cinta de doble capa.



- 2** Colóquelo de manera que el controlador del decodificador esté cerca del sensor de control remoto del decodificador de cable/receptor vía satélite.

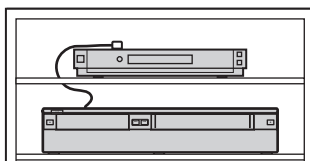

## Reproducción de DVD

# Reproducción de discos

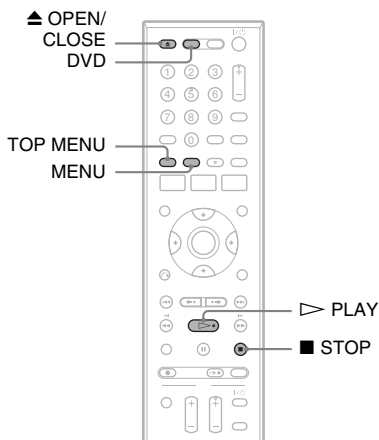

- 1 Presione **DVD** para utilizar la grabadora de DVD.
- 2 Presione **▲ OPEN/CLOSE** y coloque un disco en la bandeja de discos.

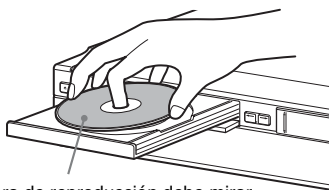

La cara de reproducción debe mirar hacia abajo

- 3 Presione **▲ OPEN/CLOSE** para cerrar la bandeja de discos.  
Espere hasta que "LOAD" desaparezca de la pantalla del panel frontal.
- 4 Presione **▷ PLAY**.  
Se inicia la reproducción.

### Para detener la reproducción

Presione **■ STOP**.

### ⚠ Observaciones

- Es posible reproducir DATA CD o DATA DVD con pistas de audio en formato MP3 o archivos de imagen en formato JPEG.
- Si inserta un DVD VIDEO, VIDEO CD o un CD, la reproducción se iniciará automáticamente en función del disco.
- Al reproducir un DVD+RW, DVD-RW, DVD+R, DVD-R y DVD-RAM, podrá seleccionar el título del menú Lista títulos (página 16).
- Cuando utilice un DVD-RAM con un cartucho, extraiga el disco del mismo.

### Nota

Para reproducir un disco grabado con otro equipo en esta grabadora, primero finalice el disco en el equipo de grabación.

### Utilización del menú del DVD



Cuando reproduzca un DVD VIDEO, o un DVD+RW, DVD-RW (Modo Video), DVD+R o DVD-R (Modo Video) finalizado, podrá acceder al menú del disco presionando **TOP MENU** o **MENU**.

# Opciones de reproducción

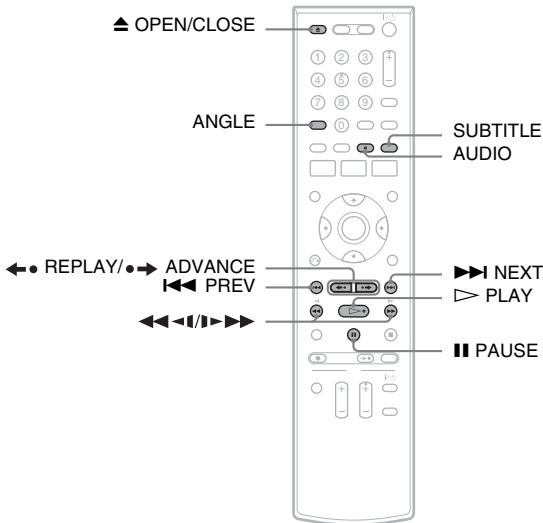

Botón	Operación	Disco
▲ OPEN/CLOSE	Detiene la reproducción y abre la bandeja de discos.	Todos los discos
AUDIO	<p>Selecciona una de las pistas de audio grabadas en el disco cuando se presiona varias veces.</p> <p><b>-RWVR</b> <b>-RVR</b> : selecciona el sonido principal o secundario.</p> <p><b>DVD</b> : selecciona la fuente de audio.</p> <p><b>VCD</b> : selecciona las pistas de audio estéreo o monoaurales.</p>	<b>-RWVR</b> <b>-RVR</b> <b>DVD</b> <b>VCD</b>
SUBTITLE	Selecciona el idioma de los subtítulos cuando se presiona varias veces.	<b>DVD</b>
ANGLE	Selecciona un ángulo cuando se presiona varias veces. Si se grabaron varios ángulos (multiángulo) de una escena en el disco, aparece "0/4" en la pantalla del televisor durante unos pocos segundos. Consulte las instrucciones suministradas con el disco para obtener más información.	<b>DVD</b>
◀• REPLAY/ •▶ ADVANCE	<ul style="list-style-type: none"> <li>Vuelve a reproducir o avanza rápidamente una escena si se presiona durante la reproducción.</li> <li>Se desplaza al fotograma anterior o siguiente si se presiona en el modo de pausa.</li> </ul>	<b>+RW</b> <b>-RWVR</b> <b>-RWVideo</b> <b>+R</b> <b>-RVR</b> <b>-RVideo</b> <b>DVD</b> <b>RAM</b>

Botón	Operación	Disco
<p>◀◀ PREV/ ▶▶ NEXT</p>	<ul style="list-style-type: none"> <li>• Se desplaza al principio del título/capítulo/escena/pista actual o siguiente e inicia la reproducción cuando se presiona durante la reproducción.</li> <li>• Se desplaza al principio del título/capítulo/escena/pista anterior si se presiona ◀◀PREV en los 3 segundos posteriores al inicio de un título/capítulo/escena/pista.</li> </ul>	<p>Todos los discos</p>
<p>◀◀◀◀/▶▶▶▶ (retroceso rápido/ avance rápido)</p>	<p>Avanza o retrocede rápidamente el disco cuando se presiona durante la reproducción. La velocidad de búsqueda cambia cada vez que presiona el botón:</p> <p style="text-align: center;">retroceso rápido      avance rápido</p> <p style="text-align: center;">FR1 ◀      → FF1*<sup>1</sup></p> <p style="text-align: center;">FR2*<sup>2</sup> ◀◀      →→ FF2*<sup>2</sup></p> <p style="text-align: center;">FR3*<sup>3</sup> ◀◀◀      →→→ FF3*<sup>3</sup></p>	<p>Todos los discos</p> <p>*<sup>1</sup> FF1 con sonido (Explorar audio) está disponible para DVD con pistas de sonido Dolby Digital.</p> <p>*<sup>2</sup> FR2 y FF2 no están disponibles para MP3.</p> <p>*<sup>3</sup> FR3 y FF3 sólo están disponibles para DVD y VIDEO CD.</p>
<p>◀◀◀◀/▶▶▶▶ (lento)</p>	<p>Reproduce a cámara lenta cuando se presiona en el modo de pausa. La velocidad de reproducción cambia cada vez que se presiona el botón:</p> <p style="text-align: center;">retroceso a cámara lenta      avance a cámara lenta</p> <p style="text-align: center;">◀◀◀ 3 ◀      → 3 ▶▶▶</p> <p style="text-align: center;">◀◀ 2 ◀◀      →→ 2 ▶▶▶</p> <p style="text-align: center;">◀◀ 1 ◀◀◀      →→→ 1 ▶▶▶</p>	<p style="text-align: center;"> <span style="border: 1px solid black; padding: 2px;">+RW</span>   <span style="border: 1px solid black; padding: 2px;">-RWVR</span>   <span style="border: 1px solid black; padding: 2px;">-RWVideo</span>  <span style="border: 1px solid black; padding: 2px;">+R</span>   <span style="border: 1px solid black; padding: 2px;">-RVR</span>   <span style="border: 1px solid black; padding: 2px;">-RVideo</span>  <span style="border: 1px solid black; padding: 2px;">DVD</span>   <span style="border: 1px solid black; padding: 2px;">RAM</span>   <span style="border: 1px solid black; padding: 2px;">VCD</span>*         </p> <p>* Sólo dirección de reproducción</p>
<p>⏸ PAUSE</p>	<p>Hace una pausa en la reproducción. Si ésta dura más de cinco minutos, la reproducción se inicia automáticamente.</p>	<p>Todos los discos</p>

Para reanudar la reproducción normal después de reproducir a diferentes velocidades, presione ▷▶ PLAY.

# Reproducción de un título de la Lista títulos

+RW -RWVR -RWVideo +R -RVR -RVideo

RAM

El menú Lista títulos muestra los títulos de los programas del disco.

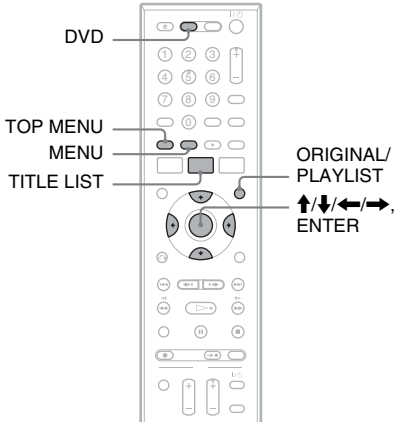

- 1 Presione DVD para utilizar la grabadora de DVD.
- 2 Coloque un disco en la bandeja de discos.
- 3 Presione TITLE LIST.

Ejemplo: DVD-RW (modo VR)

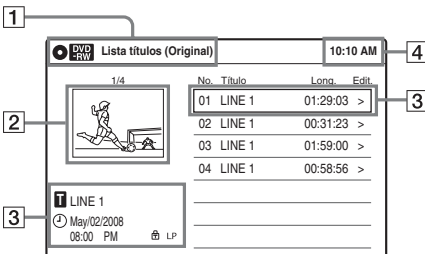

- 1 Tipo de disco:  
Muestra el tipo de disco.  
También muestra los tipos de título (original o Playlist) para DVD-RW (Modo VR), DVD-R (Modo VR) y DVD-RAM.
- 2 Imagen en miniatura de película

- 3 Información del título:  
Muestra el número del título, su nombre, la fecha y el modo de grabación.  
"Ⓜ" indica que se trata de un título protegido, mientras que "Ⓛ" indica que está desprotegido.

- 4 Reloj

- 5 Seleccione el título y presione ENTER.  
Aparece el submenú.

- 5 Seleccione "Reproducir" y presione ENTER.

La reproducción comienza desde el título seleccionado en el disco.

## Acerca de las listas de títulos para DVD-RW (Modo VR) y DVD-R (Modo VR)

Es posible cambiar la lista de títulos para que se muestre un título original o una Playlist.

Presione ORIGINAL/PLAYLIST varias veces mientras se muestra el menú Lista títulos para seleccionar "Lista títulos (Original)" o "Playlist".

## Para quitar la lista de títulos

Presione TITLE LIST.

## Observación

También es posible cambiar la lista de títulos de DVD-RAM para mostrar un original o Playlist.

## Notas

- La lista de títulos no aparece con DVD-RW (Modo Video), DVD+R o DVD-R (Modo Video) que hayan finalizado. Para visualizar un título, presione TOP MENU o MENU (página 13).
- Es posible que la lista de títulos no aparezca en discos creados en otras grabadoras de DVD.
- Las letras que no pueden mostrarse se reemplazan por "\*".

## Antes de grabar

### Antes de empezar la grabación...

Compruebe que la grabadora está conectada a un sintonizador como, por ejemplo, un decodificador de cable o receptor vía satélite (página 3).

Consulte también el manual de instrucciones del sintonizador.

### Número máximo de títulos grabables

Disco	Número de títulos
DVD-RW/DVD-R	99
DVD+RW/DVD+R	49
DVD+R DL	49

## Modo de grabación

Esta grabadora dispone de ocho modos de grabación distintos, al igual que los modos de grabación SP o EP de las videograbadoras. Seleccione el modo de grabación en función del tiempo y la calidad de imagen deseada. Por ejemplo, si la calidad de la imagen es su principal prioridad, seleccione el modo "HQ" (alta calidad). Si su principal prioridad es el tiempo de grabación, el modo "SLP" puede ser su alternativa.

### Presione REC MODE varias veces para cambiar los modos de grabación.

Deseo grabar con la mejor calidad de imagen posible, por eso seleccionaré HQ.



## Modo de grabación y tiempo de grabación

La siguiente tabla es una guía aproximada del tiempo de grabación en un DVD (4,7 GB).

Modo de grabación	Tiempo de grabación (minutos) aproximado
HQ (alta calidad)	60
HSP ↑	90
SP (Modo estándar)	120
LSP ↓	150
ESP ↓	180
LP ↓	240
EP ↓	360
SLP (Larga duración)	480

### 🔔 Observación

El tiempo de grabación aproximado para los discos DVD+R DL (doble capa) es el que se indica a continuación:

HQ: 1 hora y 48 minutos

HSP: 2 horas y 42 minutos

SP: 3 horas y 37 minutos

LSP: 4 horas y 31 minutos

ESP: 5 horas y 25 minutos

LP: 7 horas y 14 minutos

EP: 10 horas y 51 minutos

SLP: 14 horas y 28 minutos

## Notas

- En modos de grabación distintos a HQ, la grabadora comprime los datos de audio/video antes de la grabación. Dado que las escenas de movimientos rápidos o la existencia de ruido en la imagen requieren que las tasas de compresión disminuyan, el tamaño de los datos grabados aumenta y el tiempo de grabación disponible se acorta. En la grabación de estas imágenes, se recomienda un modo de grabación que proporcione un tiempo de grabación más largo.
- Los siguientes casos pueden producir inexactitudes en el tiempo de grabación.
  - Grabación de imágenes con ruido de imagen o escenas de movimiento rápido.
  - Grabación de un programa con recepción defectuosa, o una fuente de programa o video con imagen de baja calidad
  - Grabación en un disco ya editado
  - Grabación de imágenes fijas o sonido únicamente
- Debido a que el modo de grabación de títulos grabados se calcula después del muestreo de datos grabados durante la reproducción, es posible que se muestre diferente del modo que seleccionó durante la grabación. Sin embargo, la grabación real se realizó correctamente en el modo seleccionado.

## Imágenes que no pueden grabarse

En esta grabadora no pueden grabarse imágenes con protección contra copias. La grabación se detiene cuando se detecta una señal de protección contra copias.

Señales de control de copias	Discos grabables
Copy-Free	+RW -RWVR -RWVideo +R -RVR -RVideo
Copy-Once <sup>*1</sup>	-RWVR (CPRM <sup>*2</sup> ) -RVR (CPRM <sup>*2</sup> )
Copy-Never	Ninguna

\*1 No se puede grabar en discos DVD disponibles normalmente que no sean compatibles con CPRM.

\*2 El disco grabado sólo puede reproducirse en un equipo compatible con CPRM.

## Grabación de DVD desde un equipo conectado que no tiene temporizador

+RW -RWVR -RWVideo +R -RVR -RVideo

Es posible grabar programas de televisión en la grabadora a través del decodificador de cable/receptor vía satélite conectado.

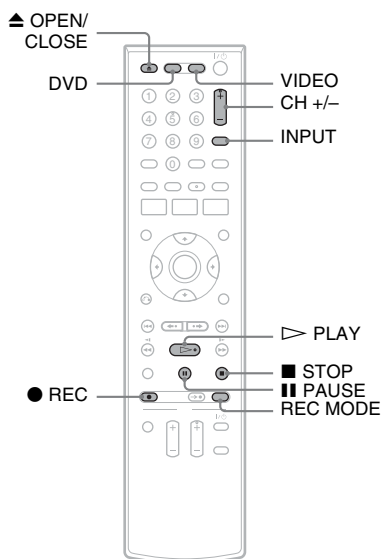

- 1 Encienda la grabadora y el decodificador de cable/receptor vía satélite.
- 2 Presione DVD para utilizar la grabadora de DVD.
- 3 Presione ▲ OPEN/CLOSE y coloque un disco grabable en la bandeja de discos.

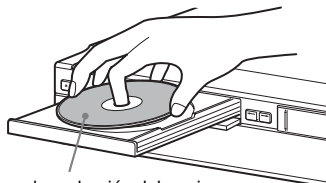

La cara de grabación debe mirar hacia abajo

- 4 Presione ▲ OPEN/CLOSE para cerrar la bandeja de discos.

Espere hasta que "LOAD" desaparezca de la pantalla del panel frontal.



## 5 Presione CH +/- o INPUT varias veces para seleccionar el canal o la fuente de entrada que desea grabar.

- Cuando utilice el control de decodificador de cable/receptor vía satélite, seleccione el canal presionando CH +/- en el mando a distancia de esta grabadora. La entrada de la grabadora se cambia a la entrada conectada (LINE1 o LINE2). También es posible utilizar los botones numéricos.
- Cuando no utilice el control de decodificador de cable/receptor vía satélite, seleccione la entrada conectada (LINE1 o LINE2) presionando INPUT y, a continuación, seleccione el canal en el decodificador de cable/receptor vía satélite.

## 6 Presione REC MODE varias veces para seleccionar el modo de grabación.

La pantalla cambiará en la pantalla del televisor del modo de grabación siguiente:

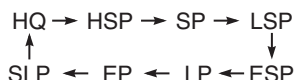

Para obtener más detalles sobre el modo de grabación, consulte la página 17.

## 7 Presione ● REC.

Comienza la grabación.

La grabación continúa hasta que usted la detiene o el disco se llena.

Deje el decodificador de cable/receptor vía satélite encendido y no cambie el canal que está grabando.

### Para detener la grabación

Presione ■ STOP.

Tenga en cuenta que la grabadora demora algunos segundos en detener la grabación.

### Para hacer una pausa en la grabación

Presione ■ PAUSE.

Para reiniciar la grabación, presione ■ PAUSE de nuevo.

### Para ver una cinta VHS durante la grabación

Presione VIDEO para utilizar la videograbadora, inserte una cinta y, a continuación, presione

▷ PLAY.

## Notas

- Es posible que la grabación no se inicie inmediatamente después de presionar ● REC.
- No se puede cambiar el modo de grabación mientras graba o durante una pausa de grabación.
- Si se produce un corte en el suministro eléctrico, se eliminará el programa que se está grabando.
- No es posible cambiar la fuente de entrada durante la grabación.

## Grabación mediante la función Quick Timer (Grabación con temporizador presionando un solo botón)

Puede ajustar la grabadora para que grabe en incrementos de 30 minutos.

### 1 Presione DVD para utilizar la grabadora de DVD.

### 2 Presione ● REC varias veces para definir la duración.

Cada vez que presione el botón, aumentará el tiempo en 30 minutos, hasta un máximo de ocho horas\*.

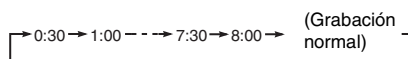

“⊙” y “OTR” se iluminan y el tiempo de grabación restante aparece en la pantalla del panel frontal.

Cuando el contador llega a “0:00”, la grabadora detiene la grabación y se apaga.

\* 14 horas 30 minutos para discos DVD+R DL (doble capa).

### Para cancelar el Quick Timer

Presione ● REC varias veces hasta que aparezca el contador en la pantalla del panel frontal. La grabadora vuelve al modo de grabación normal.

### Para detener la grabación

Presione ■ STOP dos veces.

Tenga en cuenta que la grabadora demora algunos segundos en detener la grabación.

# Grabación con temporizador de DVD desde un equipo conectado

+RW -RWVR -RWVideo +R -RVR -RVideo

Puede ajustar el temporizador para un total de 12 programas utilizando la grabación de DVD con temporizador y la grabación de videograbadora con temporizador con un máximo de un mes de anticipación.

Tenga en cuenta que el tiempo de grabación continua máximo de un único título es de 12 horas. El contenido que supere este tiempo no se grabará.

## Nota

No opere el decodificador de cable ni el receptor vía satélite justo antes ni durante una grabación con temporizador, ya que ello puede impedir la grabación correcta de un programa.

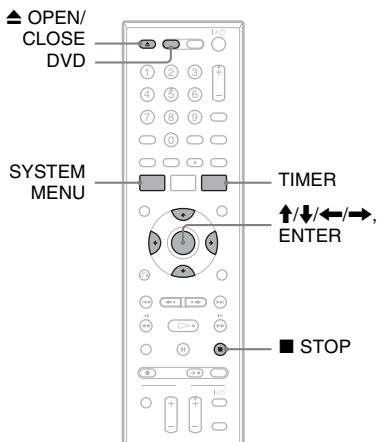

**1** Presione DVD para utilizar la grabadora de DVD.

**2** Presione  $\triangle$  OPEN/CLOSE y coloque un disco grabable en la bandeja de discos.



La cara de grabación debe mirar hacia abajo

**3** Presione  $\triangle$  OPEN/CLOSE para cerrar la bandeja de discos.

Espere hasta que "LOAD" desaparezca de la pantalla del panel frontal.

**4** Presione TIMER.

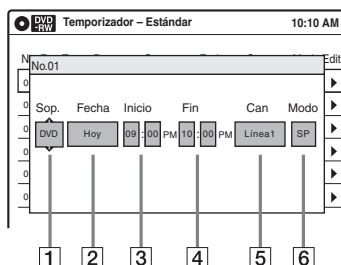

**5** Seleccione un elemento utilizando  $\leftarrow/\rightarrow$  y ajústelo utilizando  $\uparrow/\downarrow$ .

**1** "Sop.": seleccione "DVD".

**2** "Fecha": ajusta la fecha mediante  $\uparrow$ .

Para grabar el mismo programa todos los días o el mismo día todas las semanas, presione  $\downarrow$ .

El elemento cambia de la siguiente manera:

Hoy  $\leftrightarrow$  Dom-Sáb (de domingo a sábado)

$\leftrightarrow$  Lun-Sáb (de lunes a sábado)  $\leftrightarrow$

Lun-Vie (de lunes a viernes)  $\leftrightarrow$

Dom (todos los domingos)  $\leftrightarrow$

Lun (todos los lunes)  $\leftrightarrow$  ...  $\leftrightarrow$

Sáb (todos los sábados)  $\leftrightarrow$

1 mes más tarde  $\leftrightarrow$  ...  $\leftrightarrow$  Hoy

**3** "Inicio": establece la hora de inicio.

**4** "Fin": establece la hora de finalización.

**5** "Can": selecciona el canal o la fuente de entrada.

- Cuando utilice el control de decodificador de cable/receptor vía satélite, seleccione el canal.

- Cuando no utilice el control de decodificador de cable/receptor vía satélite, seleccione la entrada, LINE1 o LINE2. Seleccione el canal en el decodificador de cable/receptor vía satélite conectado antes de iniciar la grabación con temporizador.

- 6 “Modo”: selecciona el modo de grabación (página 17).  
Para utilizar la función Ajustar modo grab. (página 21), seleccione “AUTO”.

Si se equivoca, seleccione el elemento y cambie el ajuste.

## 6 Presione ENTER.

Aparecerá el menú Lista de temporizador. Se ilumina el indicador ⊕ en la pantalla del panel frontal, y la grabadora está lista para comenzar a grabar.

- Si parpadea el indicador ⊕ en la pantalla del panel frontal, compruebe que hay un disco grabable insertado y que en el disco hay suficiente espacio para la grabación.

## 7 Presione SYSTEM MENU para quitar el menú.

No es necesario apagar la grabadora antes de que empiece la grabación con temporizador. Deje el decodificador de cable/receptor vía satélite encendido y no cambie el canal seleccionado hasta que la grabadora finalice la grabación con temporizador.

---

### Para detener la grabación

Presione ■ STOP dos veces.

Tenga en cuenta que la grabadora demora algunos segundos en detener la grabación.

### Para utilizar la función Ajustar modo grab.

Si el espacio restante en el disco no es suficiente para realizar la grabación actual, la grabadora ajustará el modo de grabación automáticamente. Seleccione “AUTO” en “Modo” al ajustar el temporizador.

### Notas

- Aunque lo ajuste correctamente, es posible que el programa no se grabe si se está realizando otra grabación o si se superpone otro ajuste de temporizador con prioridad.
- Antes de comenzar la grabación con temporizador, “TIMER REC” parpadea en la pantalla del panel frontal.
- La grabadora se apaga automáticamente cuando finaliza una grabación con temporizador, incluso aunque la grabación comenzase con la grabadora encendida.
- La grabadora no graba programas con señales Copy- Never. Este tipo de grabaciones se detienen al cabo de unos segundos.

# Reproducción de una cinta VHS

VHS

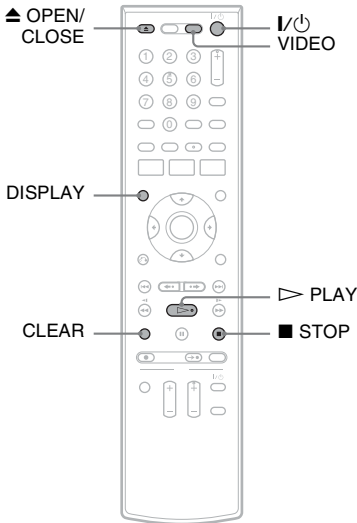

**1** Presione **VIDEO** para utilizar la videograbadora.

**2** Inserte una cinta.

La reproducción comienza automáticamente si inserta una cinta a la que se le ha quitado la lengüeta de protección.

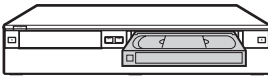

**3** Presione **▶ PLAY**.

La pantalla del panel frontal muestra el tiempo de reproducción.

Cuando la cinta llegue al final, se rebobinará automáticamente.

## Para detener la reproducción

Presione **■ STOP**.

## Para expulsar la cinta

Presione **▲ OPEN/CLOSE**.

## Para desconectar la alimentación durante el rebobinado (parada del rebobinado)

Presione **I/⏻** mientras la cinta se está rebobinando. La alimentación se desactivará pero la cinta seguirá rebobinándose hasta que llegue al final.

## Para emplear el contador de tiempo

Presione **CLEAR** en el punto que desee localizar más tarde. El contador en la pantalla del panel frontal se restablece a "0:00:00".

Para mostrar el contador en la pantalla del televisor, presione **DISPLAY**.

## Notas

- Durante la reproducción, la videograbadora detecta automáticamente el sistema de grabación (S-VHS/VHS) y el modo de grabación (SP o EP) de la cinta. Las grabaciones en modo LP realizadas en otros equipos se reproducirán, pero no se garantiza una buena calidad de la imagen.
- El contador se restablecerá a "0:00:00" siempre que se vuelva a insertar una cinta.
- El contador deja de contar cuando llega a una parte sin grabación.
- El contador se restablecerá a "0:00:00" una vez transcurridas diez horas y se inicia de nuevo la cuenta.
- Si cambia al modo de videograbadora durante la reproducción de un disco, la reproducción del DVD se detendrá.
- La videograbadora no graba en formato S-VHS; sin embargo, reproducirá las cintas S-VHS al detectar automáticamente el formato, aunque la calidad de la imagen será peor de lo normal en S-VHS. Es posible que la imagen no resulte clara si se utilizan opciones de reproducción tales como la cámara lenta, etc.
- No se garantiza la reproducción de las cintas S-VHS grabadas en modo EP (×3).
- La videograbadora no es compatible con el sistema de color PAL o SECAM. Sólo es posible reproducir cintas NTSC.

# Opciones de reproducción

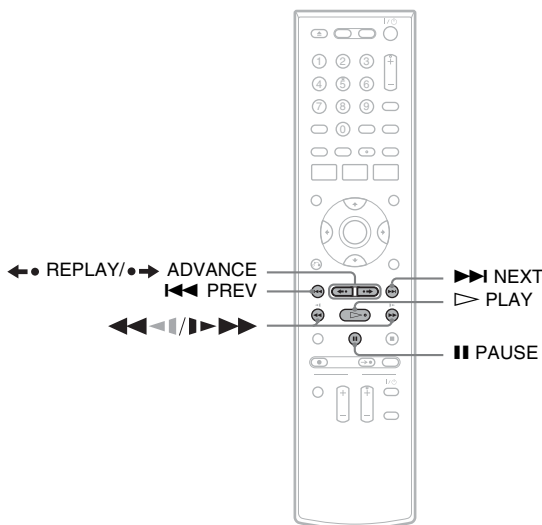

Botón	Operación
 (retroceso rápido/avance rápido)	<ul style="list-style-type: none"> <li>Avanza o retrocede rápidamente si se presiona durante el modo de detención. Si mantiene presionado el botón durante el avance o retroceso rápido, podrá ver la imagen.</li> <li>Reproduce a alta velocidad cuando se presiona brevemente durante la reproducción. Si mantiene presionado el botón durante la reproducción, ésta continúa a alta velocidad hasta que se suelta el botón.</li> </ul>
 (lento)	Reproduce a cámara lenta cuando se presiona en el modo de pausa.
 •→ ADVANCE	<ul style="list-style-type: none"> <li>Avanza un fotograma cada vez que se presiona en modo de pausa.</li> <li>Avanza rápidamente la escena actual durante 30 segundos cuando se presiona durante la reproducción.*1</li> </ul>
 ←• REPLAY	Vuelve a reproducir la escena anterior cuando se presiona durante la reproducción.*2
 PREV/ NEXT	Presiónelo durante la reproducción. La velocidad de reproducción cambia cada vez que se presiona el botón: -x7 ↔ -x5 ↔ -x3 ↔ PAUSE ↔ SLOW ↔ PLAY ↔ x2 ↔ x3 ↔ x5 ↔ x7
    PAUSE	Hace una pausa en la reproducción. Si ésta dura más de cinco minutos, la reproducción se inicia automáticamente.

\*1 Puede presionarse hasta cuatro veces para avanzar aproximadamente dos minutos.

\*2 Durante 10 segundos en modo SP o LP/ durante 15 segundos en modo EP.

Para reanudar la reproducción normal, presione  
 PLAY.

## Notas

- El sonido se enmudece durante la reproducción a varias velocidades.
- Es posible que aparezca ruido durante la reproducción inversa a alta velocidad.

## Grabación de la videograbadora

### Antes de grabar

#### Antes de empezar la grabación...

Compruebe que la grabadora está conectada a un sintonizador como, por ejemplo, un decodificador de cable o receptor vía satélite (página 3).

Consulte también el manual de instrucciones del sintonizador.

#### Nota

La grabadora dispone de función de protección contra copia. Los programas que incluyen señales de protección contra copias del tipo Copy-Never no pueden grabarse correctamente en la videograbadora.

#### Para proteger grabaciones contra el borrado

Para evitar borrados accidentales, rompa la lengüeta de seguridad como muestra la ilustración. Para volver a grabar en la cinta, cubra el orificio de la lengüeta con cinta adhesiva.

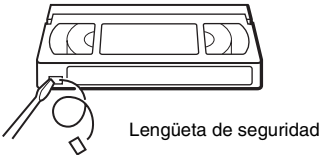

### Modo de grabación

Los modos “EP” (reproducción extendida) y “SP” (reproducción estándar) están disponibles en el modo de grabación (velocidad de cinta). El modo “EP” proporciona un tiempo de grabación tres veces superior a la duración del modo “SP”. No obstante, se obtiene una mejor calidad de imagen y sonido con el modo “SP”.

#### Tiempo máximo de grabación

Longitud de cinta	SP	EP
T-120	2 horas	6 horas
T-160	2 horas y 40 minutos	8 horas
T-180	3 horas	9 horas

#### Notas

- Las cintas grabadas en modo EP (×3) con esta videograbadora no pueden reproducirse en pletinas de video VHS que sólo tengan modo SP.
- Cuando se reproduzcan cintas grabadas en el modo EP (×3) con esta videograbadora en otras pletinas de video VHS con el modo EP, es posible que aparezca ruido en la imagen.

# Grabación de la videograbadora desde un equipo conectado que no tiene temporizador

VHS

Es posible grabar programas de televisión en la grabadora a través del decodificador de cable/receptor vía satélite conectado.

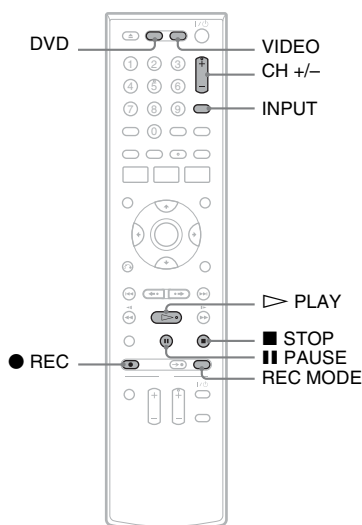

- 1 Encienda la grabadora y el decodificador de cable/receptor vía satélite.
- 2 Presione VIDEO para utilizar la videograbadora.
- 3 Inserte una cinta provista de lengüeta de seguridad.

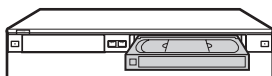

## 4 Presione CH +/- o INPUT varias veces para seleccionar el canal o la fuente de entrada que desee grabar.

- Cuando utilice el control de decodificador de cable/receptor vía satélite, seleccione el canal presionando CH +/- en el mando a distancia de esta grabadora. La entrada de la grabadora se cambia a la entrada conectada (LINE1 o LINE2). También es posible utilizar los botones numéricos.
- Cuando no utilice el control de decodificador de cable/receptor vía satélite, seleccione la entrada conectada (LINE1 o LINE2) presionando INPUT y, a continuación, seleccione el canal en el decodificador de cable/receptor vía satélite.

## 5 Presione REC MODE varias veces para seleccionar el modo de grabación, "SP" o "EP".

Para obtener más detalles sobre el modo de grabación, consulte la página 24.

## 6 Presione ● REC.

Aparece "REC" en la pantalla del panel frontal y se inicia la grabación. Deje el decodificador de cable/receptor vía satélite encendido y no cambie el canal que está grabando.

### Para detener la grabación

Presione ■ STOP.

### Para hacer una pausa en la grabación

Presione || PAUSE.

Para reiniciar la grabación, presione || PAUSE de nuevo.

Si hace una pausa en la grabación de más de cinco minutos, ésta se detiene automáticamente.

### Para ver un DVD durante la grabación

Presione DVD para utilizar la grabadora, inserte un disco y, a continuación, presione ▷ PLAY.

### Notas

- No es posible cambiar el modo de grabación, el canal ni la fuente de entrada durante la grabación.
- Si inserta una cinta a la que se haya quitado la lengüeta de seguridad, ésta se expulsará cuando presione ● REC.

## Grabación mediante la función Quick Timer (Grabación con temporizador presionando un solo botón)

Puede ajustar la grabadora para que grabe en incrementos de 30 minutos.

- 1 Presione **VIDEO** para utilizar la videgrabadora.
- 2 Presione **● REC** varias veces para definir la duración.

Cada vez que se presione el botón, el tiempo aumentará en 30 minutos, hasta un máximo de seis horas.

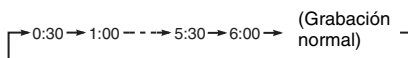

“☺” y “OTR” se iluminan y el tiempo de grabación restante aparece en la pantalla del panel frontal.

Cuando el contador llega a “0:00”, la grabadora detiene la grabación y se apaga.

### Para cancelar el Quick Timer

Presione **● REC** varias veces hasta que aparezca el contador en la pantalla del panel frontal. La grabadora vuelve al modo de grabación normal.

### Para detener la grabación

Presione **■ STOP** dos veces.

## Grabación con temporizador de videgrabadora desde un equipo conectado

### VHS

Puede ajustar el temporizador para un total de 12 programas utilizando la grabación de DVD con temporizador y la grabación de videgrabadora con temporizador con un máximo de un mes de anticipación.

### Nota

No opere el decodificador de cable ni el receptor vía satélite justo antes ni durante una grabación con temporizador, ya que ello puede impedir la grabación correcta de un programa.

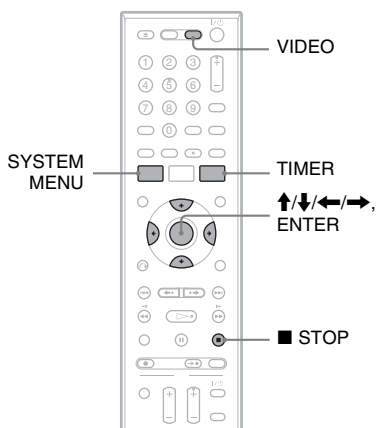

- 1 Presione **VIDEO** para utilizar la videgrabadora.
- 2 Inserte una cinta provista de lengüeta de seguridad.

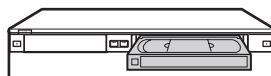



### 3 Presione TIMER.

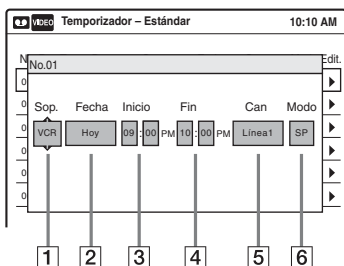

### 4 Seleccione un elemento utilizando ←/→ y ajústelo utilizando ↑/↓.

- 1 “Sop.”: seleccione “VCR.”
- 2 “Fecha”: ajusta la fecha mediante ↑.  
Para grabar el mismo programa todos los días o el mismo día todas las semanas, presione ↓.  
El elemento cambia de la siguiente manera:  
Hoy ↔ Dom-Sáb (de domingo a sábado)  
↔ Lun-Sáb (de lunes a sábado) ↔  
Lun-Vie (de lunes a viernes) ↔  
Dom (todos los domingos) ↔  
Lun (todos los lunes) ↔ ... ↔  
Sáb (todos los sábados) ↔  
1 mes más tarde ↔ ... ↔ Hoy
- 3 “Inicio”: establece la hora de inicio.
- 4 “Fin”: establece la hora de finalización.
- 5 “Can”: selecciona el canal o la fuente de entrada.
  - Cuando utilice el control de decodificador de cable/receptor vía satélite, seleccione el canal.
  - Cuando no utilice el control de decodificador de cable/receptor vía satélite, seleccione la entrada, LINE1 o LINE2. Seleccione el canal en el decodificador de cable/receptor vía satélite conectado antes de iniciar la grabación con temporizador.
- 6 “Modo”: selecciona el modo de grabación; “SP” o “EP”. Para utilizar la función Ajustar modo grab. (página 27), seleccione “AUTO”.

Si se equivoca, seleccione el elemento y cambie el ajuste.

### 5 Presione ENTER.

Aparecerá el menú Lista de temporizador. Se ilumina el indicador ☹ en la pantalla del panel frontal, y la grabadora está lista para comenzar a grabar.

- Si el indicador ☹ parpadea en la pantalla del panel frontal, compruebe que ha insertado una cinta con la lengüeta de seguridad intacta.

### 6 Presione SYSTEM MENU para quitar el menú.

No es necesario apagar la grabadora antes de que empiece la grabación con temporizador. Deje el decodificador de cable/receptor vía satélite encendido y no cambie el canal seleccionado hasta que la grabadora finalice la grabación con temporizador.

### Para detener la grabación

Presione ■ STOP dos veces.

### Para utilizar la función Ajustar modo grab.

Si la longitud restante de la cinta es demasiado corta para la grabación actual, la videograbadora cambiará automáticamente el modo de grabación de SP a EP.

Cuando ajuste el temporizador, seleccione “AUTO” en “Modo”. Presione SYSTEM MENU y ajuste “Longitud de cinta” - “Función videograbadora” de “Características” en la pantalla “Configuración”.

### Notas

- Aunque lo ajuste correctamente, es posible que el programa no se grabe si se está realizando otra grabación o si se superpone otro ajuste de temporizador con prioridad.
- No es posible grabar en una cinta a la que se le haya quitado la lengüeta de seguridad.
- Antes de comenzar la grabación con temporizador, “TIMER REC” parpadea en la pantalla del panel frontal.
- La grabadora se apaga automáticamente cuando finaliza una grabación con temporizador, incluso aunque la grabación comenzase con la grabadora encendida.

## Copiado (CINTA ↔ DVD)

# Copiado de una cinta VHS a un DVD

+RW -RWVR -RWVideo +R -RVR -RVideo  
VHS

Puede grabar (copiar) fácilmente una cinta VHS en un disco. Antes de hacerlo, realice los ajustes de audio necesarios en la videograbadora.

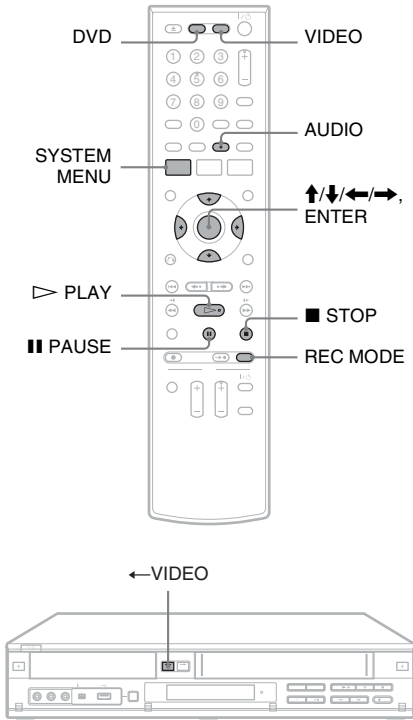

**1 Presione DVD e inserte un disco grabable.**  
Para seleccionar el modo de grabación, presione REC MODE varias veces (consulte la página 17).

**2 Inserte una cinta VHS de origen.**

**3 Presione VIDEO para utilizar la videograbadora.**

**4 Inicie la reproducción de la cinta VHS y, a continuación, presione ■ STOP o ■ PAUSE en el punto en el que desee iniciar el proceso de copiado.**

Para seleccionar el sonido de la videograbadora, presione AUDIO durante la reproducción.

**5 Presione ← VIDEO en la grabadora.**  
Comienza el copiado.

## Para detener el copiado

Presione ■ STOP.

Tenga en cuenta que la grabadora demora algunos segundos en detener el copiado.

## Para copiar mediante el menú en pantalla

**1** Después de realizar el paso 4 descrito anteriormente, presione SYSTEM MENU.

**2** Seleccione "Copiado" del menú del sistema y presione ENTER.

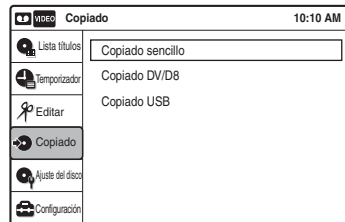

**3** Seleccione "Copiado sencillo" y presione ENTER.

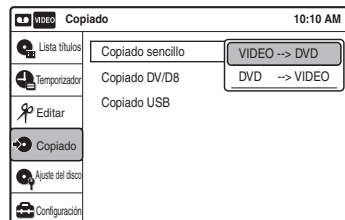

- 4 Seleccione “VIDEO → DVD” y presione ENTER.  
La pantalla solicita confirmación.
- 5 Seleccione “Sf” y presione ENTER.  
Comienza el copiado.

### 🔧 Observaciones

- Si aparece una pantalla negra (sin señal) al final del disco copiado, no se trata de un mal funcionamiento. Esta pantalla se graba si existen diferencias entre el tiempo del disco y de la cinta al detener la grabación.
- En el proceso de copiado de una cinta VHS a un DVD, es posible que la lectura del contador de la cinta VHS difiera ligeramente del tiempo de grabación del DVD.
- Durante el copiado, se emite el sonido de reproducción de la videgrabadora.

### Notas

- El copiado no podrá realizarse si:
  - utiliza un DVD no grabable.
  - utiliza un software VHS con funciones de protección contra copia.
- El copiado se detiene cuando:
  - la cinta VHS alcanza el final y se detiene.
  - la pletina de video VHS o la pletina de DVD se detiene.
  - se agota el tiempo restante del disco.
- El menú del sistema, el menú OPTIONS y la pantalla de información no se muestran durante el proceso de copiado.
- Derechos de autor
  - Las grabaciones realizadas de cintas VHS y otros materiales con derechos de autor son únicamente para disfrute individual, y cualquier otro uso no autorizado está prohibido por las leyes de los derechos de autor.
  - La edición no autorizada de material protegido por los derechos de autor está prohibida por las leyes de los derechos de autor.

## Copiado de un DVD a una cinta VHS



Es posible grabar (copiar) un título de DVD a una cinta VHS. Tenga en cuenta que cuando graba software protegido contra copias a una cinta, es posible que la imagen aparezca desestabilizada al reproducir la cinta.

Antes de realizar el copiado, efectúe los ajustes de audio necesarios en la grabadora de DVD.

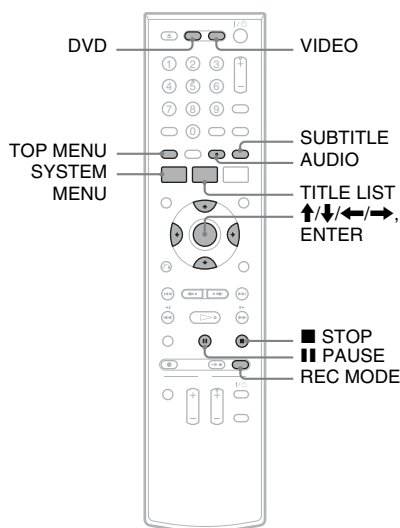

Copiado (CINTA ↔ DVD)

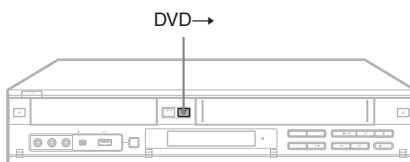

- 1 **Presione VIDEO e inserte una cinta VHS con la lengüeta de seguridad colocada en su sitio.**

Para seleccionar el modo de grabación, SP o EP, presione REC MODE varias veces (consulte la página 24).

- 2** Inserte un disco de origen.
- 3** Presione DVD para utilizar la grabadora de DVD.
- 4** Presione TOP MENU o TITLE LIST para seleccionar un título.
- 5** Inicie la reproducción del DVD y, a continuación, presione ■ STOP o ■ PAUSE en el punto en el que desee iniciar el proceso de copiado.  
Para seleccionar el sonido, idioma o los subtítulos del DVD, presione AUDIO o SUBTÍTULO durante la reproducción (consulte la página 14).
- 6** Presione DVD → en la grabadora.  
Comienza el copiado.

- 4** Seleccione “DVD → VIDEO” y presione ENTER.  
La pantalla solicita confirmación.
- 5** Seleccione “Sí” y presione ENTER.  
Comienza el copiado.  
Si aparece el menú del disco al finalizar la reproducción del DVD, presione ■ STOP para detener el proceso de copiado ya que, de lo contrario, el menú del disco quedará grabado hasta que la cinta llegue al final.

### Para detener el copiado

Presione ■ STOP.

Tenga en cuenta que la grabadora demora algunos segundos en detener el copiado.

### Para copiar mediante el menú en pantalla

- 1** Después de realizar el paso 5 descrito anteriormente, presione SYSTEM MENU.
- 2** Seleccione “Copiado” del menú del sistema y presione ENTER.

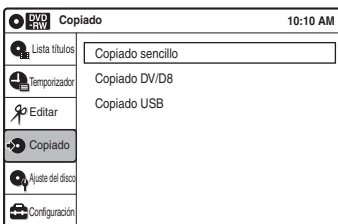

- 3** Seleccione “Copiado sencillo” y presione ENTER.

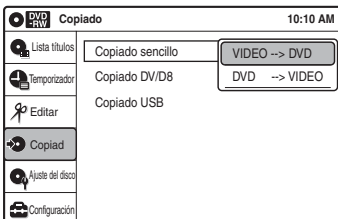

### Observaciones

- Es posible que el brillo de la imagen de reproducción varíe del de la reproducción de DVD normal.
- Es posible que el tiempo de reproducción del DVD difiera ligeramente de la lectura del contador de la cinta VHS.
- El sonido que se reproduce (principal, secundario, etc.) es el sonido copiado.

### Notas

- El copiado se detiene cuando:
  - el DVD se reproduce hasta el final y se detiene.
  - la pletina de video VHS o la pletina de DVD se detiene.
  - se agota el tiempo restante de la cinta.
- El menú del sistema, el menú OPTIONS y la pantalla de información no se muestran durante el proceso de copiado.
- Derechos de autor
  - Las grabaciones realizadas de discos y otros materiales con derechos de autor son únicamente para disfrute individual, y cualquier otro uso no autorizado está prohibido por las leyes de los derechos de autor.
  - La edición no autorizada de material protegido por los derechos de autor está prohibida por las leyes de los derechos de autor.







