

Warnings

The Lowel Pro-light is a professional lighting fixture. Read these instructions and lamp manufacturer's warnings before operating.

- **Not for house hold use, use only** for film, video or imaging purposes.
- **Do not leave fixtures unattended.**
- **Unplug fixtures when not in use.**
- **The units use lamps of several** different voltages. Make certain that lamp voltage matches power source voltage. *Example: never connect a 120 volt lamp to a 220 volt source.*
- **Units such as this emit** considerable light and heat, and if not properly used, could be dangerous.
- **Lights should not be positioned** extremely close to people. Ultraviolet light ray emissions can cause damage to the eyes and reddening of the skin. The likelihood of either occurring is increased with length of exposure, focus intensity and proximity. Therefore, lights should be kept away from people.
- **Avoid aiming the light at, or placing** too close to, people, delicate objects or flammable materials.
- **Do not interfere with ventilation** by covering the lights in any way.
- **For proper ventilation, do not tilt** down beyond 45 degrees or operate sideways.
- **Do not operate Pro-lights upside-down** with lamps of more than 125 watts.

Yes

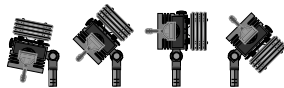

No

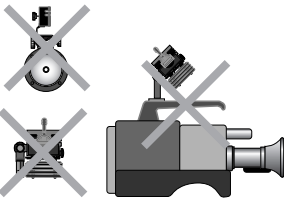

- **Do not tilt Pro-light down** if mounted on top of a camera. Camera damage could result.
- **Never touch hot parts only touch** handles & knobs for light adjustments.
- **Do not touch Pro-light upper front** end knob while operating the light, high temperature is present.
- **Do not use near standing water.**
- **Avoid mounting lights directly over** people unless secured with a safety cord or cable.
- **The updated Pro-light (2003) has** an IEC connector for its integrated AC Cable. However older Pro-lights use a 3 pin Edison fixed power cable which is to be used only with the Pro-light and not as a general-purpose extension cable.
- **Keep Pro-light power cable away** from front housing when hot, to avoid damage.
- **If battery power is used, never store** the light without first removing the power cable from the power source.

Pro-light Technical Data

Weight:
Pro w/ 4' captive cable:
 1.3 lbs (590 g)
Pro w/ 4' cable & 12' extension cable: 2 lbs (907 g)
Max. wattage: 250
Max. amperage: 8.3
Beam control: continuously variable
Fits on: 5/8" (1.59 cm) studs
Materials: primarily aluminum and Ryton
Cable: with extension 16' (4.88 m) #18/3. CE model with #18/2.
Switch: in-head
U.S. Patent: 4777566

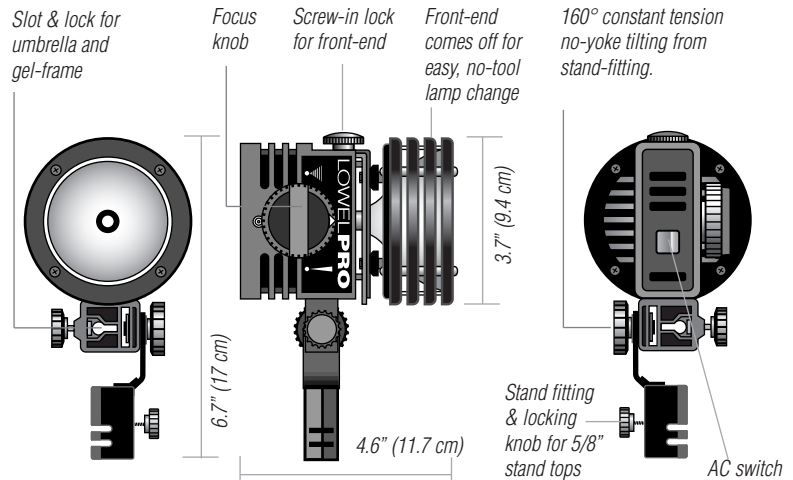

Lamp/Beam Data (Pro & i/d lamps are not interchangeable)

Lamp Code	Volts	Watts	°K	Avg Life	Flood	Spot	F. C. (lux) at 10' (3 m)	Super Spot
FVL*	120	200	3200	100 hr	23 (250)	143 (1540)	6:1	302 (3260)
FSH	120	125	3200	100 hr	11 (115)	48 (515)	4.5:1	139 (1500)
GCC	12	100	3200	100 hr	12 (125)	58 (630)	5:1	245 (2650)
JCV14.5V-50WC								
	12/14	50	3200	100 hr	6 (70)	28 (305)	4:1	125 (1350)
GLF/P44 **	230	235	3200	100 hr	39 (420)	81 (880)	2:1	178 (1920)

* Replaces GCA as recommended lamp

** Only fits CE Pro-light, updated Pro-light (4/2003) & older Pro-lights with updated Front Housing (iP2-18)

Performance

With 120v, 200w, 3200°K, Osram FVL lamp

Foot Candles (Lux = foot candles x 10.8)

Flood	23	11	7	4
Spot	552	143	61	34
Super Spot	1139	302	135	80

with Clear Safety Glass

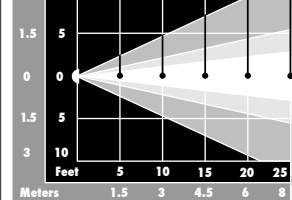

Power Cables & Connectors

12' AC Unswitched Cable

Code: P2-80

#18/3 cable with IEC connector is supplied with the Pro-light to extend its captive cable.

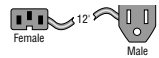

Code: P1-80 Original AC cable for pre-updated Pro-lights (pre-April 2003).



Optional Power Cables

To connect to international voltage or popular battery power sources, the following adaptor cables are available from Lowel for updated (IEC) Pro-lights (contact us for older models).

AC options

P2-801 12' Pro Euro cable (IEC)

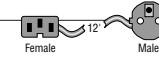

P2-802 12" Pro UK cable (IEC)

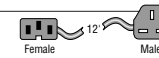

12 Volt battery

P2-82 1' 4-pin XLR Cable



P2-85 1' 12v Cigarette



Lighter/CarAdaptor Cable

30 Volt battery

P2-81 1' 2-pin switched 30v Cable



Pro Lamp Replacement

Warning: Always unplug unit before relamping. Fixture must be cool before relamping. Lamps must be operated at their rated voltage. Avoid touching "glass" with bare fingers. Insert lamp carefully, to avoid breaking.

To change lamps

- 1 Turn focusing knob **A** to spot position.
- 2 Unscrew the small knob **B** located on top of the front housing. Remove front assembly.
- 3 Grasp porcelain socket of lamp **C** and rock lamp gently from side to side while pulling straight out from fixture socket.
- 4 To replace lamp, hold focusing knob in spot position and insert lamp into socket. **Warning:** Avoid touching the glass of the lamp with bare fingers. Make sure lamp is well seated in the socket. Improper insertion could result in arcing, which will shorten lamp and socket life.
- 5 Replace the front housing and tighten the top knob. **Warning:** Compact filament lamps such as the GCA may fail if subject to vibration or shock while on. Turning the fixture off before moving or adjusting as well as operating the focus smoothly will help prevent lamp failure.

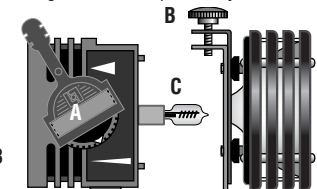

Lowel Pro-light Instructions

Pro Light Controls

Pro-lights are supplied with the iP #2 Reflector

This faceted high intensity reflector can be used with either the supplied Prismatic Glass for standard focusing. Swap to Clear Safety Glass for high intensity non-focusing super-spot only.

Never operate Pro or i-lights without glass in front housing.

Changing Pro Front Housing Glass

(Prismatic [iP-52] or Clear Safety [iP-49])

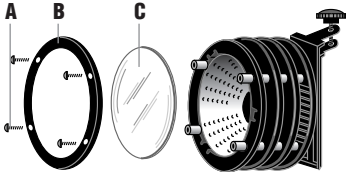

- 1 Remove the four screws **A** located on the front of the light and lift off the cover plate **B**, and the Prismatic Glass **C**
- 2 Replace the Prismatic Glass with Clear Safety Glass. Reassemble in reverse.

Another option is to purchase the #2 Reflector with Front Housing & Safety Glass Code: iP2-19

Pro & i Focusing and Focus Knob Extension

Code: iP-35

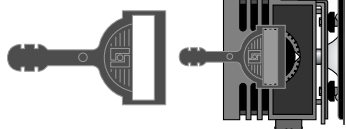

Turning focusing knob, located on the side of the housing, alters the beam of light from flood to spot. A focus knob extension accessory snaps into focus knob for left-hand or on-camera focusing.

Note: Compact filament lamps such as the GCA may fail if subjected to shock or vibration while on. Operating the focus smoothly will help prevent lamp failure.

Attaching gel frames & umbrellas

Pro-lights have a Universal Mounting Bracket (UMB) **A** located below the fixtures adjacent to the stand fitting **B**. It accepts the Tota-brella or Pro & i Gel frame.

Note: the bracket can only accept one accessory at a time.

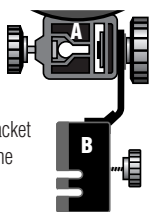

Pro-light & i-light Barndoors

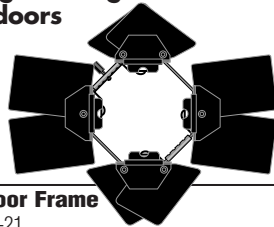

Barndoor Frame

Code: iP-21

Accepts swing-in accessories, and/or leaves. Rotates 360°.

Attaching the Barndoor Frame

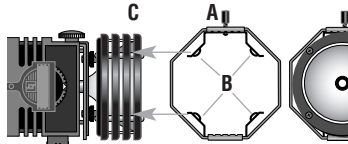

to the front of the light with and without barndoors.

- 1 Loosen the knob **A** on the Barndoor Frame.
- 2 Set the frame clamp retaining feet **B** into the first ventilation groove **C** of the light.
- 3 Tighten knob. Proper installation allows full 360-degree rotation of the complete barndoor assembly.

Attaching the leaves to the Barndoor

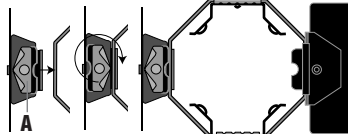

Expandable Leaves and Non-expandable barndoors are attached to the frame by constant-tension lock fasteners **A** located on the rear of the doors. The lock fasteners require a 1/2 (180-degree) turn to remove or install the barndoors. Lock fasteners should be on the "inside" of the barndoor flap. It is possible to install a barndoor leaf backwards so that it will not close over the light. It is important to align the barndoor leaf to the frame.

2-way Barndoor

Code: iP-25

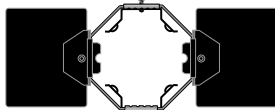

Barndoor Frame with two removable non-expandable leaves. Frame accepts swing-in accessories and additional leaves. Rotates 360°.

Expandable

Rectangular Leaf

Code: iP-22

Changes from small to large rectangle.



Expandable Triangular Leaf

Code: iP-23

Changes from triangular to square shape.



Non-expandable Clip-on leaf

Code: iP-24

Rectangular leaf. Can be attached to, or removed from, Barndoor Frame.

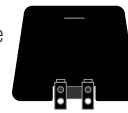

Gel-Jawz Code: CL-15

Attach to barndoor leaves to hold gels. Use two per light.

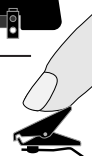

Swing-in Accessory Holder Code: iP-30

Holds Light Control Accessories, attaches to the Barndoor Frame in a similar manner as the barndoor leaf. Align Accessory Holder on Barndoor Frame. The lock fastener requires a 1/2 (180-degree) turn to remove or install the Accessory Holder. When in use, Accessory Holder swings over the light and locks onto the other side of the frame. Three holders can be attached to the Barndoor Frame simultaneously, but only one can be used at a time. A full barndoor set and a single holder can be used at once. Quickly swinging one holder out of position and swinging in another is a valuable user convenience.

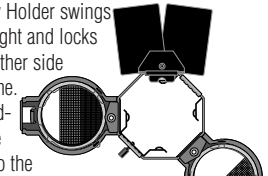

Changing Light Control Accessories

Simply release the captive retaining spring clip

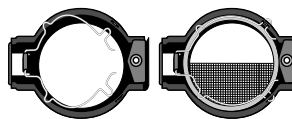

located inside the Holder and remove accessory. Insert new accessory and secure retaining spring clip. A scrim and glass accessory may be mounted together in a single Accessory Holder.

Note: Separate holders for each accessory are recommended for fast in-use changes.

Swing-in Accessories



Diffused Glass Code: iP-50

Softens highlights and shadows. Absorbs U.V. light rays Light loss approximately 40%, at Flood.



iP Prismatic Glass

Code: iP-52

Supplied with all Pro-lights. Gives an evenly dispersed flood, produces a uniform spot and a fresnel-like barndoor cut. When used in holder with Clear Safety Glass installed in front housing, allows focusing use when swung in & super spot use when swung out.



Dichroic Filter Code: iP-51

Converts 3200 K lamps to average daylight; absorbs U.V. light rays Light loss approximately 65%.



Full Scrim Code: iP-54

Reduces light by approximately one stop.



Half Scrim Code: iP-55

Covers half of reflector and rotates 360° darkens washed out foregrounds, compensates for actors "burning up" as they approach a light.



Graduated Scrim

Code: iP-56

Same principle as half scrim but effect is more gradual and more extreme.

iP Snoot



Code: iP-53

Produces a reduced circle of light. A Snoot attaches to the light in the same manner as a Barndoor Frame. Barndoors and barndoor accessories may also be added to the end of the Snoot.

Pro & i Gel Frame

Code: iP-40

Holds 5 x 6" gels. Unfold frame, extending frame bar and insert through front slot of UMB Lock with knob. Pans and tilts with the light, collapses for storage.

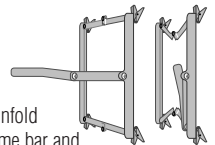

Pro & i Gels

Size: 5 x 6" (12.52 x 15.25 cm) sheets

Tota-brellas



Photographic umbrellas convert relatively hard light sources, such as spotlights, into relatively soft sources that provide soft shadows and highlights. Although not appropriate for every subject or mood, the quality of light can be very beautiful. There are two umbrellas designed for use with the Pro-lights:

Silver Code: T1-25, reflective umbrella.

White Code: T1-26, a white nylon umbrella that produces a softer light and also may be used as a large diffuser.

To Mount Umbrella insert umbrella shaft through round hole in UMB and lock with knob. Tota-brella and gel frame cannot be used simultaneously.

Warning - When lights with umbrellas are extended very high, or used on undersized stands or in areas of heavy "traffic", it is advisable to add weight (such as the Lowel weight) to the base of the stand to reduce the chance of lights falling over which could damage the umbrella, the lamp and possibly cause personal injury.

Warning - To prevent possible umbrella damage, avoid full or near-full spot reflector settings on the Pro or i-light and do not use with a Clear Glass as Super-spot.

Pro-light Mounts

Stands

The Pro-light will lock onto stands with top studs up to 5/8" (16mm). We recommend the Uni-stand or Uni TO Stand, for most applications. Where elevation greater than 7' 11" is required, we recommend Lowel KS or KS Jr. stands. Pro-lights can be positioned low on any stand with a Tota-clamp. Lowel-weights add to stand stability and should be used when appropriate.

Uni-stand

Code: UN-33
Size: 21.5" (54.6 cm) folded.
 Extends to 7'11"
 All aluminum stand, wide base, legs can lie flat to floor, large locking knobs. Folds compactly to fit in smaller kits.

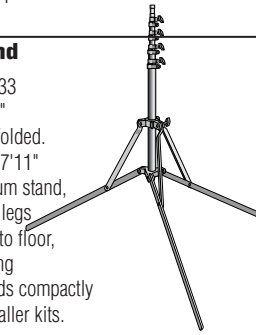

Uni TO Stand

Code: UN-55
Size: 21.5" (54.6 cm) folded.
Maximum height: 7'11" (2.4 m)
Base diameter: 43"
 New stand, based on design combination of Uni-stand & Omni-stand. More stable than Uni-stand, more compact than Omni Stand.

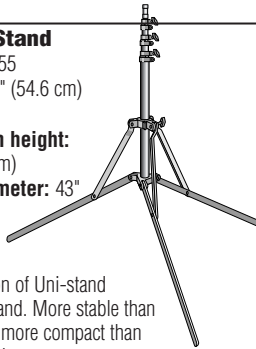

Vipod & Stud-link

Code: ViP-35S
 Supports Pro and other ViP lights on flat surfaces. Vipod can be screwed, Gaffer-taped or clamped to vertical surfaces. Stud-link is removable. The Low Link can also be mounted on the Vipod by attaching the Low link to the Vipod using the knob provided with the Lowel link.

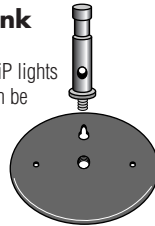

Tota-mount

Code: T1-32
 Tota-mount supports any of the ViP fixtures atop doors and partitions. Doors can be open or closed. The light can be inside or outside room, since swinging arm extends past most door jams. Tota-mount can be flipped over and nailed to studio set walls or Gaffer-taped to windows or tile, wood, metal and other wall surfaces.

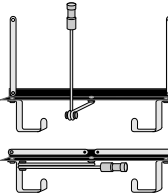

Mounting Tota-mount & Vipod with Gaffer Tape

Use 12" of Gaffer-tape on each bar on Tota Mount or side of Vipod and burnish down with a coin. Avoid



wallpaper, soft composition board or flaking paint. Never attach to the ceiling with tape. Use original Lowel Gaffer-tape. Many substitutes leave adhesive residue or lack sufficient strength. When properly attached, Tota-mount or Vipod will support the light for days. However, on dirty or poorly bonded surfaces, or with improper or poorly applied tape, there is the danger of the mount falling down and causing serious damage. Check adhesion periodically. Prevent direct light from overheating tape. Remove tape when cool, by peeling back diagonally. Tota-mount should not be used with lights heavier than 3 lbs. (1.33 kg)

Tota-clamp

Code: T1-30
 Tota-clamp supports most lights that fit standard 5/8" studs. Tota-clamp can be attached to pipes, stands, or flat surfaces. When clamping on furniture, use thin wood or cardboard to avoid marring. To rotate stud, turn wing nut counterclockwise several turns. The stud can be locked in any of four positions; two for the 5/8" stud and two for the end with the 1/4-20 tapped hole. A 1/4-20 screw can be used to lock on some microphone yokes and various accessories. Tota-clamp has two snap-in fittings for Flexi-shafts.

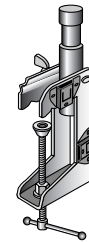

Scissor Mount

Code: CM-20
 Attaches i-lights, and V-lights to dropped ceiling: Clamp X bars of grid lock to T-Bar of ceiling. Attach fixture to mount stud and tighten. Pro lights should use the Grid Lock for dropped ceiling mounting. Avoid mounting fixtures directly over people unless secured with a safety cord or cable.

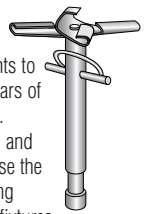

Grid Lock

Code: CM-21
 Attaches Pro-lights to dropped ceiling: Clamp X bars of grid lock to T-Bar of ceiling. Attach L-link to clamp using large knob. Remove stand fitting from fixture by removing large knob located on the standfitting. Attach fixture to L-link using the same large knob that hold standfitting in place. Pro light must be operated with the "top" of the light towards the ceiling. Avoid mounting fixtures directly over people unless secured with a safety cord or cable.

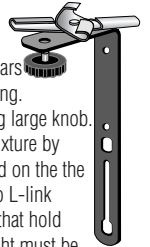

For additional information on products such as Space-clamp, Lobo & Lobo Arm, consult product instruction sheets, relevant sections in the Lowel Catalog or visit the Stands & Mounts section of www.lowel.com:

Professional Camera & Handheld Mount Options

Caution: Camera damage may result if light is pointed down while lamp is on.

L-link

Code: ViP-36
 Can be used to extend Pro or i-lights from Cam-links and Vipods. To use, mount short leg of L-link on to Cam-link or Vipod using the knob provided. Remove Stand-link from fixture by loosening the large knob, attach light to upper part of slot with the large knob.



Low-link

Code: ViP-37
 Enables Pro and i-light to be mounted on Cam-links and Vipods.

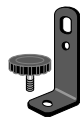

Stud-link

Code: ViP-38
 5/8" (16mm) stud with 1/4-20 male screw, used to mount fixtures with Stand-link to cameras with proper female socket.



Cam-link

Code: ViP-41
 Male "shoe" fitting locks into cameras with proper female shoe mount. Accepts Stud-link Low-link or L-link.



Cam & Stud-link

Code: ViP-41S
 For mounting fixtures with Stand-link on cameras with proper female shoe mount. Slide Cam-link onto camera shoe, screw Stud-link into top of Cam-link to tighten. Do not over tighten! Mount light on stud and secure by tightening Stand-link lock knob.

Cam & Low-link

Code: ViP-41L
 For mounting fixtures directly on cameras with proper female shoe mount. Remove Stand-link from fixture by undoing the large attaching knob located on the side of the fixture. Attach low link using the upper hole and with the "leg" facing "under" with the large knob. Mount the Fixture/ Low-link assembly to the Cam-link, using the knob provided. Slide the Cam-link/light assembly onto camera shoe, secure by tightening knob on Cam-link. Do not over tighten!



Handle & Stud

Code: ViP-431
Weight: 3 oz (85 g)
 For hand holding ViP lights. Updated Handle with 1/4-20 screw-threaded post, and 5/8" Stud with 1/4-20 screw-thread hole in bottom. Without Stud, Handle accepts screw-thread at bottom of UMB on ViP Lights. With Stud, can accept ViP or other small lights with 5/8" stand-fitting.



Replaces ViP-43 Handle & Stud-link

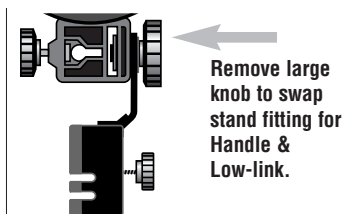

Remove large knob to swap stand fitting for Handle & Low-link.

Problems, Info, etc.

Repairs, problems, suggestions, and requests for brochures/catalogs, instructions, and parts lists may be handled by your Authorized Lowel Dealer/ Distributor or directly through Lowel. Electrical repairs and cable modifications should be made only by Lowel or a qualified electrician. Lowel ViP System, Lowel V-light, Lowel i-light, and Lowel Pro-light are trademarks of Lowel-Light Manufacturing, Inc. Patent Nos. 4777566, 4322779, 0011772 (Europe), 1292007 (Japan).



Lowel Pro-light Instructions

Pro-light for the New Professional

Use the Pro-light as a flexible key, fill or back-light. Adding accessories will extend its creative possibilities.

Use the focusing knob **A** to move from Spot **C** (narrow beam) to Flood **B** (wide beam). Its 5:1 focus ratio (when used with a GCA lamp) means that the spot setting will be approximately 5 times as bright as the flood setting.

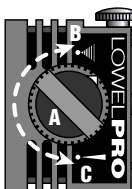

The Pro-light has a high intensity reflector & prismatic glass installed. This gives an even output with a fresnel like quality in the shadows, an evenly dispersed flood, and a uniform spot with significant barndoor cut.

It is capable of throwing sharper shadows when used on its own. Add a diffusion glass swing-in accessory, diffusion gel with a gel-frame, or attach an umbrella to create a softer source. Use one Pro without diffusion and another with diffusion, to create the classic "hard key & soft fill" lighting setup common in many interview & still life settings.

Use the 360° rotating barndoors to trim unwanted output spill, (for example: to reduce risk of shadow in your shot caused by use of overhead boom microphones).

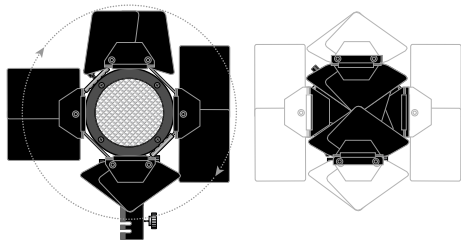

The Pro-light is a tungsten-halogen source, with a color temperature in the 3000–3200°K range, depending on lamp choice. To use Pro in locations where its output will mix with daylight (5600–6500°K), its color temperature can be converted by attaching a Dichroic Filter accessory, or adding day blue gels to the Pro & i gel-frame. Both will give more realistic daylight white-balancing in video or film.

To simply raise the ambient level of light in a room, point the Pro-light at a white wall or ceiling (from a safe distance of several feet or more), and focus to flood setting. Position the light so it won't be in your shot.

The Pro-light can use 125 or 250W lamps @ 120V. This can be useful to remember, especially when mixing with other fixtures of different max. wattages. See the lamp chart for more information.

For special use applications, Pro-light can be converted in the following ways:

Swap the power cord & lamp, for a battery powered, hand-held light at 12 or 30V.

Swap the Prismatic Glass to Clear Safety Glass for non-focusing higher output Super-Spot. This can be useful when lighting a small area from a greater distance when higher output is needed.

For more reduced spill, consider adding a Snoot.

Other front accessories can help vary the quality of the light output. For example, the rotating half-scrim can allow you to reduce light output on a close subject while still

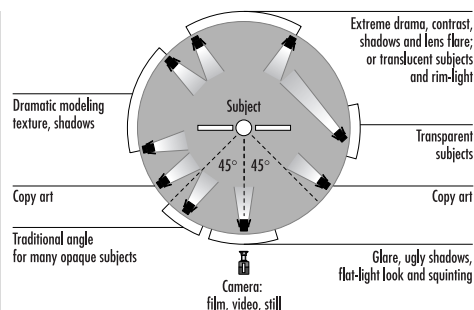

illuminating subjects further away with full output. The full scrim reduces output without the use of a dimmer which can shift the color temperature warmer as the lamp is dimmed.

The oversimplified diagram above shows some of the ramifications of positioning lights for different subject types & lighting effects. This diagram is only useful as a starting point for new pros. All subjects & scenes are different and make different demands upon lighting. The height of the lights & camera, and the subjects angles & reflectivity must be considered.

When finished setting multiple lights, it's a good idea to check the effect of each light by powering them all down & looking at your set with one light on at a time. This will help you better understand the components of lighting and how each fixture contributes to the final image.

These are just some starting suggestions. For additional introductory information, see the Resources section of the complete Lowel catalog. For an in-depth understanding of the creative decisions involved in the art of lighting, we suggest Ross Lowel's acclaimed book, *Matters of Light & Depth*, available from many of our dealers.

Example Setups using Pro-light

These 3 setups show some ways the Pro-light can be used; alone, with Tota-brella, or with diffusion, in a small lighting setup. Position of the lights and distance to the subject can be varied for different creative results. Varying the distance of either light from the subject will vary the contrast ratio between Key & Fill lights. **Tip:** position your subject away from walls to avoid shadows and give more sense of depth.

Setup Keys

- A** Key light Pro with barndoors
- B** Fill light Pro with umbrella
- C** Background Tota or V-light
- D** High back light Pro with gel-frame & diffusion

Setup 1

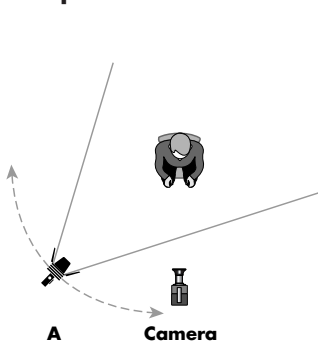

Setup #1 shows single fixture use, and can be set on either side of the camera. Varying the position of the light will increase shadow & contrast on the subject.

Setup 2

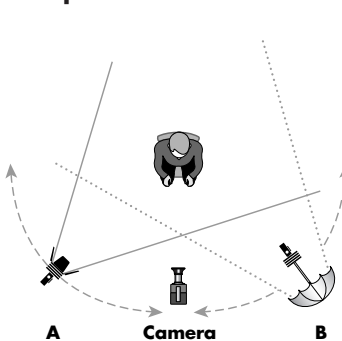

Setup #2 uses 2 Pro's, one with only barn doors, as hard key, and the other with a Tota-brella as soft fill. Vary the position of the lights, as shown. Be aware of reflection in eyeglasses or reflective surfaces.

Setup 3

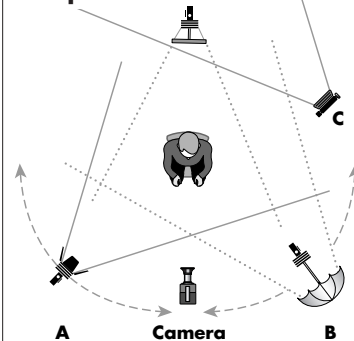

Setup #3 uses 2 Pro's as hard key/soft fill, with a Tota or V-light to evenly light the background. An additional Pro from high up behind the subject as a back hair-light, lighting the back of the head & shoulders, will create a sense of separation from the background. Be careful to keep the light output of the back light from spilling into the camera lens which will cause lens flare.

Lowel-Light Manufacturing, Inc.



90 Oser Avenue, Hauppauge, N.Y., 11788
Call: 800 645 2522
Fax: 631 273 2557
e-mail: info@lowel.com
www.lowel.com



Ver. 2.6 © 2010 Lowel-Light Mfg, Inc. 920