

* Image shown may differ from your TV.
 * Image shown on a PC or mobile phone may vary depending on the OS(Operating System).

Wireless Network Connection

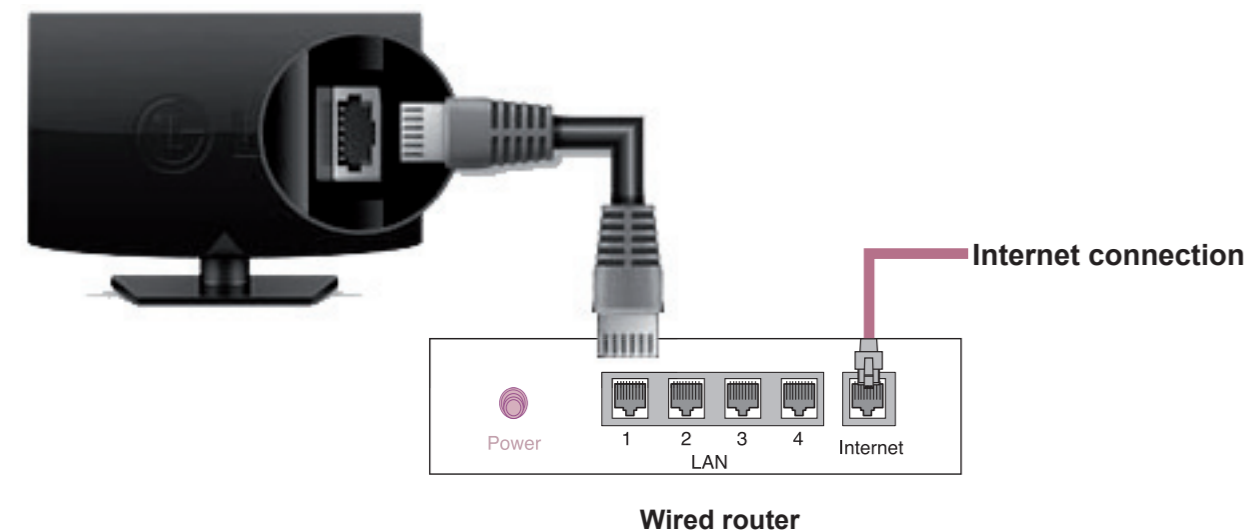

Wired Network Connection



Network Setting

Premium Apps are pre-installed on the TV. These may vary by country.

- 1 Press the **SMART** button to access the Smart Home menu. Select **Settings** and press **Wheel(OK)**.

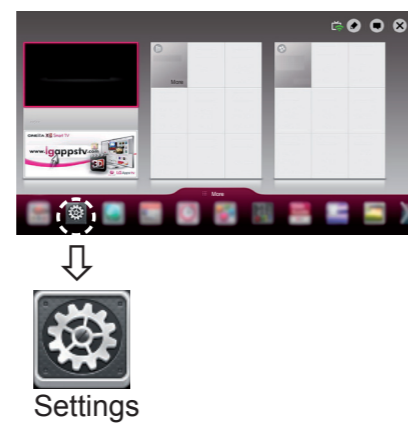

- 2 Select the **NETWORK** → **Network Connection** menu.

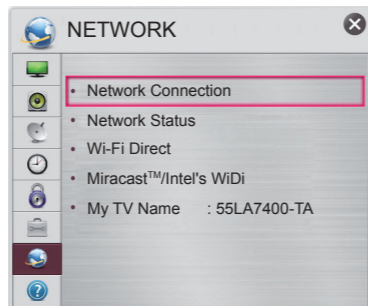

- 3 Select the **Start Connection**.

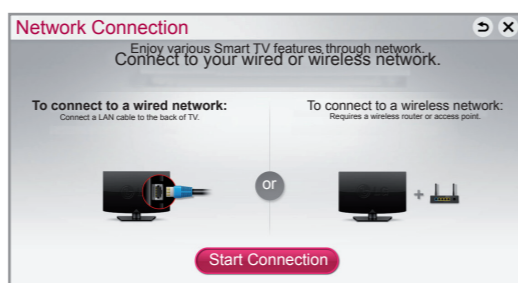

- 4 The device automatically tries to connect to the network available(wired network first).

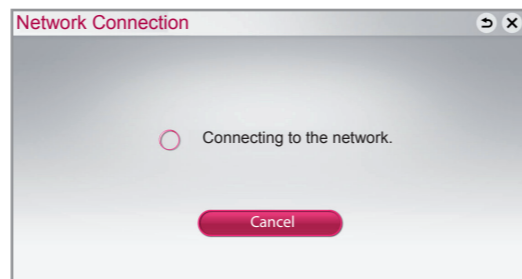

If you select **Cancel** or it fails to connect to the network, the network list available is displayed. Choose the network you want.

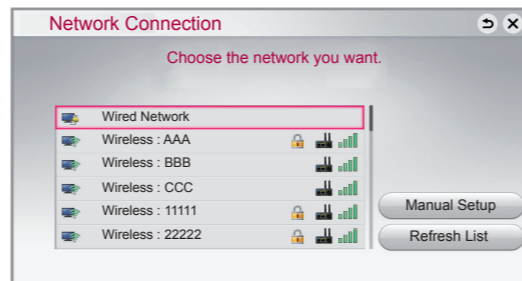

If you want to connect your TV to a wireless router, select the network you want and enter the password.

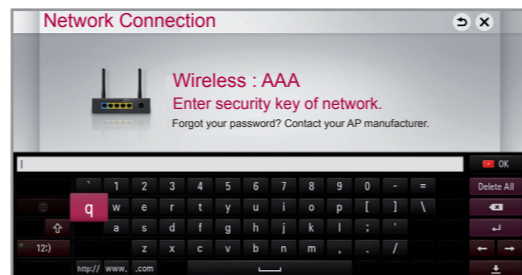

- 5 The connected network is displayed. Select **Complete** to confirm the network connection. If you select the **Other Network List**, the network list available is displayed.

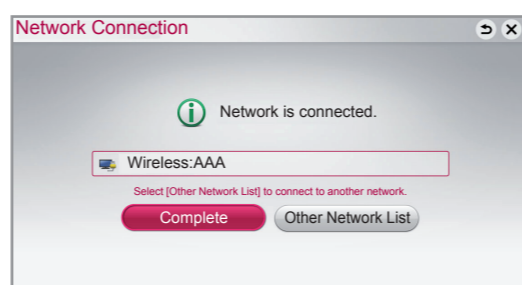

Troubleshooting Network Problems

- 1 Press the **SMART** button to access the Smart Home menu. Select **Settings** and press **Wheel(OK)**.

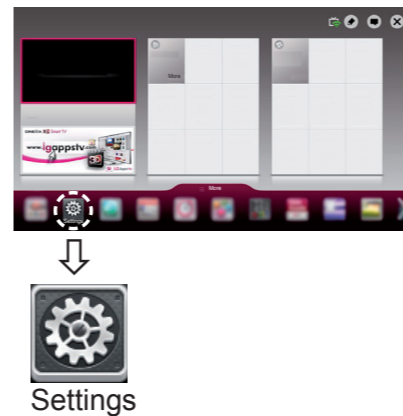

- 2 Select the **NETWORK** → **Network Status** menu.



Follow the instructions below that correlate to your network status.

Check the TV or the router.

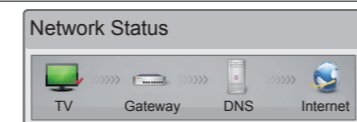

When an **✓** appears **TV**.

- 1 Check the connection status of TV, AP and cable modem.
- 2 Power off and power on TV, AP and cable modem.
- 3 If you are using a static IP, enter IP directly.
- 4 Contact internet companies or AP companies.
 - Additional points to check when using a wireless connection
 - 1 Check the password for the wireless connection in the router settings window.
 - 2 Change the router SSID (network name) or the wireless channel.

Check the router or consult your Internet service provider.

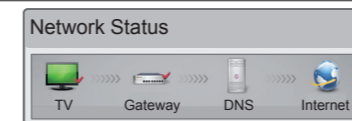

When an **✓** appears **TV and Gateway**.

- 1 Unplug the power cord of the AP, cable modem and try to connect after 5 seconds.
- 2 Initialize(Reset) the AP or cable modem.
- 3 Contact internet companies or AP companies.

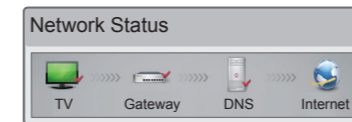

When an **✓** appears **TV, Gateway and DNS**.

- 1 Unplug the power cord of the AP, cable modem and try to connect after 5 seconds.
- 2 Initialize(Reset) the AP or cable modem.
- 3 Check that the MAC address of the TV/router is registered with your Internet service provider. (The MAC address displayed on the right pane of the network status window should be registered with your Internet service provider.)
- 4 Check the router manufacturer's website to make sure your router has the latest firmware version installed.

SmartShare PC SW Installing & Setting

Install the **SmartShare PC SW(DLNA)** and programme on your PC.

- 1 Go to www.lg.com. Then, select your region.
- 2 Select **SUPPORT**. Then, Search for your model.
- 3 Select **Drivers & Software** or **SOFTWARE UPDATE**. Then, select **SmartShare PC SW(DLNA)**.
- 4 You can run the programme when installation is complete.

NOTE

- DLNA service is only available if TV and other devices are connected via a single router.

DLNA Connection to Smartphone

- 1 Check that Wi-Fi is enabled on your smartphone.
- 2 Install/run the app for sharing content on your smartphone (It's called SmartShare on LG phones).
- 3 Enable your smartphone to share content files with other devices.
- 4 Select the file type you want to play (movie, audio or photo).
- 5 Select a movie, music or photo file to play on the TV.
- 6 Add the selected file to the playlist.
- 7 Select a TV model name on which to play the files. (The TV model name is labelled on the rear side of the panel.)
- 8 Play the media file to view and enjoy it on your TV.

Updating the TV Firmware

SMART → Settings → SUPPORT → Software Update

Uses Software Update to check and obtain the latest version. If not updated, certain functions may not work properly. It is also possible to check manually for available updates.

Software Update	Set it to On . If an update is available, a prompt will appear to perform the update.
Automatic update mode	If an update is available, the update automatically starts without prompting.
Check Update Version	Checks the latest update version installed. When a new update is available, the download process can be performed manually.

NOTE

- When the update starts, the update progress window appears for a short time and disappears.
- The latest version can be obtained via the digital broadcast signal or an internet connection.
- Changing the programme while downloading the software via a digital broadcast signal interrupts the download process. Returning to the initial programme allows downloading to resume.
- If software is not updated, certain functions may not work properly.

Tag On

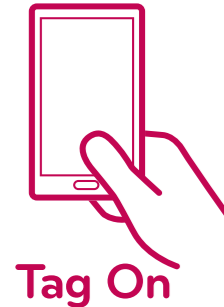

(This feature is not available for all model.)

Tag On is a data transmission technology that can be used on smartphones with NFC (Near Field Communication).

Simply by tapping your smartphone to a Tag On sticker, you can share content between your smartphone and TV.

To connect your smartphone to the TV using Tag On, they must be connected on the same Wi-Fi network or Miracast™/Intel's WiDi of the smart TV is set to On.

Wi-Fi Direct Setting

SMART → Settings → NETWORK → Wi-Fi Direct

The **Wi-Fi Direct** function supports wireless connection technology. With SmartShare™, you can share files or screens of devices connected to **Wi-Fi Direct**.

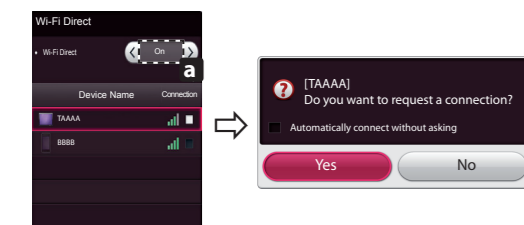

- 1 If **Wi-Fi Direct** is set to **On**, a list of available devices appears.
» To use **Wi-Fi Direct**, go to Settings → NETWORK and set **Wi-Fi Direct** (a) to **On**.
- 2 When you are prompted to request connection, select **Yes**. **Wi-Fi Direct** is now connected to your TV.

*If you are not using **Wi-Fi Direct** to minimize the interference between Wi-Fi devices, it is recommended to set **Wi-Fi Direct** (a) to **Off**. You can only use devices that support **Wi-Fi Direct**.

Miracast™ Setting

Miracast™ allows a portable device to securely send video and sound to TV wirelessly.

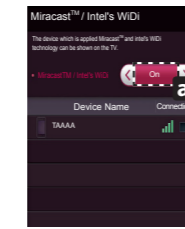

1. Miracast™ is set to **On** on your TV and portable device. Go to the Network settings to set the Miracast™.
2. When your portable device is detected, select the device.
3. For more information about how to connect the portable device, refer to the portable device manual.

WiDi (Wireless Display) Setting

WiDi represents Wireless Display. Intel's WiDi (Wireless Display) technology enables easy and fast connection without wires or internet network for mirrored and dual monitor display on your TV. You can sit back and experience your favorite movies, videos, photos, online shows and more in full HD on your TV with great image clarity and sound.

- 1 **Intel's WiDi** is set to **On**. Connect your laptop to AP. (Without AP, it is possible to this function; it is recommended to connect to AP.) Your laptop runs the Intel WiDi (b) programme.
- 2 It detects LG Smart TVs available, which supports WiDi. In the list, select the TV you want and click Connect. Enter the PIN number (a) shown on the screen into the input field (b) on your laptop and then click Continue.

NOTE

- When you connect the TV and laptop, you should set up TV mode for "Live TV" and "external input". If not, your computer cannot detect LG Smart TV.

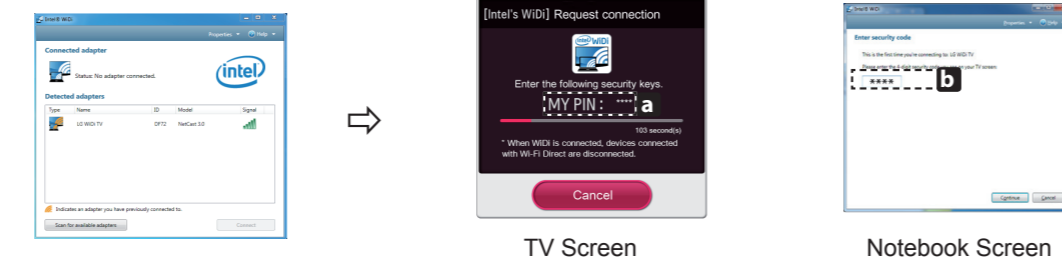

- 3 The wireless environment may affect the screen display. If the connection is poor, the Intel WiDi connection may be lost.

* LG TV is not need to register.

* For more information on Intel WiDi, visit <http://intel.com/go/widi>

* A list of **Intel's WiDi** devices does not appear on the TV screen. Please check the list on your laptop.

Time Machine II

Take Control of Time with Time Machine

With your external USB storage devices, Timeshift allows you to stop and rewind live TV, and record or set the timer for your favourite TV programmes.

* Time Machine II can record any programme in analogue and digital format, and can also record AV input. (Depending on model)

* Other services are also available while recording a TV programme.

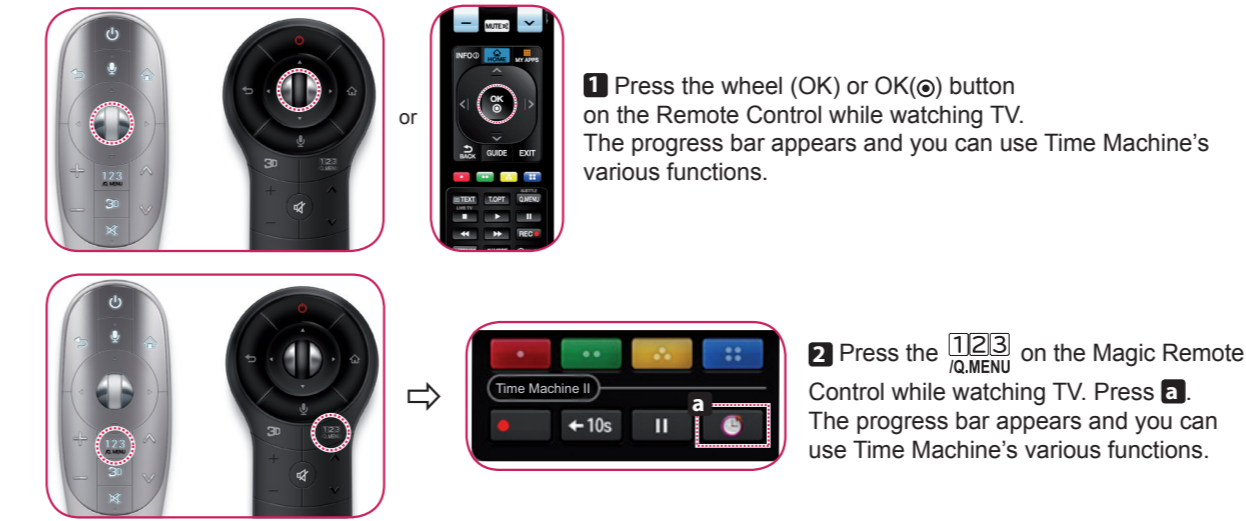

You can select and move the point you want to play.

You can return to a live TV programme when using the Timeshift function.

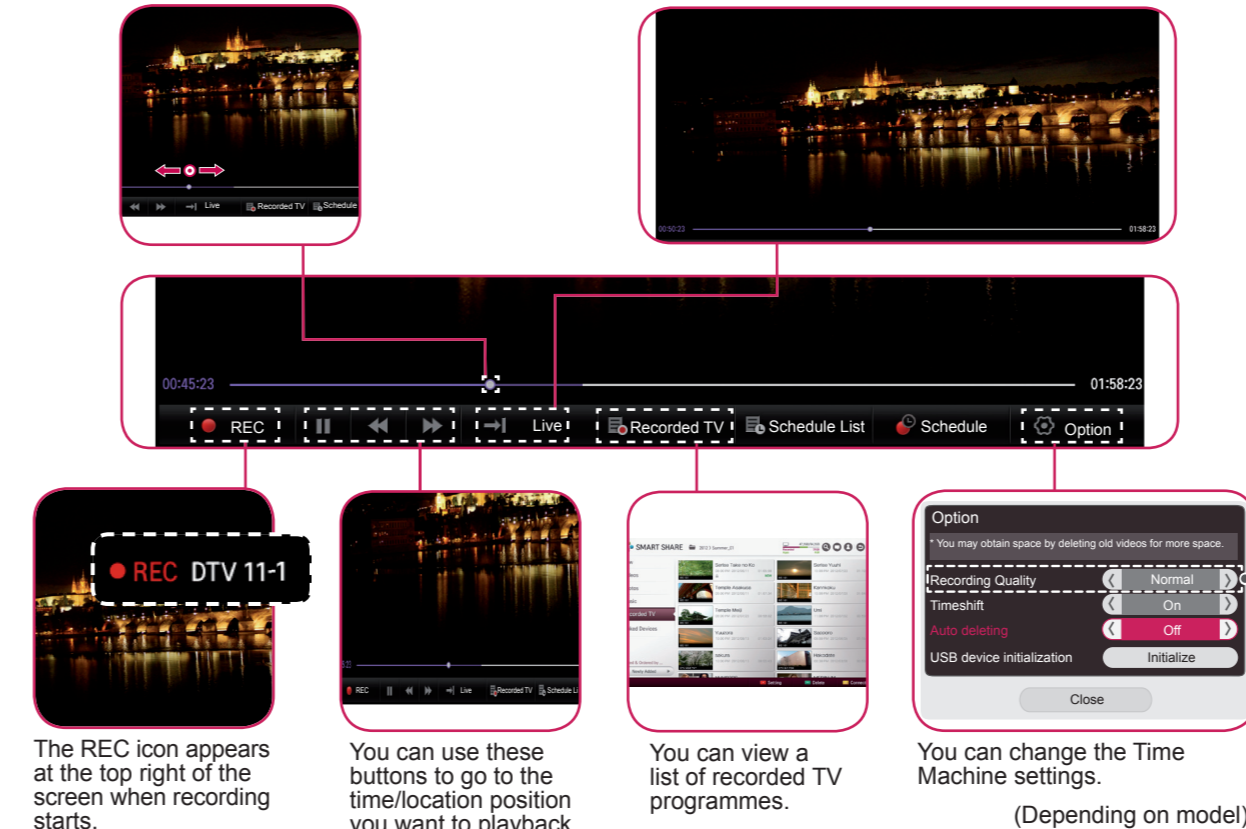

The REC icon appears at the top right of the screen when recording starts.

You can use these buttons to go to the time/location position you want to playback.

You can view a list of recorded TV programmes.

You can change the Time Machine settings. (Depending on model)