

1400 Series Professional UHF Wireless Systems

ATW-1451 UniPak™ Transmitter System

ATW-1452 Handheld Dynamic Microphone System

Installation and Operation



audio·technica®

Professional UHF Wireless Systems

Installation and Operation

This device complies with part 15 of the FCC Rules. Operation is subject to the condition that this device does not cause harmful interference.

This device complies with INDUSTRY CANADA R.S.S. 210, en conformité avec IC: RSS-210/CNR210. Operation is subject to the following conditions: 1) This device may not cause harmful interference and 2) this device must accept any interference received, including interference which may cause undesired operation.

CAUTION! Electrical shock can result from removal of the receiver cover. Refer servicing to qualified service personnel. No user-serviceable parts inside. Do not expose to rain or moisture.

The circuits inside the receiver and transmitter have been precisely adjusted for optimum performance and compliance with federal regulations. Do not attempt to open the receiver or transmitter. To do so will void the warranty, and may cause improper operation.

Individuals with implanted cardiac pacemakers or AICD devices: Please see notice on back cover.

Introduction

Thank you for choosing an Audio-Technica professional wireless system. You have joined thousands of other satisfied customers who have chosen our products because of their quality, performance and reliability. This Audio-Technica wireless microphone system is the successful result of years of design and manufacturing experience.

This professional wireless system includes a receiver and either a body-pack or a handheld transmitter on a specific crystal-controlled frequency.

The receiver features true diversity reception. Two antennas feed two completely independent RF sections on the same frequency; automatic logic circuitry continuously compares and selects the superior received signal, providing better sound quality and reducing the possibility of interference and dropouts. The receiver is half-width for a standard 19" (1U) rack mount. Two receivers (on different frequencies) can be mounted side by side, using an AT8628 joining plate kit.

The versatile UniPak™ body-pack transmitter has both low- and high-impedance inputs plus a bias connection, for use with dynamic and electret condenser microphones, as well as Hi-Z instrument pickups. Both the handheld and UniPak transmitters use internal 9-volt batteries and have Off/Standby/On switches, battery condition indicators, and battery-save switches.

Please note that in multiple-system applications there must be a transmitter-receiver combination on a *separate* frequency for each input desired (only one transmitter for each receiver). Operating frequency information will be found on page 7.

Receiver Installation

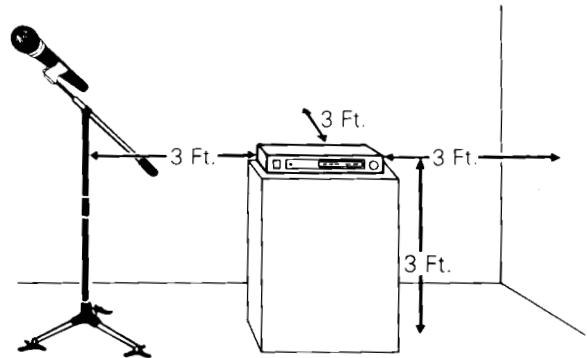

Fig. A Receiver Location

Location

For best operation the receiver should be at least 3 ft. above the ground and at least 3 ft. away from a wall or metal surface to minimize reflections. The transmitter should also be at least 3 ft. away from the receiver, as shown in Figure A.

Keep antennas away from noise sources such as motors, automobiles, and neon lights, as well as large metal objects.

Output Connections

There are two audio outputs on the back of the receiver: balanced (160 mV) and unbalanced (280 mV). Use shielded audio cable for the connection between the receiver and the mixer. If the input of the mixer is a 1/4" jack, connect a cable from the 1/4" unbalanced audio output on the back of the receiver to the mixer. If the input of the mixer is an XLR-type input, connect a cable from the balanced XLR-type audio output on the back of the receiver to the mixer.

The two isolated audio outputs permit simultaneous feeds to both unbalanced and balanced inputs. For example, both a guitar amp and a mixer can be driven by the receiver.

Antennas

Attach the antennas to the antenna input jacks.

Power Connections

Connect the included AD1205A AC adapter to the DC power input on the back of the receiver. Then plug the adapter into a standard 120 volt 60 Hz AC power outlet.

Receiver Controls and Functions

Fig. B Receiver Front Panel

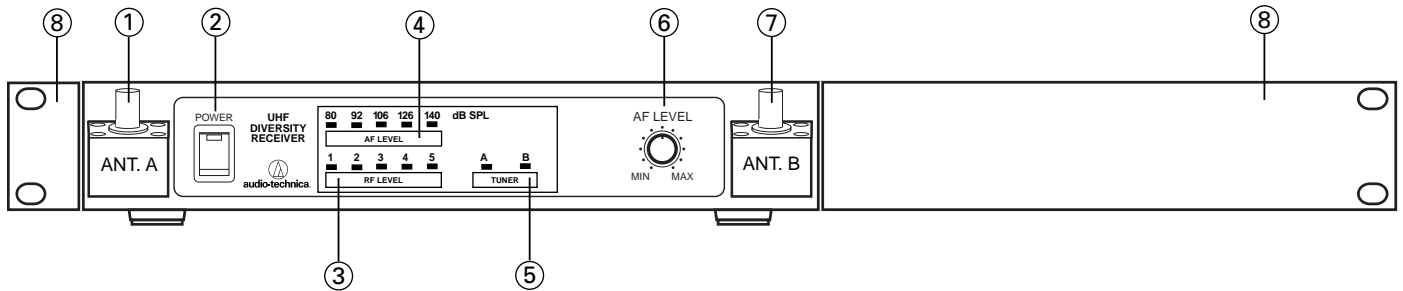
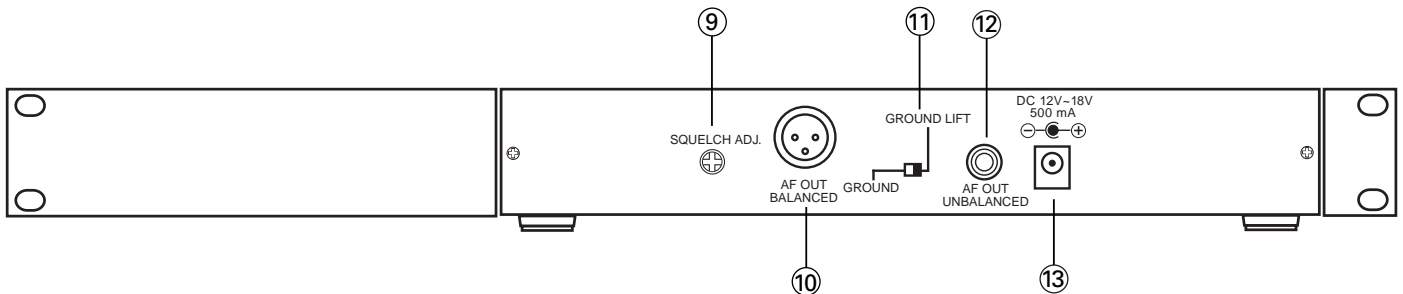

Fig. C Receiver Rear Panel



Front Panel Controls and Functions (Fig. B)

1. TUNER "A" ANTENNA JACK: Antenna connector for tuner "A." Attach the antenna directly, or extend it with an antenna cable.
2. POWER SWITCH/INDICATOR: Press switch on, and the "Power" indicator will light.
3. RF SIGNAL LEVEL INDICATOR: Indicates the strength of the RF signal received from the transmitter. The LEDs will light up from left to right.
4. AF LEVEL INDICATOR: Indicates the audio modulation level of the received signal. (Not affected by the setting of the AF Level control.)
5. TUNER OPERATION INDICATOR: Indicates which tuner has the better reception and is in operation.
6. AF LEVEL CONTROL: Adjusts the level at both audio output jacks.
7. TUNER "B" ANTENNA JACK: Antenna connector for tuner "B." Attach the antenna directly, or extend it with an antenna cable.
8. MOUNTING ADAPTERS: For mounting the receiver in any standard 19" rack. Attach to receiver with screws supplied.

Rear Panel Controls and Functions (Fig. C)

9. SQUELCH CONTROL: Adjusts level of noise-muting circuit (preset at factory but can be adjusted as circumstances warrant).
10. BALANCED AUDIO OUTPUT JACK: XLRM-type connector. A standard 2-conductor shielded cable can be used to connect the receiver output to a balanced aux-level input on a mixer.
11. GROUND LIFT SWITCH: Disconnects the ground pin of the balanced output (10) from ground. Normally, the switch should be to the left (ground connected). If hum caused by a ground loop occurs, slide switch to the right.
12. UNBALANCED AUDIO OUTPUT JACK: 1/4" phone jack. Can be connected to an unbalanced aux-level input of a mixer or tape recorder.
13. DC POWER INPUT: For the provided AD1205A AC adapter, or other 12-18V DC source. (Receiver requires 500 mA.)

Transmitter Setup

Battery Selection

An alkaline 9-volt battery is recommended.

UniPak™ Transmitter Battery Installation

1. Slide off the battery cover as shown in Figure D.
2. Carefully insert a fresh 9-volt alkaline battery, observing correct polarity as marked inside the battery compartment. The transmitter housing is designed to prevent incorrect installation of the battery. **Do not force the battery in.**
3. Replace the battery cover (Fig. E).

Fig. D

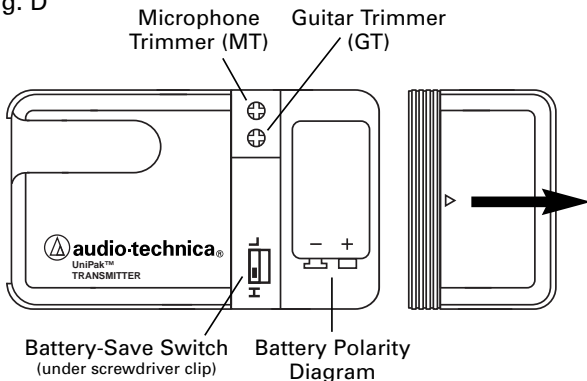
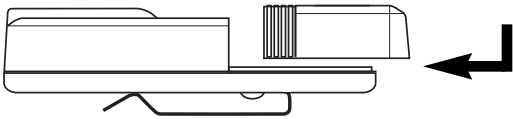

Fig. E



Handheld Transmitter Battery Installation

1. While holding the upper part of the transmitter body just below the ball-screen, unscrew the lower body cover and slide it downward to expose the battery compartment.
2. Lift the white "battery keeper" arm, and insert a 9V battery. Be certain to observe correct polarity as marked inside the battery compartment (Fig. F). The transmitter housing is designed to prevent incorrect installation of the battery. **Do not force the battery in.**
3. Replace the lower body cover. **Do not overtighten.**

Fig. F

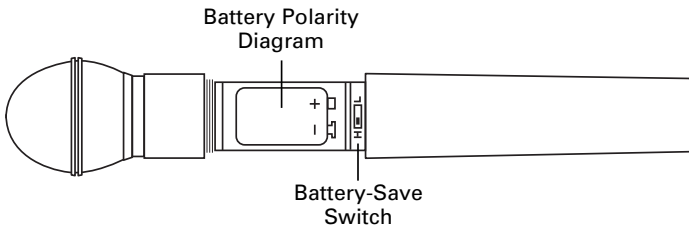
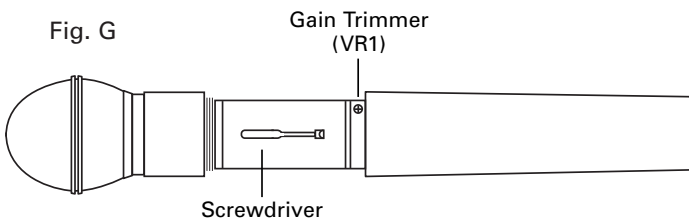

Fig. G



Battery Condition Indicator

The red battery condition indicator (Fig. H/I) should light strongly with a fresh battery. As the battery weakens, the indicator will grow dimmer. When the indicator becomes very dim or goes out, there is little life left in the battery. Replace it at once for continued operation of the transmitter.

Battery-Save Switch

All transmitters feature battery-save switches (Fig. D/F). As supplied, the switch is set in the "H" (high) position for maximum range. Switching to the "L" (low) position increases battery life by reducing power. (Note: Effective range decreases when the switch is set at the "L" position.)

Fig. H

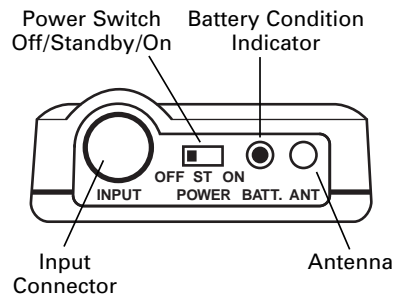
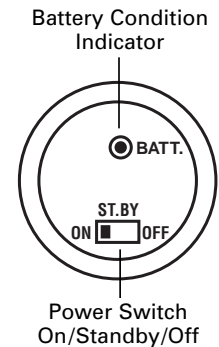

Fig. I



UniPak Transmitter Input Connection

Connect an audio input device (microphone or guitar cable) to the audio input connector on the bottom of the transmitter. A number of Audio-Technica professional microphones and cables are available separately, pre-terminated with a UniPak input connector (see "Optional System Accessories" on page 6.)

Transmitting Antenna

The UniPak transmitter includes a permanently-attached flexible antenna. For best results, allow the antenna to hang freely and full length from the bottom of the transmitter. If the received signal is marginal, experiment with different transmitter positions on your body or instrument; or try repositioning the receiver. **Do not attempt to remove, replace or change the length of the transmitting antenna.**

System Operation

Check the frequency of the system against the chart on page 7 to ensure you have the proper frequency for your area. Operating frequency is shown on the back panel of the receiver and on the transmitter.

Turn down the AF Level control of the receiver as well as the mixer. Switch on the receiver only. Do **not** switch on the transmitter yet.

Receiver On . . .

The power indicator will light up.

Transmitter On . . .

The transmitters have a 3-position power switch. When the switch is set to "Standby," the transmitter produces RF with no audio signal. When the switch is "On," the transmitter produces both RF and audio.

Receiver Squelch

The squelch control on the back of the receiver is preset at the factory, but can be adjusted if you must use the system in an area with considerable RF interference. If there is audio output from the receiver when **your** transmitter is **off**, adjust the squelch control so the system will receive the signal from **your** transmitter but "squelch" or eliminate the unwanted background RF noise. This adjustment can cause a reduction in useable range of the wireless transmitter, so set the control to the **lowest** position that reliably mutes the unwanted RF signals.

Input Level Adjustment

Input trimmer controls in the transmitters enable you to use microphones or guitars with different sensitivities, or to adjust for different acoustic levels.

Adjusting Input Levels – UniPak Transmitter

Slide the battery cover off the top part of transmitter and remove the screwdriver from its clip (Fig. D). Gently turn the "MT" (mic trimmer) and "GT" (guitar trimmer) controls to their full counter-clockwise positions.

CAUTION! *The small trimmer controls are delicate; use only the supplied screwdriver. Do not force the trimmers beyond their normal 180° range of rotation.*

Return the screwdriver to its storage clip when not in use.

• Microphone: Adjusting input level

While speaking/singing into the microphone at typically-loud levels, carefully turn the MT control clockwise while watching the receiver's AF Level indicator. Increase the MT control setting until the **maximum** audio output of the mic lights about three or four LED units on the receiver's AF Level indicator. Do not set the level too high (indicated by the red LED lighting). At normal audio levels, only the first two or perhaps three LEDs should light. (*When using a guitar, return the MT control setting to minimum.*)

• Guitar/Instrument: Adjusting input level

While playing at typically-loud levels, carefully turn the GT control clockwise while watching the receiver's AF Level indicator. Increase the GT control setting until the **maximum** audio output lights about three or four LED units on the receiver's AF Level indicator. Do not set the level too high (indicated by the red LED lighting). At normal audio levels, only the first two or perhaps three LEDs should light. (*When using a microphone, return the GT control setting to minimum.*)

After adjusting input levels, return the screwdriver to its clip and reinstall the battery cover. No further transmitter gain adjustments should be needed, as long as the input device and the acoustic input level are not changed.

Adjusting Input Level – Handheld Transmitter

Unscrew the lower body cover and slide it downward, exposing the screwdriver and gain trimmer (Fig. G). Remove the screwdriver and **gently** turn the gain trimmer control to its full counter-clockwise position.

While speaking/singing into the microphone at typically-loud levels, carefully turn the trimmer control clockwise while watching the receiver's AF Level indicator. Increase the control setting until the **maximum** audio output of the mic lights about three or four LED units on the receiver's AF Level indicator. Do not set the level too high (indicated by the red LED lighting). At normal audio levels, only the first two or perhaps three LEDs should light.

Return the screwdriver to its clip and close and secure the lower body. (Make certain that the white "battery keeper" arm is inside the body.) No further transmitter gain adjustments should be needed, as long as the acoustic input does not change significantly.

Ten Tips To Obtain The Best Results

1. Use only fresh alkaline batteries. Do not use "general purpose" (carbon-zinc) batteries.
2. Position the receiver so that it has the fewest possible obstructions between it and the normal location of the transmitter. Line-of-sight is best.
3. The transmitter and the receiver should be as close together as conveniently possible, but no closer together than three feet.
4. The receiver antennas should be in the open and away from any metal.
5. A receiver cannot receive signals from two transmitters at the same time.
6. In the UniPak transmitter, the "MT" or "GT" input control *not* in use should be set to *minimum*.
7. For best operation, all the RF Level LEDs should be lit (maximize RF input); but only the first two or three AF Level LEDs should be lit (don't overmodulate).
8. If the AF Level control of the receiver is set too high, it may over-drive the input of the mixer or clip the output of the receiver, causing distortion. Conversely, if the receiver output is set too low, the overall signal-to-noise ratio of the system may be reduced. Adjust the output level of the receiver so the highest sound pressure level going into the microphone (or the loudest instrument playing level) causes no input overload in the mixer, and yet permits the mixer level controls to operate in their "normal" range (not set too high or too low). This provides the optimum signal-to-noise for the entire system.
9. Turn the transmitter off when not in use. Remove the battery if the transmitter is not to be used for a period of time.
10. In multiple-system applications, set the battery-save switches on Low if possible, to reduce the chance of intermodulation problems.

Specifications†

OVERALL SYSTEM

Operating Frequency	UHF band, 732 MHz to 746 MHz
Frequency Stability	±0.005%
Modulation Mode	FM
Maximum Deviation	±15 kHz
Operating Range	200' minimum
Operating Temperature Range	40° F (4° C) to 110° F (43° C)
Frequency Response	100 Hz to 15 kHz

RECEIVER

Receiving System	Dual independent receivers, automatic-switching diversity reception
Image Rejection	45 dB minimum
Signal-to-noise Ratio	95 dB at 10 kHz deviation (IEC-weighted), maximum modulation 15 kHz
Total Harmonic Distortion	≤1% (10 kHz deviation at 1 kHz)
Sensitivity	≤20 µV for 60 dB S/N (IEC-weighted)
Audio Output	
Unbalanced	280 mV (at 1 kHz, ±10 kHz deviation, 10k ohm load)
Balanced	160 mV (at 1 kHz, ±10 kHz deviation, 10k ohm load)
Output Connectors	
Unbalanced	1/4" phone jack
Balanced	XLRM-type
Power Supply	12-18V DC, 500 mA
Dimensions	8.27" (210.0 mm) W x 1.93" (49.0 mm) H x 9.88" (251.0 mm) D
Weight	2.9 lbs (1.3 kgs)
Accessories Included	Two antennas, rack mount adapters, AD1205A AC adapter

UNIPAK™ TRANSMITTER

RF Power Output	50 mW Max
Spurious Emissions	Under federal regulations
Dynamic Range	≥90 dB
Input Connections	High impedance, low impedance, bias
Battery	9V (NEDA type 1604) alkaline, not included
Current Consumption	50 mA typical
Battery Life	Approximately 8 hours in High position Approximately 10 hours in Low position
Dimensions	2.56" (65.0 mm) W x 4.33" (110.0 mm) H x 1.00" (25.4 mm) D
Net Weight (without battery)	3.2 oz (90 grams)

HANDHELD TRANSMITTER

RF Power Output	50 mW Max
Spurious Emissions	Under federal regulations
Dynamic Range	≥90 dB
Microphone Element	Dynamic unidirectional
Battery	9V (NEDA type 1604) alkaline, not included
Current Consumption	50 mA typical
Battery Life	Approximately 8 hours in High position Approximately 10 hours in Low position
Dimensions	9.53" (242.0 mm) long, 2.13" (54.0 mm) diameter
Net Weight (without battery)	12.3 oz (350 grams)
Accessory Included	AT8431 stand clamp

† In the interest of standards development, A.T.U.S. offers full details on its test methods to other industry professionals on request.

Optional System Accessories

MICROPHONES AND CABLES

AT829cW	AT829 miniature cardioid condenser microphone only, terminated for use with UniPak transmitter. Includes clothing clip and windscreen.
MT830cW	MT830R subminiature omnidirectional condenser microphone only, terminated for use with UniPak transmitter. Includes clothing clip and windscreen.
MT830cW-TH	"Theater" model, same as MT830cW except beige color mic and cable for concealment.
AT831cW	AT831b miniature cardioid condenser microphone only, terminated for use with UniPak transmitter. Includes clothing clip and windscreen.
AT851cW	AT851a surface-mount wide-range hemi-cardioid condenser microphone only, terminated for use with UniPak transmitter.
AT857AMLcW	AT857AML 19" gooseneck cardioid microphone only, terminated for use with UniPak transmitter. Mounts to 5/8"-27 thread. Includes windscreen.
ATM35cW	ATM35 high-intensity cardioid condenser microphone only, terminated for use with UniPak transmitter. Includes AT8418 clip-on instrument mount.
ATM73cW	ATM73a headworn cardioid condenser microphone only, terminated for use with UniPak transmitter.
ATM75cW	ATM75 headworn cardioid condenser microphone only, terminated for use with UniPak transmitter. Includes windscreens and cable clip.
PRO 8HEcW	PRO 8HEX headworn hypercardioid dynamic microphone, terminated for use with UniPak transmitter. Includes windscreen and cable clip.

PRO 35xcW	PRO 35x cardioid condenser microphone only, terminated for use with UniPak transmitter. Includes AT8418 clip-on instrument mount.
AT-GCW	Hi-Z instrument/guitar cable with 1/4" phone plug, terminated for use with UniPak transmitter.
XLRW	Connecting cable for UniPak transmitter with an XLR-type input connector, for Lo-Z microphones with XLRM-type output terminations.

TRANSMITTER ACCESSORIES

ATW-VP10	Vinyl pouch with belt clip to hold UniPak transmitter.
AT8114	Foam windscreen for handheld transmitter.
AT8141	Water-resistant pouch for UniPak transmitter.
AT8431	Stand clamp for handheld transmitter, 5/8"-27 threads.

RECEIVER ACCESSORIES

AT8628	Mounting plate adapter allows rack-mounting two ATW-R14 receivers side-by-side in a single 19" rack space.
ATW-D70	UHF (728-750 MHz) unity-gain antenna distribution system provides two "1-in, 4-out" RF channels; connects a pair of antennas to as many as four diversity receivers. Includes four DC interconnect cables to power up to four ATW-R14 receivers, eight RF output cables and two rack-mount adapters. Mounts in a single (1U) 19" rack space.

Wireless Operating Frequencies

Frequency Selection

Each transmitter/receiver system operates on a single factory-aligned, crystal-controlled frequency. Available frequencies are shown in the chart below.

Because the 732-746 MHz frequencies are shared with TV broadcasting, frequency selection is partially dependent upon which TV broadcast channels are in operation *where the wireless system is to be used*.

Operating frequency is specified by a three-character code, such as "57V," in addition to the actual frequency in MHz. The frequency of each transmitter appears on a label on the outside of the unit. The frequency of each receiver appears on a label on the back of the unit and the frequency of each system appears on the outer carton. For future reference, please record them in the space provided below.

RF Interference

If you encounter receiving interference (from other than an operating TV station), often it can be eliminated by adjusting the receiver's squelch control, as described on page 5.

Please note that wireless frequencies are shared with other radio services. According to Federal Communications Commission regulations, "Wireless microphone operations are unprotected from interference from other licensed operations within the band. If any interference is received by any Government or non-Government operation, the wireless microphone must cease operation..."

If you need assistance with operation or frequency selection, please contact your dealer or the A-T professional division. Extensive wireless information also is available on the A-T Web site at www.audio-technica.com.

System Operating Frequencies

UHF TV Band (732-746 MHz)

	Freq. Code	Freq. (MHz)
• For use only where there is no TV Channel 57:	57R	732.650
	57V	733.000
• For use only where there is no TV Channel 58:	58F	735.600
	58G	735.950
	58K	736.650
	58L	737.000
• For use only where there is no TV Channel 59:	59K	742.700
	59Q	744.100
	59R	744.850
	59S	745.200

Aside from the TV channel restrictions above, multi-channel systems may combine up to all 10 frequencies. Due to the unique conditions encountered in any complex system, the following guidelines may be helpful:

- Use the Low-power transmitter setting to reduce the possibility of interference.
- Maintain the maximum possible spacing between transmitters and receivers, and between transmitters.
- 1400 Series operating frequencies have been selected for optimum compatibility. However, *other* sources of RF energy can affect the overall performance of the multi-mic system in ways which cannot be predicted. Only on-site trials with *all* RF equipment in operation can determine the overall system functionality.

For future reference, please record your system information here (the serial numbers appear inside the battery compartment of each transmitter, and on the bottom of each receiver):

Operating Frequency

Freq. Code _____ Frequency _____ • _____ MHz

Receiver

Model _____ Serial Number _____

Transmitter

Model _____ Serial Number _____

One-Year Limited Warranty

Audio-Technica professional wireless systems purchased in the U.S.A. are warranted for one year from date of purchase by Audio-Technica U.S., Inc. (A.T.U.S.) to be free of defects in materials and workmanship. In event of such defect, product will be repaired promptly without charge or, at our option, replaced with a new product of equal or superior value if delivered to A.T.U.S. or an Authorized Service Center, prepaid, together with the sales slip or other proof of purchase date. **Prior approval from A.T.U.S. is required for return.** This warranty excludes defects due to normal wear, abuse, shipping damage, or failure to use product in accordance with the instructions. This warranty is void in the event of unauthorized repair or modification, or removal or defacing of the product labeling.

For return approval and shipping information, contact the Service Dept., Audio-Technica U.S., Inc., 1221 Commerce Drive, Stow, Ohio 44224.

Except to the extent precluded by applicable state law, **A.T.U.S. will have no liability for any consequential, incidental, or special damages; any warranty of merchantability or fitness for particular purpose expires when this warranty expires.**

This warranty gives you specific legal rights, and you may have other rights which vary from state to state.

Outside the U.S.A., please contact your local dealer for warranty details.

Notice to individuals with implanted cardiac pacemakers or AICD devices:

Any source of RF (radio frequency) energy *may* interfere with normal functioning of the implanted device. All wireless microphones have low-power transmitters (less than 0.05 watts output) which are unlikely to cause difficulty, especially if they are at least a few inches away. However, since a "body-pack" mic transmitter typically is placed against the body, we suggest attaching it at the belt, rather than in a shirt pocket where it may be immediately adjacent to the medical device. Note also that *any medical-device disruption will cease when the RF transmitting source is turned off.* Please contact your physician or medical-device provider if you have any questions, or experience any problems with the use of this or any other RF equipment.

